

2020  
general catalogue

# Daily stories

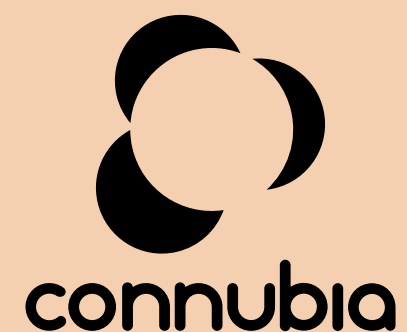



I prodotti Connubia hanno un design semplice,  
funzionale, dove il colore esprime vitalità e personalità.

Prodotti che vorranno essere rispettosi dell'ambiente utilizzando  
sempre di più materiali ecosostenibili a basso impatto ambientale.

Non solo sedie e tavoli, ma anche complementi, accessori e  
mobili contemporanei che siano capaci di adattarsi a contesti diversi  
e di creare spazi di ispirazione per la vita, il lavoro e la comunità.

Prodotti che possano raccontare storie di ogni giorno,  
perché è proprio dallo stare seduti insieme intorno ad un tavolo che  
nascono incontri, condivisioni ed emozioni che Connubia  
mette al centro della propria ispirazione.

*Connubia products design is simple, functional and  
their color expresses vitality and personality.*

*They are products that wish to respect the environment by using more  
and more eco-sustainable and low environmental impact materials.*

*Not only chairs and tables, but also occasional furniture, accessories  
and contemporary sideboards able to adapt to different contexts and  
to create inspirational spaces for living, working and for the community.*

*Products able to tell everyday stories because it is, indeed, from sitting  
together around a table that meetings, sharing and emotions begin,  
Connubia puts all this at the center of its inspiration.*

Daily stories

Il simbolo si compone di tre semicerchi disposti in circolo attorno a un cerchio più grande che si crea per illusione ottica. Tre sedie attorno a un tavolo; la rappresentazione più immediata e sintetica dell'incontro, della convivialità, dell'idea di stare insieme.

*The symbol is made up of three semi-circles set around a bigger circle which comes into being as a result of an optical illusion. Three chairs around a table - there could be no more instantly-recognisable symbol of a social occasion, companionship and togetherness.*

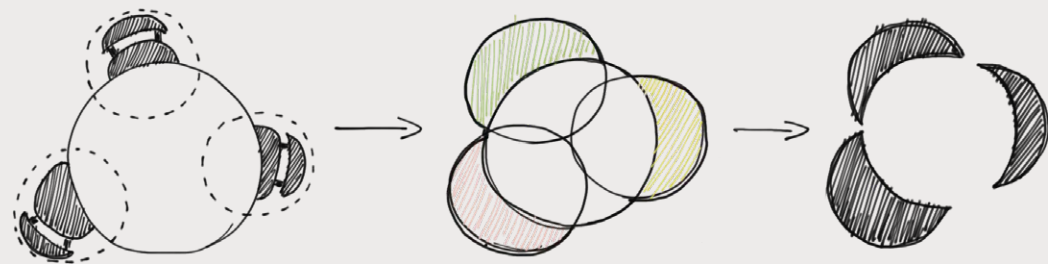

“Connubia vuole dialogare con il mondo contemporaneo, fatto di persone ben disposte all'evoluzione naturale delle cose ed al cambiamento. Una generazione “giovane” che si adatta ad ogni nuova direzione del mondo, che non ha preconcetti e vive con forte personalità la moda ed il proprio lavoro che ogni giorno cambia.

Connubia vuole essere colore e vitalità, non segue uno stile, ma vuole essere diversa ogni giorno, di tendenza e “prêt à porter”.

Volete unirvi a noi? Creiamo insieme la nostra #connubity!”

*“Connubia wants to communicate with the contemporary world made of people open to the natural progression of things and welcoming of change. A ‘youthful’ generation which adapts with ease to a shifting world; a generation devoid of preconceptions, which tackles the fluctuations of fashion and altering demands of work with a strong sense of identity.*

*Connubia wants to be colour and verve; it doesn't follow a given style because wants to look different every day, trendy and ‘prêt à porter’.*

*Do you want to join us? Let's create our own #connubity!”*

*Cristian Gori  
ARCHIRIVOLTO Senior Designer  
“Connubity” Member #1*

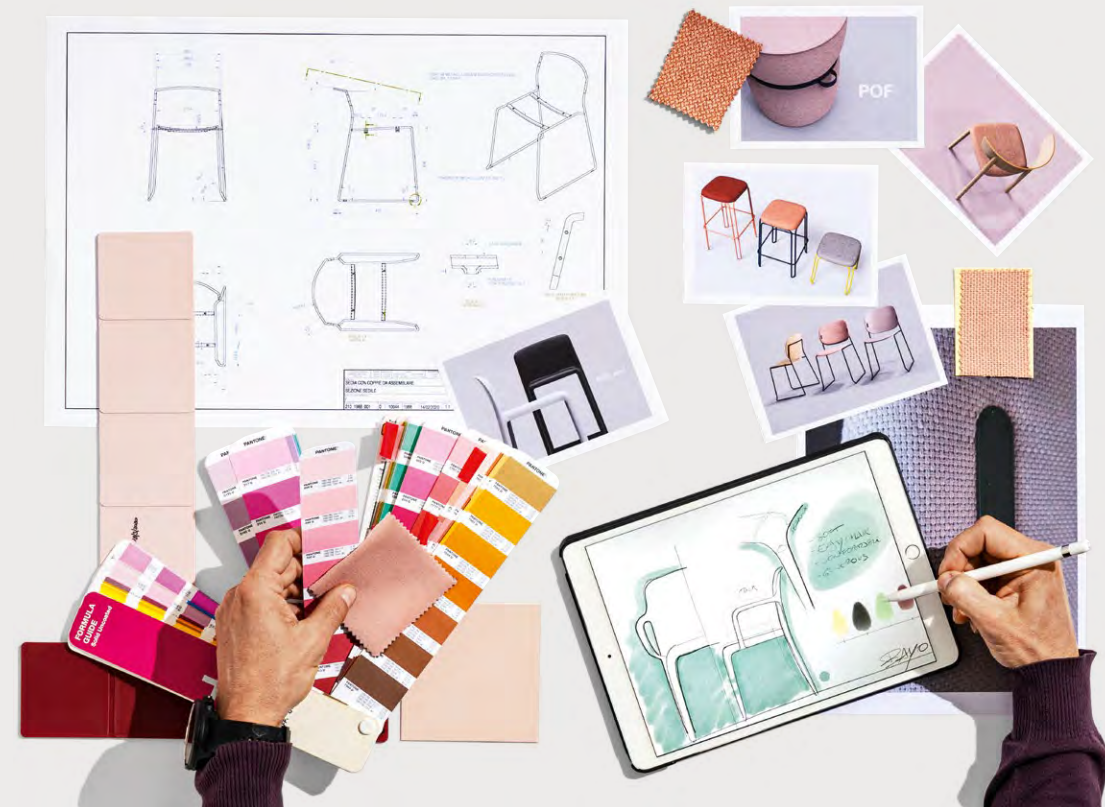

## LEGENDA | KEY



SEDIA IMPILABILE  
Stackable chair



ADATTO AD USO ESTERNO  
For outdoor use



SFODERABILE  
Removable



REGOLABILE IN ALTEZZA  
Adjustable height



SEDUTA GIREVOLE A 360°  
360° swivelling chair



SEDUTA GIREVOLE CON  
MECCANISMO DI RITORNO  
Swivelling base features  
a self returning mechanism



PUSH & PULL  
Push & Pull mechanism

MANUAL  
x-tension

ALLUNGA MANUALE  
tavolo allungabile con  
meccanismo manuale; le  
allunghe vengono sollevate  
e posizionate all'altezza del  
piano principale.  
MANUAL EXTENSION  
extendable table with manual  
mechanism; the extensions  
are manually lifted and aligned  
with the top.

EASY  
x-tension

ALLUNGA SEMI-AUTOMATICA  
tavolo allungabile con  
meccanismo semi automatico;  
le allunghe vengono  
posizionate agevolmente  
traslando su apposite guide.  
SEMI-AUTOMATIC EXTENSION  
extendable table with semi-  
automatic mechanism; the  
extensions are easily aligned  
with the top by gliding on special  
runners.

MAGIC  
x-tension

ALLUNGA AUTOMATICA  
tavolo allungabile con  
meccanismo automatico;  
le allunghe si posizionano  
autonomamente all'altezza del  
piano principale.  
AUTOMATIC EXTENSION  
extendable table with automatic  
mechanism; the extensions will  
automatically align with the top.

Le pagine di questo catalogo propongono una serie di abbinamenti sedie, tavolo, complementi. Sono solo suggerimenti: sarà il gusto personale a determinare le scelte. I marchi e i segni distintivi riportati nel presente listino/catalogo sono validamente registrati e di esclusiva proprietà della Calligaris S.p.A. Il rivenditore si obbliga a utilizzare correttamente il materiale promozionale e pubblicitario fornito dalla Calligaris S.p.A., senza, in alcun modo, ledere i marchi e i segni distintivi in esso riportati.

The pages of this catalogue show only a number of furniture combinations. These are our suggestions: only your personal taste will determine your final choice. The distinctive marks and trademarks contained in this price list/catalogue are validly registered and are the sole property of Calligaris S.p.A. The retailer is obliged to correctly use the promotional and advertising material supplied by Calligaris S.p.A., without damaging in any way the distinctive marks and trademarks contained therein.



MODELLO CERTIFICATO FOREST  
STEWARDSHIP COUNCIL®  
Forest Stewardship Council® certified Model  
RICHIEDI I PRODOTTI CERTIFICATI FSC-COC  
Ask for FSC® certified products



Natur Sphere®  
TESSUTO ANTIMACCHIA  
Stain resistant fabric

Silver Protection  
TESSUTO CON TRATTAMENTO  
ANTI-BATTERICO E ANTI-FUNGO  
Fabric featuring an antibacterial  
and antifungal treatment



TRATTAMENTO SUPERFICIALE CHE  
RITARDA L'ASSORBIMENTO DELLE  
MACCHIE A BASE ACQUOSA.  
Surface treatment, which delays the  
absorption of water based stains.

# COME LEGGERE IL CATALOGO | HOW TO READ THE CATALOGUE

- 1 Nome del modello  
Model name
- 2 Codice del modello e  
misure (LxP H cm)  
Model code and  
dimensions (WxD H cm)
- 3 Finitura della struttura  
Frame finish
- 4 Finitura del sedile  
Seat finish
- 5 Nome della stoffa  
Fabric name
- 6 Note tecniche  
Technical details
- 7 Tipologia dei prodotti  
Product type

## New York 1



### struttura frame 3

metallo | metal



### sedile seat 4

tessuto | fabric



similpelle | faux leather

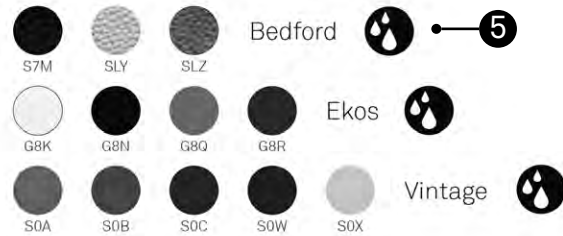

pelle | soft leather

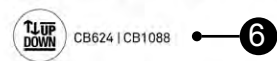

NOTA per le combinazioni disponibili consultare il listino prezzi. | NOTE please check all available combinations in the price list.

## 7 sedie e sgabelli | chairs and stools



New York CB1022 sedia | chair  
metallo P94 bianco ottico opaco / similpelle Bedford SLY sale  
metal P94 matt optic white / Bedford faux leather SLY salt white



# DISCOVER THE NEW CONNUBIA COLLECTION!

Colour is the mood! La nuova Connubia si veste di colore per creare una collezione piena di vitalità e freschezza. A sedie e tavoli, fondamentali della gamma, si affiancano ora nuove categorie di prodotto come librerie, madie, accessori che completano e personalizzano con la loro allegria gli spazi da vivere. Nuovi modelli fedeli allo spirito di Connubia per semplicità di linee, funzionalità e versatilità, ma ricchi di personalità. Nella nuova collezione Connubia sono state inserite famiglie di prodotto molto ampie in cui il tratto distintivo di ogni modello accomuna i vari pezzi. È per questo che abbiamo deciso di presentare i nuovi modelli divisi per famiglia di prodotto e non per categoria, dando così modo al lettore di apprezzare al meglio la nuova collezione ed il suo sviluppo.

*Colour is king! New Connubia takes on colourful raiment for a collection loaded with refreshing verve. Chairs and tables, the essentials of the range, now stand alongside new product categories such as bookshelves, sideboards and accessories that complete and personalise living spaces with an upbeat feel. New models which are faithful to the spirit of Connubia with designs that are not only unfussy, functional and versatile but especially characterful. The new Connubia collection includes wide-ranging product families with a distinctive trait that brings each piece under the same umbrella. This is why we have decided to present the new models classified by product family and not by category. This should help readers to gain a better understanding of the new collection and how it developed.*

# App

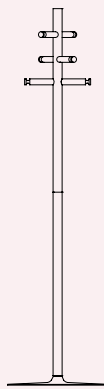

CB5212 | 45x45 H166 cm

## basamento base

metallo | metal

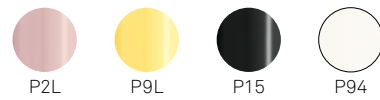

## colonna/ganci column/hooks

legno | wood

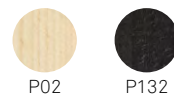

mensole e altri accessori | shelves and other accessories

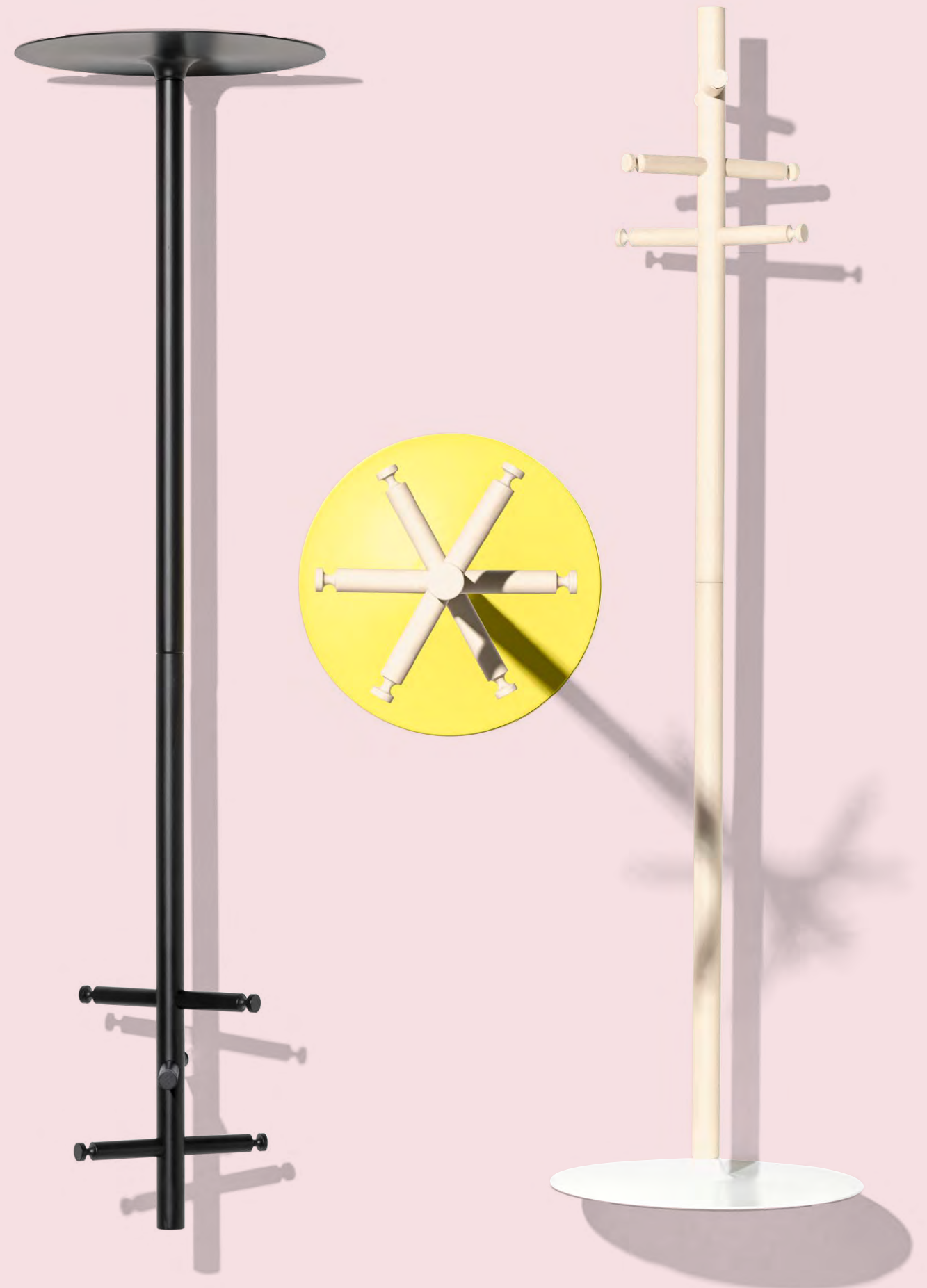



App CB5212 appendiabiti | coat stands / hangers  
faggio P02 faggio sbiancato / metallo P9L limone opaco  
beech P02 bleached beechwood / metal P9L matt lemon yellow

App CB5212 appendiabiti | coat stands / hangers  
faggio P02 faggio sbiancato / metallo P9L limone opaco - P94 bianco ottico opaco  
beech P02 bleached beechwood / metal P9L matt lemon yellow - P94 matt optic white  
faggio P132 faggio grafite / metallo P15 nero opaco  
beech P132 graphite / metal P15 matt black

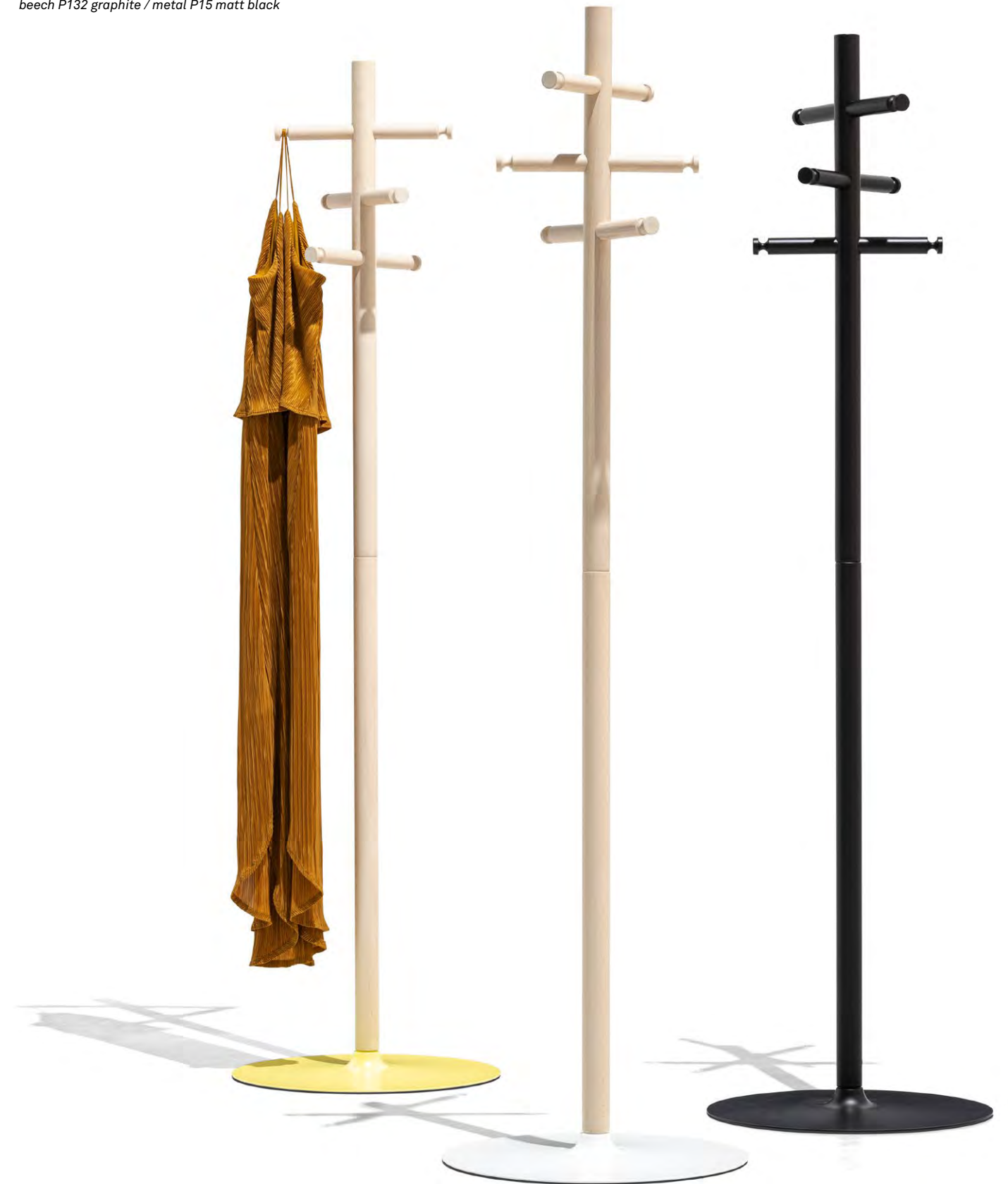



# Baik

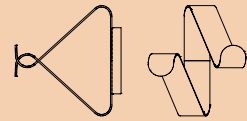

CB5211 | 26,5x29 H30 cm

## struttura frame

metallo | *metal*



P2L

P7L

P9L

mensole e altri accessori | shelves and other accessories

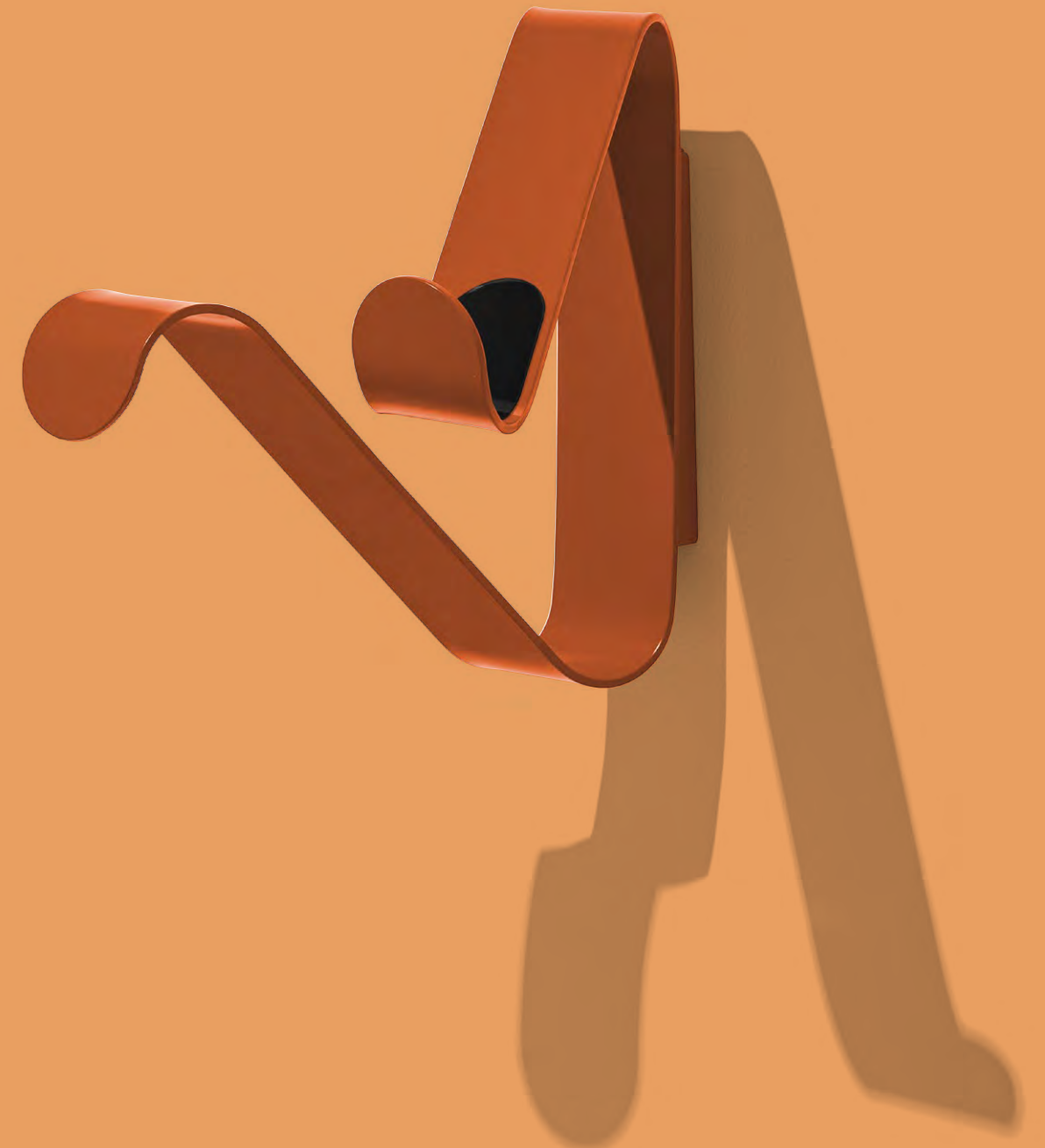

**Baik** CB5211 portabici | *bicycle rack*  
metallo P7L zafferano opaco  
*metal P7L matt saffron yellow*



Baik CB5211 portabici | *bicycle rack*  
 metallo P7L zafferano opaco  
 metal P7L matt saffron yellow

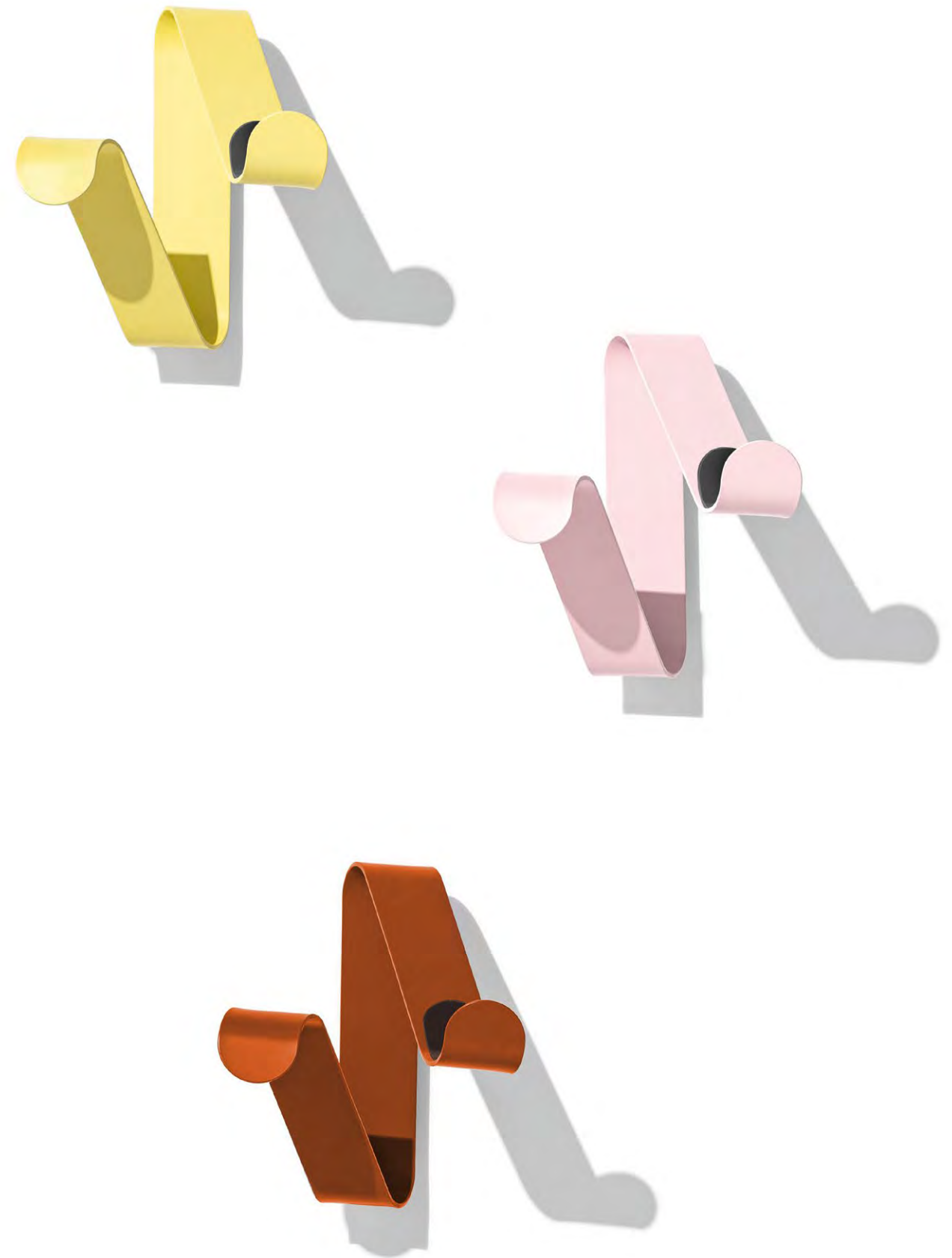

Baik CB5211 portabici | *bicycle rack*  
 metallo P9L limone opaco - P2L cipria opaco - P7L zafferano opaco  
 metal P9L matt lemon yellow - P2L matt pink - P7L matt saffron yellow

# Bayo

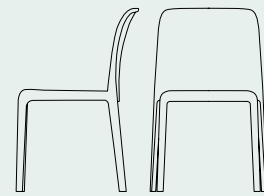

CB1983 | 52x54 H82,5 cm

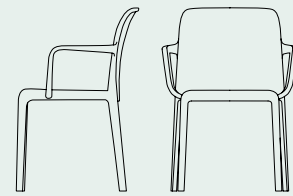

CB2119 | 60x54 H82,5 HB65 cm

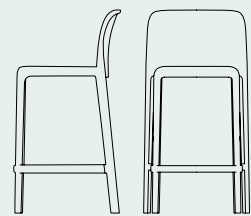

CB1984 | 47x46,5 H90 HS65 cm

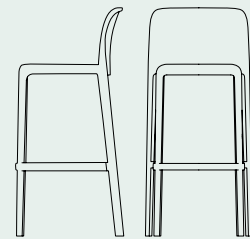

CB1985 | 47x47 H101 HS76 cm

## struttura/sedile frame/seat

PP



sedie e sgabelli | chairs and stools



Bayo CB1983 sedia | chair  
polipropilene P94 bianco ottico opaco  
polypropylene P94 matt optic white

Bayo

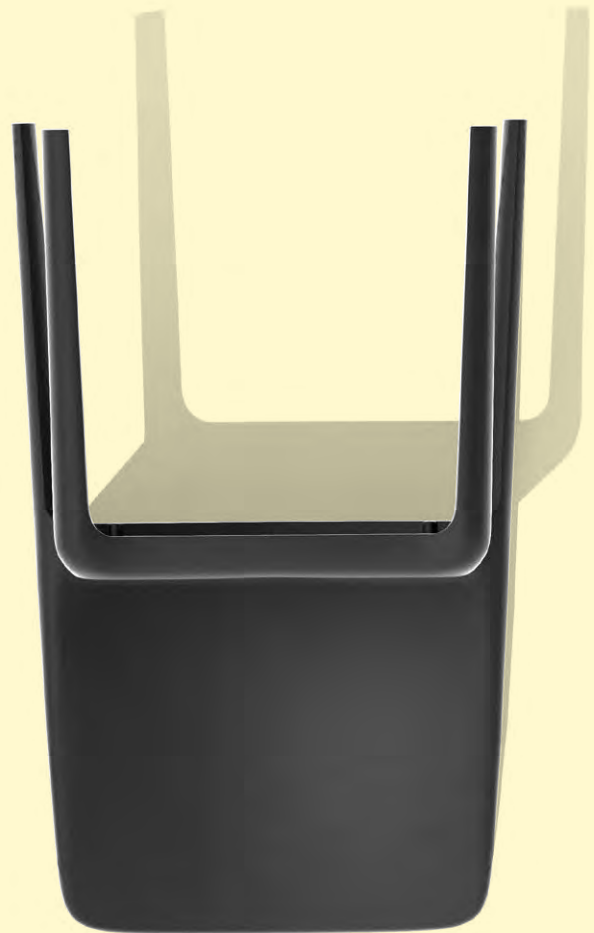
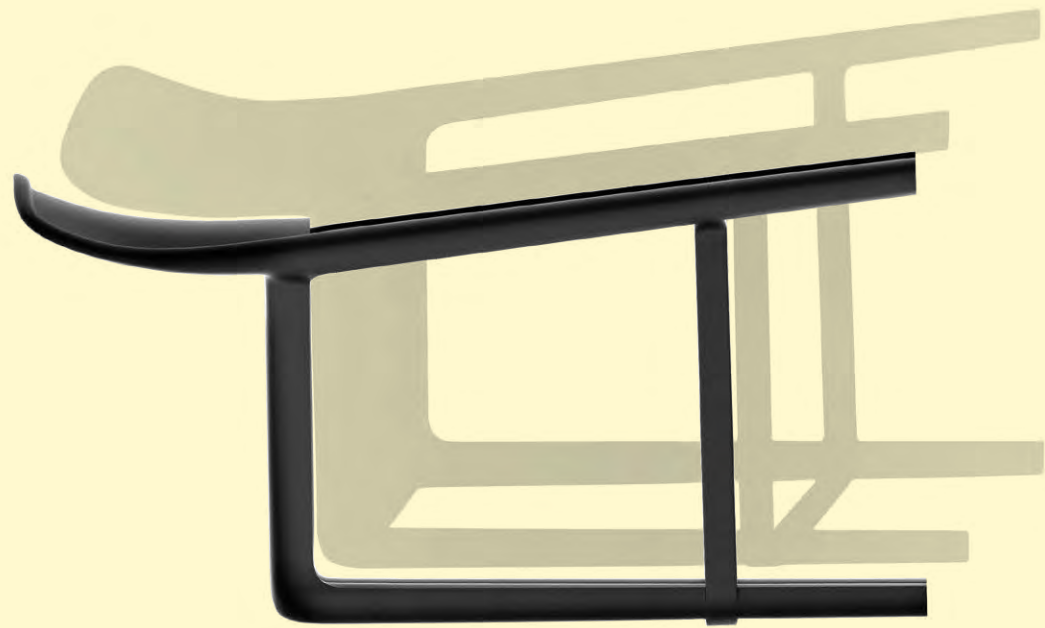

connubia

Bayo sedie e sgabelli in polipropilene |  
polypropylene chairs and stools  
P15 nero opaco | P15 matt black

sedie e sgabelli | chairs and stools

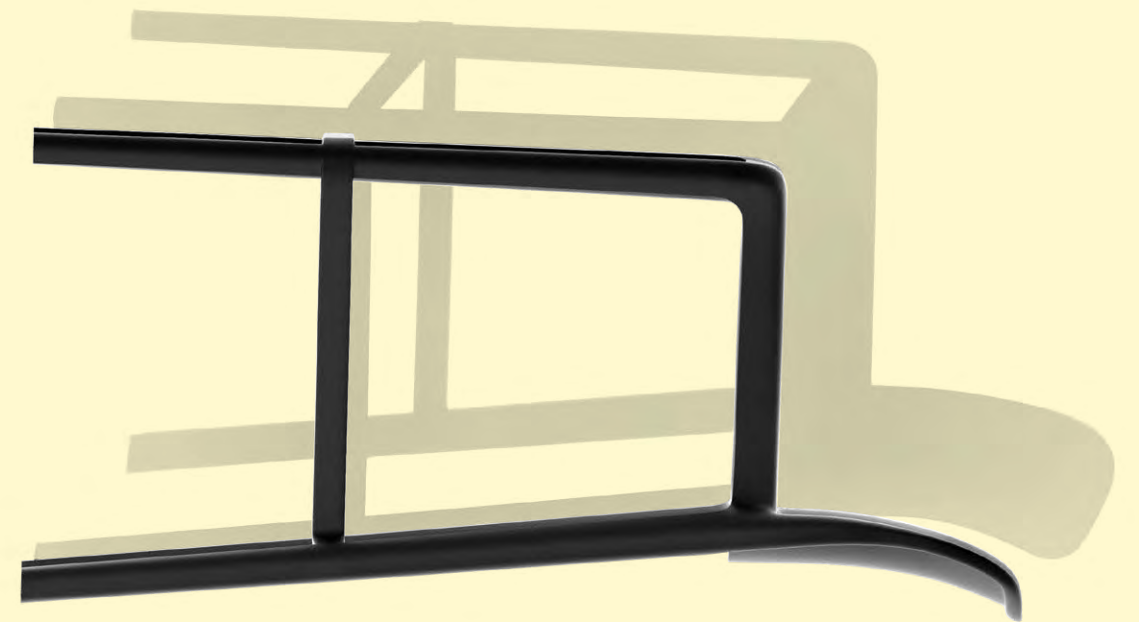

Daily stories



Bayo sedie e sgabelli in polipropilene | polypropylene chairs and stools  
CB2119 P7L zafferano opaco | P7L matt saffron yellow  
CB1983 P94 bianco ottico opaco | P94 matt optic white  
CB1983 P2L cipria opaco | P2L matt pink  
CB1984 P3L rosso ossido opaco | P3L matt oxide red  
CB1985 P8L timo opaco | P8L matt thyme green





Bayo CB2119 sedia | chair  
polipropilene P900 tortora opaco  
polypropylene P900 matt taupe

Bayo CB2119 sedia | chair  
polipropilene P2L cipria opaco  
polypropylene P2L matt pink



# Bibli

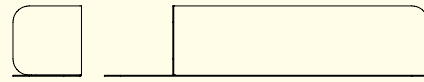

CB5201 | 70x15,5 H15 cm

## struttura frame

metallo | metal

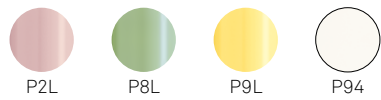

mensole e altri accessori | shelves and other accessories

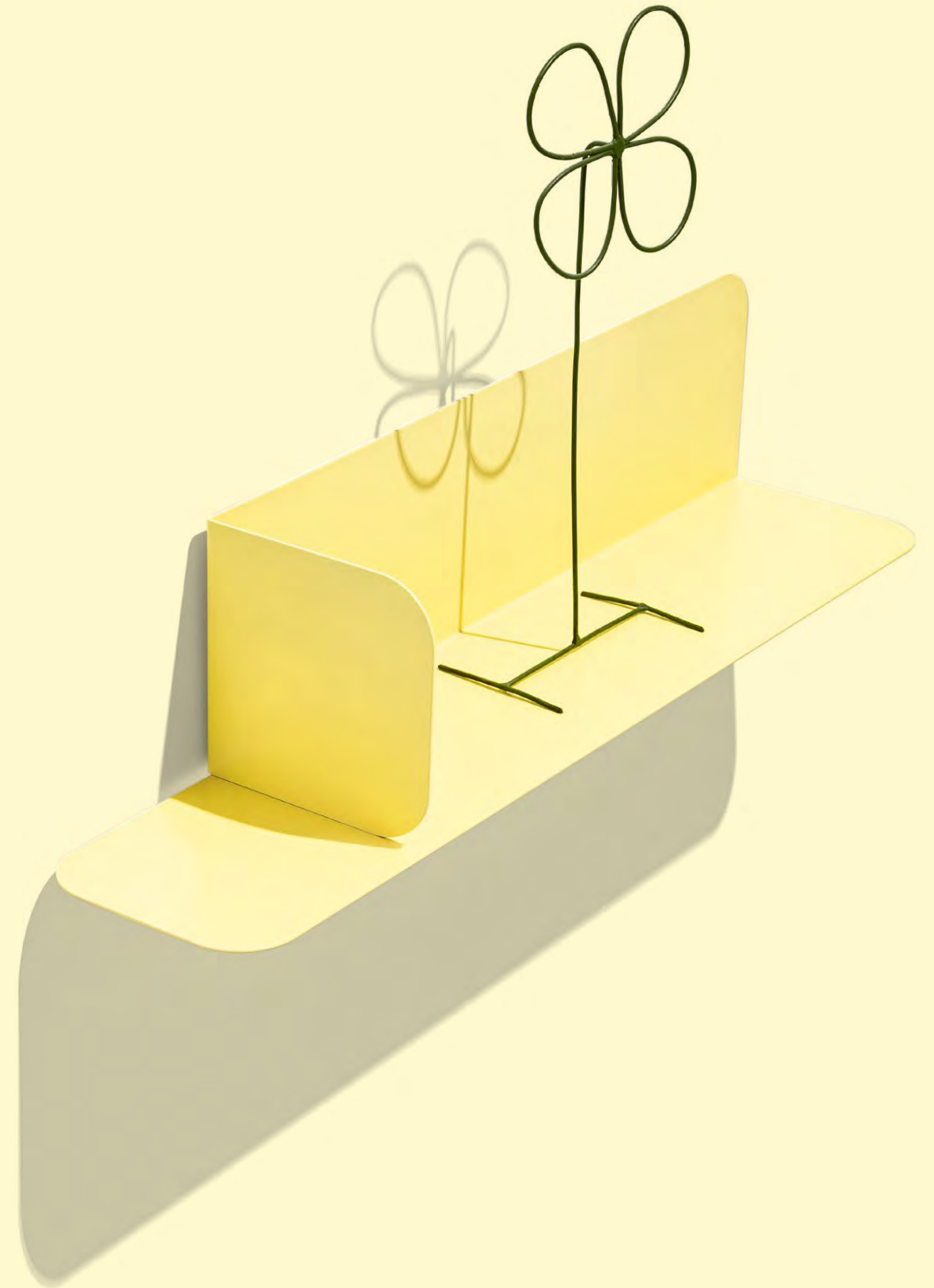

**Bibli** CB5201 mensola | shelf  
metallo P9L limone opaco  
metal P9L matt lemon yellow





Bibli CB5201 mensola | shelf  
 metallo P9L limone opaco  
 metal P9L matt lemon yellow

Bibli CB5201 mensole | shelves  
 metallo P94 bianco ottico opaco - P2L cipria opaco -  
 P8L timo opaco - P9L limone opaco  
 metal P94 matt optic white - P2L matt pink -  
 P8L matt thyme green - P9L matt lemon yellow



# Clelia

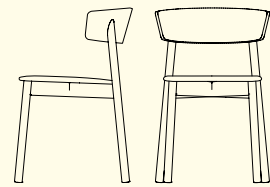

CB2120 | 50x52 H77 cm

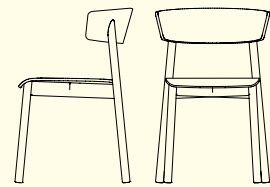

CB2120-A | 50x52 H77 cm

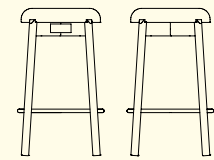

CB2123 | 40x40 H68 cm

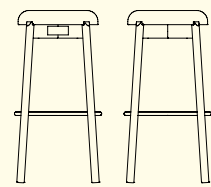

CB2124 | 40x40 H79 cm

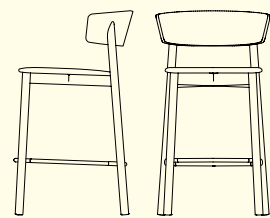

CB2121 | 49x54 H90 HS66 cm

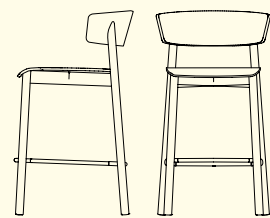

CB2121-A | 49x54 H90 HS65 cm

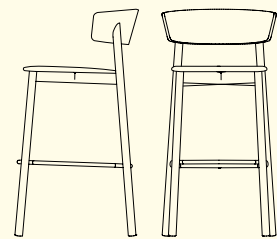

CB2122 | 50x55 H101 HS76 cm

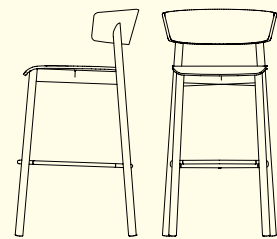

CB2122-A | 50x55 H101 HS75 cm

## struttura frame

legno | wood

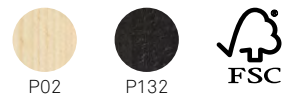

## sedile seat

legno | wood

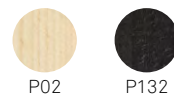

tessuto | fabric

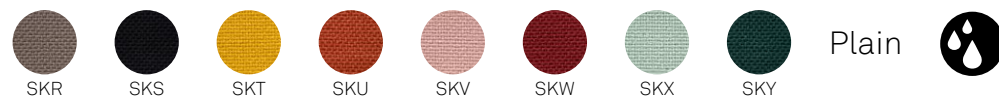

CB2120 | CB2120-A

SGABELLI CON POGGIAPIEDI IN METALLO VERNICIATO NERO OPACO | MATT BLACK VARNISHED METAL FOOTREST

NOTA per le combinazioni disponibili consultare il listino prezzi. | NOTE please check all available combinations in the price list.



**Clelia CB2120 sedia | chair**  
faggio P02 faggio sbiancato / tessuto Plain SKT limone  
beech P02 bleached beechwood / Plain fabric SKT lemon yellow

**Clelia CB2120 sedia | chair**  
 faggio P02 faggio sbiancato / tessuto Plain  
 SKU zafferano - SKT limone - SKV rosa  
*beech P02 bleached beechwood / Plain fabric*  
 SKU saffron yellow - SKT lemon yellow - SKV pink  
**Clelia CB2120-A sedia | chair**  
 faggio P02 faggio sbiancato / multistrato faggio  
 P02 faggio sbiancato  
*beech P02 bleached beechwood / plywood beech*  
 P02 bleached beechwood  
**Tapi CB7224 tappeto | rug**  
 polipropilene/poliestere tonalità beige/giallo/arancio/rosa  
*polypropylene/polyester shades of beige/orange/yellow/pink*





**Clelia CB2123 sgabello | stool**  
faggio P02 faggio sbiancato / tessuto Plain SKU zafferano  
beech P02 bleached beechwood / Plain fabric SKU saffron yellow

**Clelia CB2122 sgabello | stool**  
faggio P02 faggio sbiancato / tessuto Plain SKU zafferano  
beech P02 bleached beechwood / Plain fabric SKU saffron yellow  
**Clelia CB2123 sgabello | stool**  
faggio P02 faggio sbiancato / tessuto Plain SKU zafferano  
beech P02 bleached beechwood / Plain fabric SKU saffron yellow



**Clelia**  
**CB2120** sedia | *chairs*  
 faggio P02 faggio sbiancato /  
 tessuto Plain SKT limone  
*beech P02 bleached beechwood /*  
*Plain fabric SKT lemon yellow*  
 faggio P132 grafite / tessuto  
 Plain SKV rosa  
*beech P132 graphite /*  
*Plain fabric SKV pink*  
**CB2123** sgabello | *stool*  
 faggio P132 grafite / tessuto  
 Plain SKY bosco  
*beech P132 graphite / Plain fabric*  
*SKY forest green*  
**CB2122-A** sgabello | *stool*  
 faggio P02 faggio sbiancato /  
 multistrato faggio P02 faggio  
 sbiancato  
*beech P02 bleached beechwood /*  
*plywood beech P02 bleached*  
*beechwood*  
**CB2121** sgabello | *stool*  
 faggio P132 grafite / tessuto  
 Plain SKX timo  
*beech P132 graphite / Plain fabric*  
*SKX thyme green*  
**CB2124** sgabello | *stool*  
 faggio P02 faggio sbiancato /  
 tessuto Plain SKW bordeaux  
*beech P02 bleached beechwood /*  
*Plain fabric SKW burgundy*

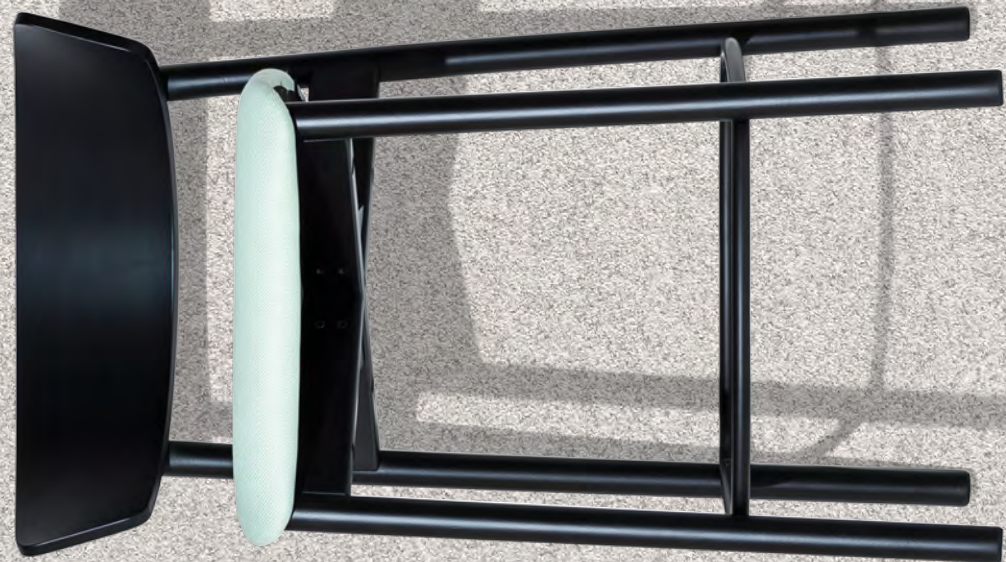

# Dee-J

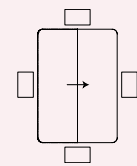
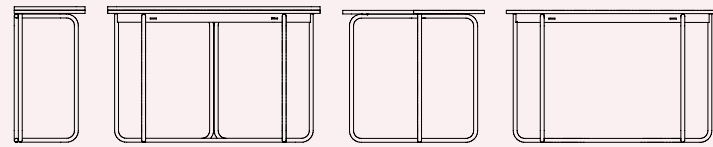

CB4808-RC 40 | 120x40(80) cm

## basamento base

metallo | *metal*



## piano top

nobilitato | *melamine*

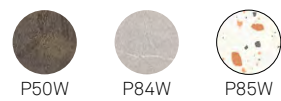

TAVOLO A CONSOLLE ALLUNGABILE - PIANO RADDOPPIABILE A LIBRO | *EXTENDIBLE  
CONSOLE TABLE - FOLDING TABLE TOP. DOUBLES IN LENGTH WHEN OPENED*

tavoli e consolle pieghevoli | *folding tables and consoles*

Dee-J CB4808-RC 40 consolle | *consoles*  
metallo P3L rosso ossido opaco / nobilitato P85W terrazzo  
*metal P3L matt oxide red / melamine P85W terrazzo*



Dee-J CB4808-RC 40 consolle | consoles  
metallo P94 bianco ottico opaco / nobilitato P84W pietra piacentina  
*metal P94 matt optic white / melamine P84W piacentina stone*  
metallo P15 nero opaco / nobilitato P50W bronzo ossido  
*metal P15 matt black / melamine P50W oxide bronze*  
metallo P3L rosso ossido opaco / nobilitato P85W terrazzo  
*metal P3L matt oxide red / melamine P85W terrazzo*



Dee-J CB4808-RC 40 consolle | *consoles*  
metallo P94 bianco ottico opaco / nobilitato P84W pietra piacentina  
*metal P94 matt optic white / melamine P84W piacentina stone*  
Signorina CB2111 sedia | *chair*  
metallo P6L bosco opaco / tessuto Plain SKY bosco  
*metal P6L matt forest green / Plain fabric SKY forest green*





# Dix

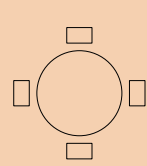
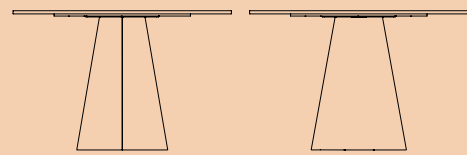

CB4804-FD 90 | Ø90 cm

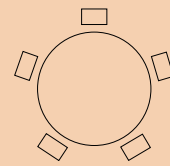

CB4804-FD 120 | Ø120 cm

tavoli fissi e allungabili | extending and non-extending tables

Dix CB4804-FD 120 tavolo fisso | *non-extending table*  
 metallo P3L rosso ossido opaco / nobilitato P85W terrazzo  
*metal P3L matt oxide red / melamine P85W terrazzo*

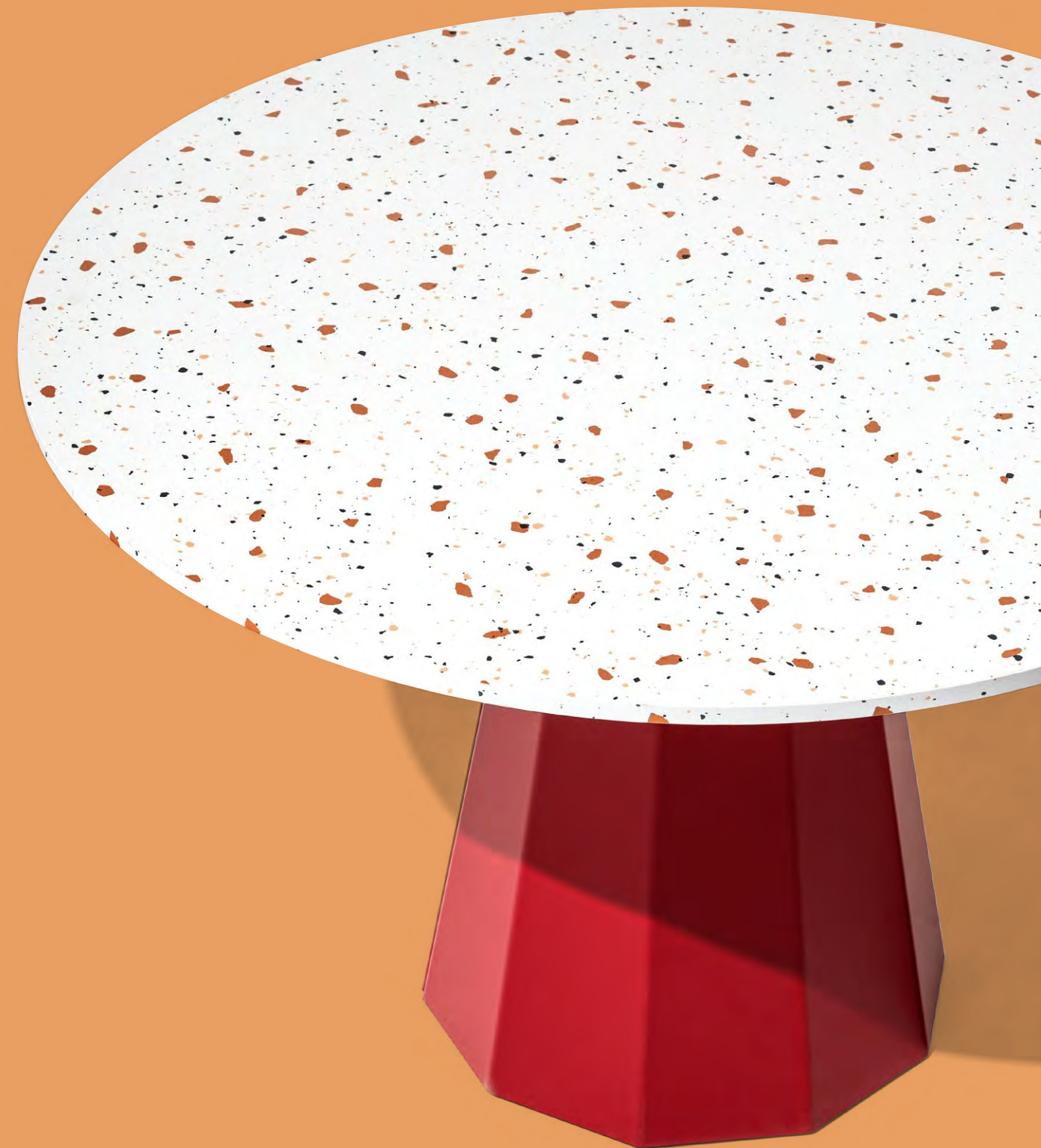

## basamento base

metallo | *metal*



## piano top

laccato | *lacquered*



nobilitato | *melamine*

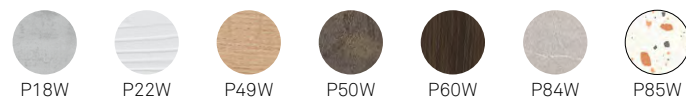

laminato | *laminated*

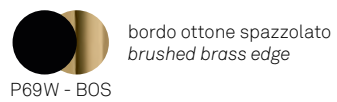

bordo ottone spazzolato  
*brushed brass edge*

laminato stratificato |  
*multilayer laminated*



bordo anima nera  
*edge black core*

Dix CB4804-FD 120 tavolo fisso | *non-extending table*  
 metallo P3L rosso ossido opaco / nobilitato P85W terrazzo  
*metal P3L matt oxide red / melamine P85W terrazzo*  
 metallo P15 nero opaco / nobilitato P84W pietra piacentina  
*metal P15 matt black / melamine P84W piacentina stone*  
 metallo P94 bianco ottico opaco / nobilitato P49W rovere naturale  
*metal P94 matt optic white / melamine P49W natural oak*  
 Yo! CB1988 sedia | *chair*  
 metallo P2L cipria opaco / tessuto Plain SKW bordeaux  
*metal P2L matt pink / Plain fabric SKW burgundy*



Dix CB4804-FD 120 tavolo fisso | *non-extending table*  
metallo P94 bianco ottico opaco / nobilitato P84W pietra piacentina  
*metal P94 matt optic white / melamine P84W piacentina stone*  
Signorina CB2111 sedia | *chair*  
metallo P94 bianco ottico opaco / tessuto Plain SKQ sabbia  
*metal P94 matt optic white / Plain fabric SKQ sand*  
Pof CB5207 pouf | *ottoman*  
tessuto Cros SLE rosa | *Cros fabric SLE pink*



# Ens

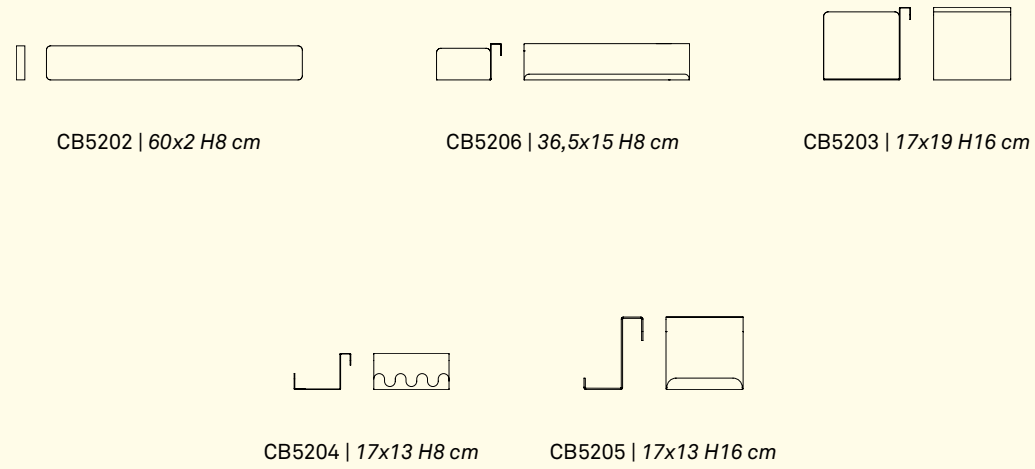

CB5202 | 60x2 H8 cm

CB5206 | 36,5x15 H8 cm

CB5203 | 17x19 H16 cm

CB5204 | 17x13 H8 cm

CB5205 | 17x13 H16 cm

## struttura frame

legno | wood



metallo | metal

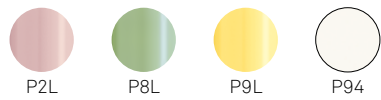

NOTA per le combinazioni disponibili consultare il listino prezzi. | NOTE please check all available combinations in the price list.

## mensole e altri accessori | shelves and other accessories



Ens mensola | shelves  
**CB5202** faggio P02 faggio sbiancato | beech P02 bleached beechwood  
**CB5204** metallo P94 bianco ottico opaco - P8L timo opaco  
 P94 matt optic white - P8L matt thyme green  
**CB5203** metallo P9L limone opaco | metal P9L matt lemon yellow  
**CB5205 - CB5206** metallo P2L cipria opaco | P2L matt pink



Ens mensole | shelves  
 CB5202 faggio P02 faggio sbiancato | beech P02 bleached beechwood  
 CB5203 metallo P9L limone opaco | metal P9L matt lemon yellow  
 CB5205 metallo P2L cipria opaco | metal P2L matt pink  
 CB5206 metallo P94 bianco ottico opaco | metal P94 matt optic white  
 CB5204 metallo P8L timo opaco | metal P8L matt thyme green

Ens mensole | shelves  
 CB5202 faggio P02 faggio sbiancato  
 beech P02 bleached beechwood  
 CB5204 metallo P8L timo opaco - P9L  
 limone opaco - P94 bianco ottico opaco  
 P8L matt thyme green - P9L matt lemon  
 yellow - P94 matt optic white  
 CB5205 metallo P94 bianco ottico  
 opaco - P2L cipria opaco  
 P94 matt optic white - P2L matt pink  
 CB5206 metallo P94 bianco ottico  
 opaco - P8L timo opaco  
 P94 matt optic white - P8L matt  
 thyme green  
 CB5203 metallo P9L limone opaco -  
 P94 bianco ottico opaco - P2L cipria opaco  
 metal P9L matt lemon yellow -  
 P94 matt optic white - P2L matt pink





# Iron

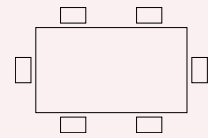
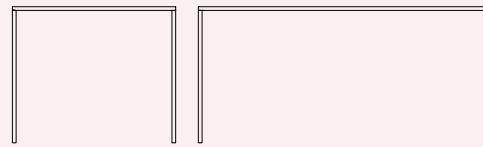

CB4809-FR 160 | 160x90 cm

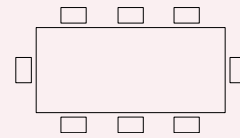

CB4809-FR 200 | 200x100 cm

## gambe legs

metallo | metal



## piano top

metallo | metal



NOTA per le combinazioni disponibili consultare il listino prezzi. | NOTE please check all available combinations in the price list.

## tavoli fissi e allungabili | extending and non-extending tables

Iron CB4809-FR 200 tavolo fisso | non-extending table  
metallo P15 nero opaco | metal P15 matt black



Iron tavoli fissi | *non-extending tables*  
CB4809-FR 200 metallo P15 nero opaco | *metal P15 matt black*  
CB4809-FR 160 metallo P94 bianco ottico opaco | *metal P94 matt optic white*





Iron

Iron CB4809-FR 160 tavolo fisso | *non-extending table*  
metallo P94 bianco ottico opaco | *metal P94 matt optic white*  
Tuka CB1993 sedia | *chair*  
metallo P3L rosso ossido opaco / tessuto Cros SLE rosa  
*metal P3L matt oxide red / Cros fabric SLE pink*

tavoli fissi e allungabili | *extending and non-extending tables*



# Libra

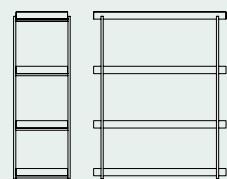

CB6102-1 | 90x38,5 H110,4 cm

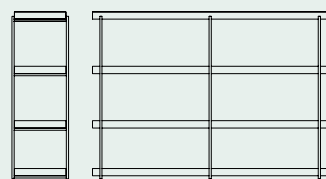

CB6102-2 | 162x38,5 H110,4 cm

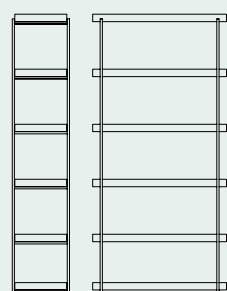

CB6102-3 | 90x38,5 H184,4 cm

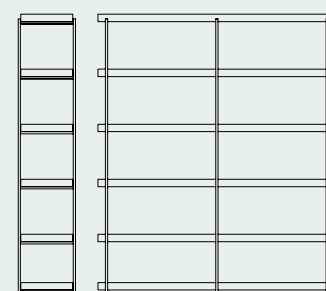

CB6102-4 | 162x38,5 H184,4 cm

## struttura frame

metallo | *metal*



## ripiani shelves

nobilitato | *melamine*

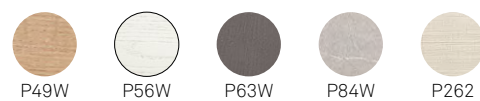

mobili | cabinets



Libra CB6102-3 mobili | cabinets  
metallo P94 bianco ottico opaco / nobilitato P56W bianco spazzolato  
metal P94 matt optic white / melamine P56W brushed white

Libra mobili | cabinets  
 CB6102-1 metallo P15 nero opaco / nobilitato P49W rovere naturale  
 metal P15 matt black / melamine P49W natural oak  
 CB6102-4 metallo P15 nero opaco / nobilitato P84W pietra piacentina  
 metal P15 matt black / melamine P84W piacentina stone  
 CB6102-2 metallo P94 bianco ottico opaco / nobilitato P262 bianco  
 naturale | P94 matt optic white / melamine P262 white





Libra mobili | cabinets  
CB6102-1 metallo P15 nero opaco / nobilitato P49W rovere naturale  
metal P15 matt black / melamine P49W natural oak

Libra mobili | cabinets  
CB6102-1 metallo P15 nero opaco / nobilitato P49W rovere naturale  
metal P15 matt black / melamine P49W natural oak



# Made

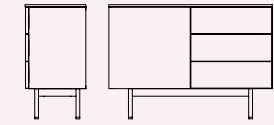

CB6101-1 | 108x40 H75,5 cm

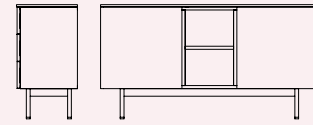

CB6101-2 | 144x40 H75,5 cm

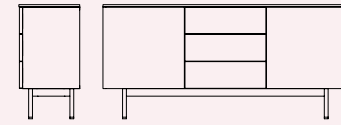

CB6101-3 | 162x40 H75,5 cm

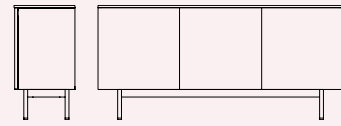

CB6101-4 | 162x40 H75,5 cm

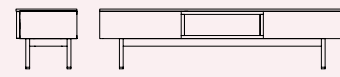

CB6101-5 | 162x40 H39,5 cm

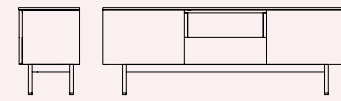

CB6101-6 | 162x40 H57,5 cm

## struttura frame

nobilitato | melamine



## ante/cassetti doors/drawers

laccato | lacquered



nobilitato | melamine



## base base

metallo | metal



NOTA per le combinazioni disponibili consultare il listino prezzi. | NOTE please check all available combinations in the price list.

mobili | cabinets



**Made** mobili | cabinets  
**CB6101-2** nobilitato P49W rovere naturale / nobilitato P23L cipria opaco / metallo P15 nero opaco  
 melamine P49W natural / melamine P23L pale pink / metal P15 matt black  
**CB6101-4** nobilitato P84W pietra piacentina / laccato P21L canapa opaco / metallo P15 nero opaco  
 melamine P84W piacentina stone / lacquered P21L matt hemp / metal P15 matt black

Made



connubia

mobili | cabinets

Made mobili | cabinets  
CB6101-2 nobilitato P262 bianco / laccato P35L arancio opaco / metallo  
P15 nero opaco | melamine P262 white / lacquered P35L matt orange/  
metal P15 matt black



Daily stories

**Made** mobili | cabinets

**CB6101-6** nobilitato P56W bianco spazzolato / nobilitato P49W rovere naturale / metallo P15 nero opaco  
*melamine P56W brushed white / melamine P49W natural / metal P15 matt black*

**CB6101-3** nobilitato P49W rovere naturale / laccato P24L bordeaux opaco / metallo P15 nero opaco  
*melamine P49W natural / lacquered P24L matt burgundy / metal P15 matt black*

**CB6101-1** nobilitato P63W cemento scuro / laccato P176 tortora opaco / metallo P15 nero opaco  
*melamine P63W Dark cement / lacquered P176 taupe / metal P15 matt black*

**CB6101-5** nobilitato P262 bianco / laccato P36L salvia opaco / metallo P15 nero opaco  
*melamine P262 white / lacquered P36L Thyme / metal P15 matt black*



# Mirò

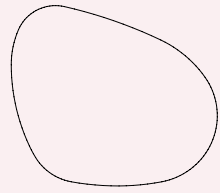

CB5213-P | 70x2 H79,5 cm

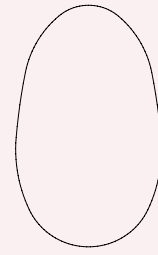

CB5213-G | 64x2 H106,5 cm

## struttura frame

specchio | *mirror*



GMR

## decoro decor

serigrafia | *screen print*



P3L



P7L

## specchi | mirrors

**Mirò** CB5213-G specchio | *mirror*  
specchio GMR - serigrafia P3L  
rosso ossido opaco  
*mirror GMR - screen print P3L*  
*matt oxide red*  
**Yo!** CB5210 panca | bench  
faggio P02 faggio sbiancato -  
metallo P9L limone opaco /  
tessuto Plain SKT limone  
*beech P02 bleached beechwood -*  
*metal P9L lemon yellow /*  
*Plain fabric SKT lemon yellow*  
**App** CB5212 appendiabiti |  
*coat stands / hangers*  
faggio P02 faggio sbiancato /  
metallo P9L limone opaco  
*beech P02 bleached beechwood /*  
*metal P9L matt lemon yellow*







Mirò CB5213-P specchi | mirrors  
specchio GMR - serigrafia P3L rosso ossido opaco  
mirror GMR - screen print P3L matt oxide red



# Pof

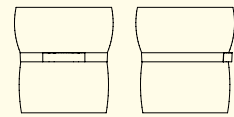

CB5207 | Ø47 H48 cm

## struttura/sedile frame/seat

tessuto | fabric



SLC



SLD



SLE

Cros



CINGHIA DECORATIVA IN GOMMA EVA (ETILENE VINIL ACETATO) COLORE CANAPA - PIEDINI IN NYLON |  
HEMP COLOR EVA (ETHYLENE VINYL ACETATE) DECORATIVE STRAP - NYLON FEET

pouf | ottoman



Pof CB5207 pouf | ottoman  
tessuto Cros SLC limone  
Cros fabric SLC lemon yellow

**Pof** CB5207 pouf | ottoman  
tessuto Cros SLC limone -  
SLD zafferano - SLE rosa  
Cros fabric SLC lemon yellow -  
SLD saffron yellow - SLE pink  
**Tapi** CB7224 tappeto | rug  
polipropilene/poliestere  
tonalità beige/giallo/arancio/rosa  
polypropylene/polyester  
shades of beige/orange/yellow/pink

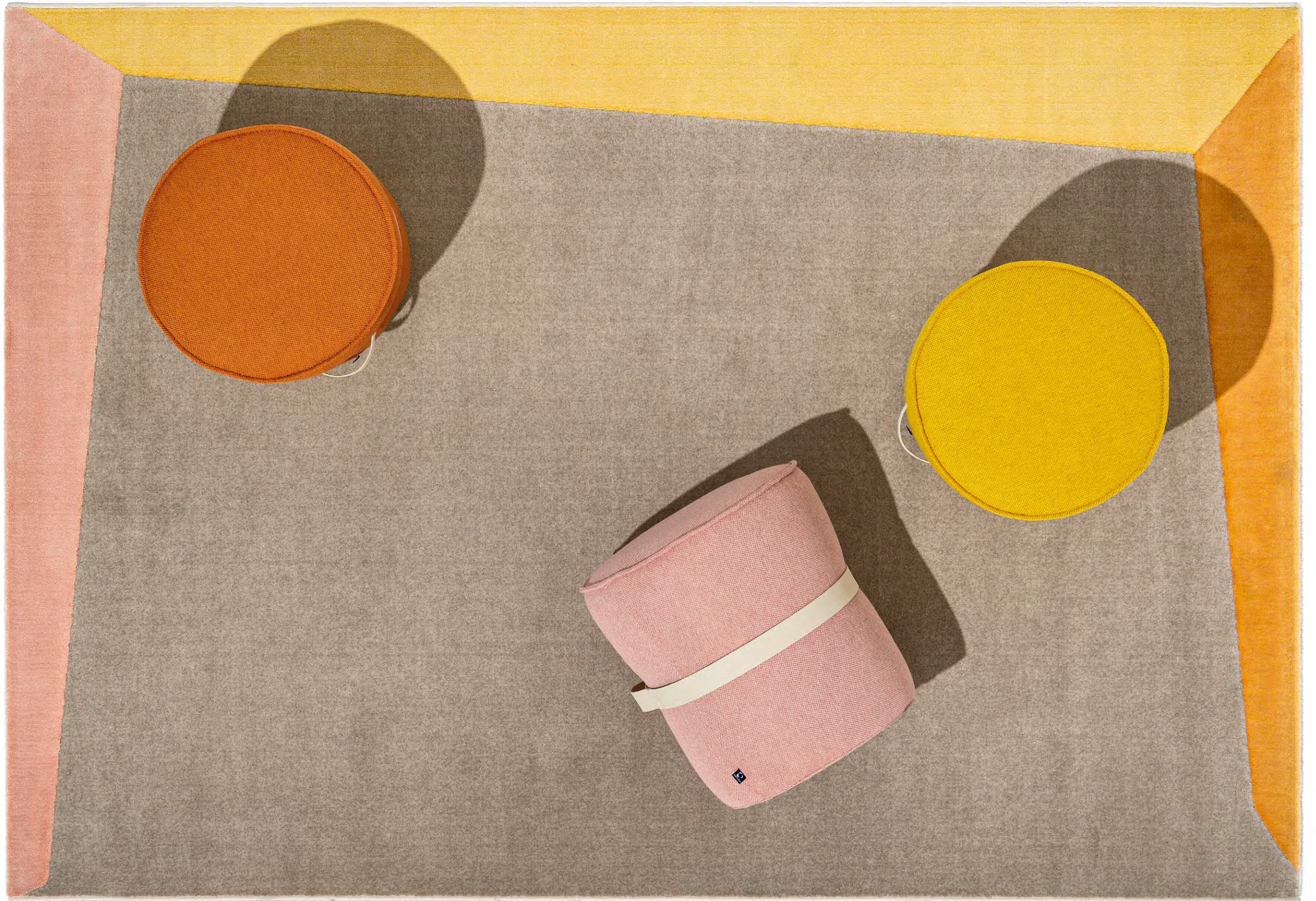



**Pof CB5207 pouf | ottoman**  
tessuto Cros SLE rosa  
Cros fabric SLE pink



**Pof CB5207 pouf | ottoman**  
tessuto Cros SLC limone - SLD zafferano - SLE rosa  
Cros fabric SLC lemon yellow - SLD saffron yellow - SLE pink

# Quadro

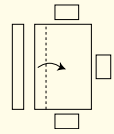
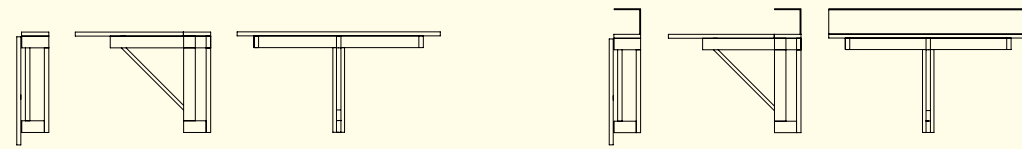

CB08 | 90x14(60) H50 cm

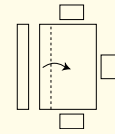

CB08-A | 90x14,5(60) H62 cm

## struttura frame

laccato | lacquered



## piano top

nobilitato | melamine



## alzatina shelf

metallo | metal

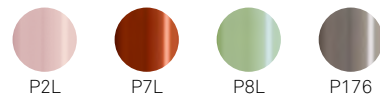

TAVOLO PIEGHEVOLE QUADRO CB08 DOTATO DI MENSOLA SUPERIORE IN LAMIERA CURVATA |  
CB08 QUADRO FOLDING TABLE WITH AN UPPER SHELF MADE WITH A CURVED METAL SHEET

NOTA per le combinazioni disponibili consultare il listino prezzi. | NOTE please check all available combinations in the price list.



**Quadro CB08-A** tavolo pieghevole | folding table  
laccato P94 bianco ottico opaco / nobilitato P94 bianco ottico opaco /  
metallo P7L zafferano opaco | lacquered P94 matt optic white / melamine  
P94 matt optic white / metal P7L matt saffron yellow  
**Clelia** CB2123 sgabello | stool  
faggio P02 faggio sbiancato / tessuto Plain SKU zafferano  
beech P02 bleached beechwood / Plain fabric SKU saffron yellow



Quadro CB08-A tavolo pieghevole | *folding table*  
 laccato P94 bianco ottico opaco / nobilitato P94 bianco  
 ottico opaco / metallo P7L zafferano opaco  
 lacquered P94 matt optic white / melamine P94 matt  
 optic white / metal P7L matt saffron yellow

Quadro CB08-A tavolo pieghevole | *folding table*  
 laccato P94 bianco ottico opaco / nobilitato P94 bianco ottico opaco /  
 metallo P7L zafferano opaco - P8L timo opaco - P2L cipria opaco  
 lacquered P94 matt optic white / melamine P94 matt optic white /  
 metal P7L matt saffron yellow - P8L matt thyme green - P2L matt pink

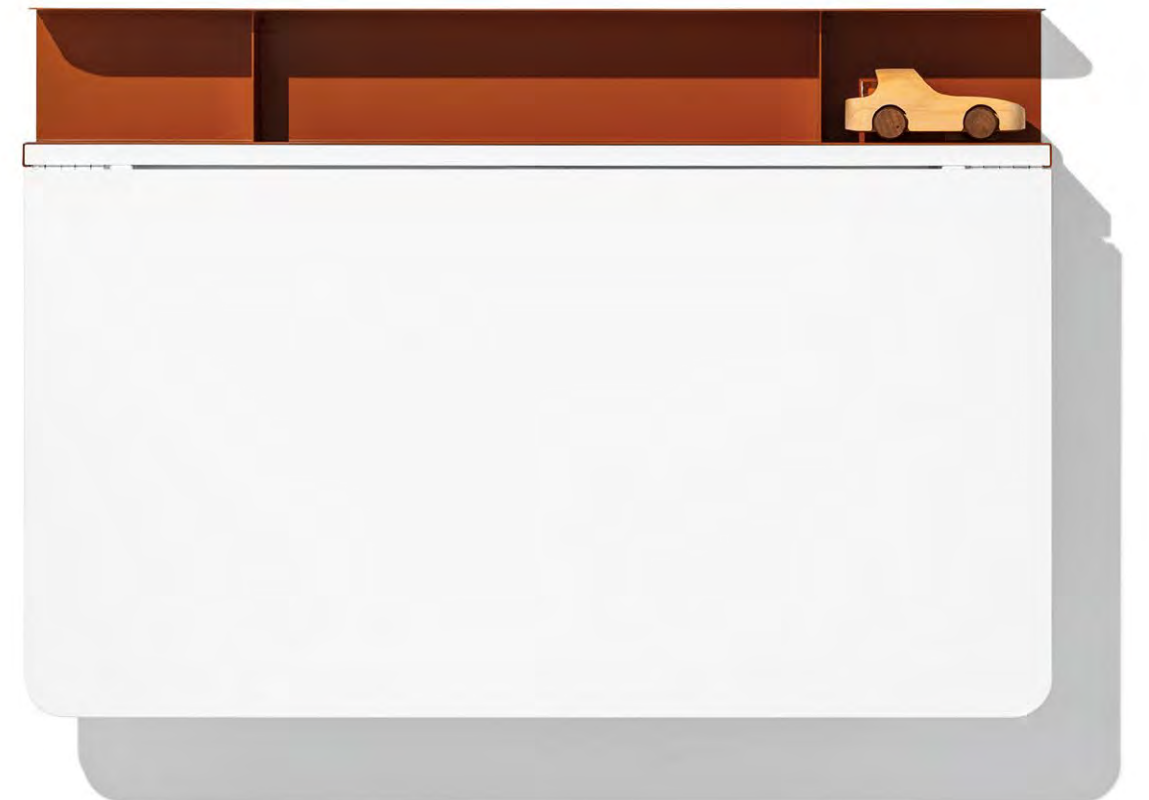

# Riley

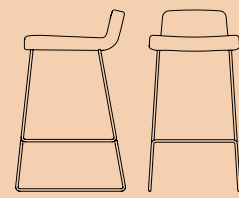

CB2108  
41x48,5 H80 HS65 cm

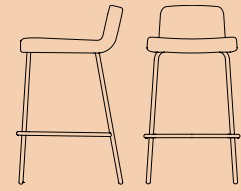

CB2110  
43x47,5 H80 HS65 cm

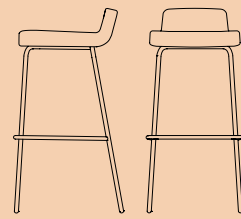

CB2116  
43x48,5 H91 HS75 cm

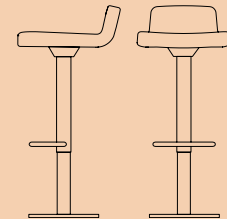

CB2109  
38x46 H91,5(76,5) HS81(65) cm

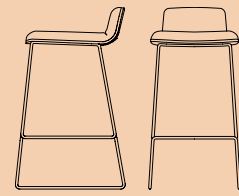

CB2108-A  
41x48,5 H80 HS66 cm

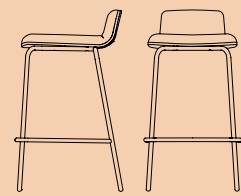

CB2110-A  
43x47,5 H80 HS66 cm

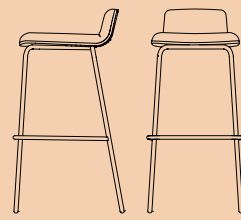

CB2116-A  
43x48,5 H91 HS76 cm

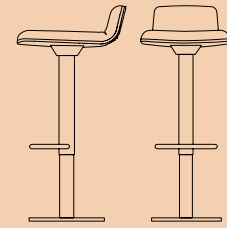

CB2109-A  
38x46 H91,5(76,5) HS82(66) cm

## struttura frame

metallo | metal



## sedile seat

legno | wood



tessuto | fabric



similpelle | faux leather



rig. cuoio | reg. leather

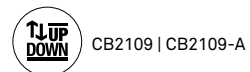
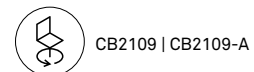
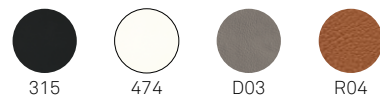

NOTA per le combinazioni disponibili consultare il listino prezzi. | NOTE please check all available combinations in the price list.



Riley Soft CB2108-A sgabello | stool  
metallo P7L zafferano opaco / tessuto Cros SLD zafferano  
metal P7L matt saffron yellow / Cros fabric SLD saffron yellow

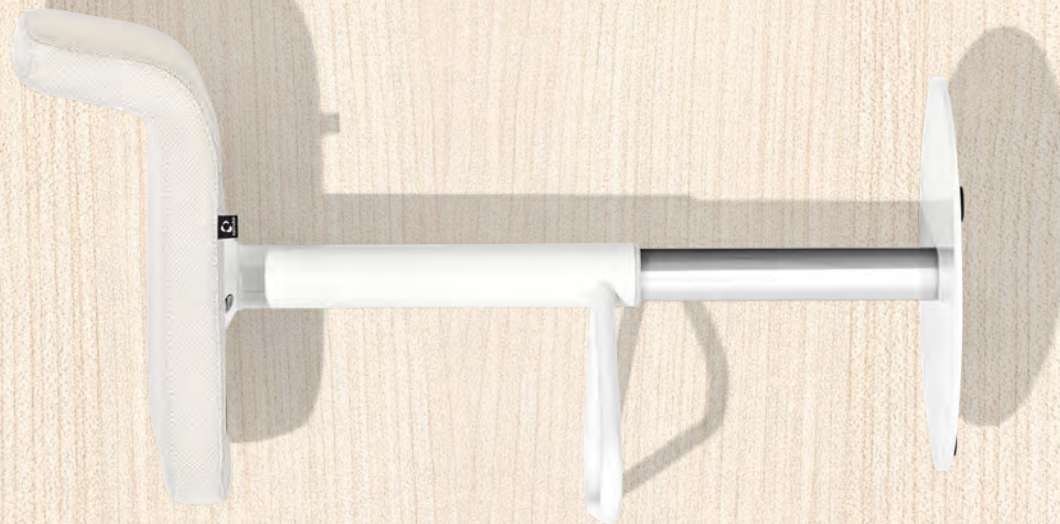
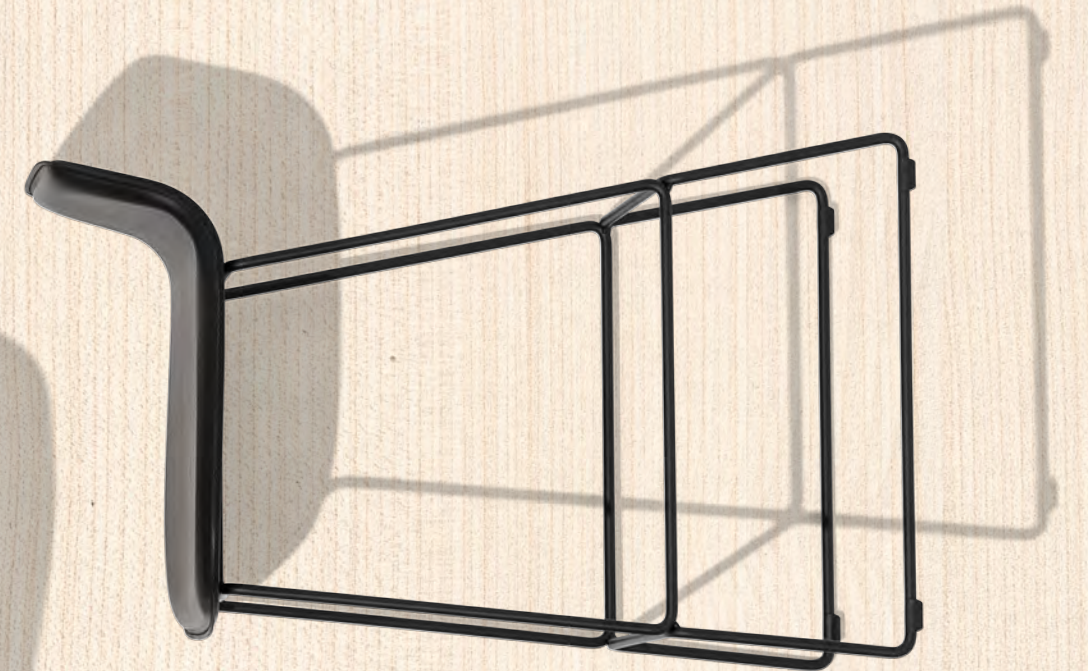
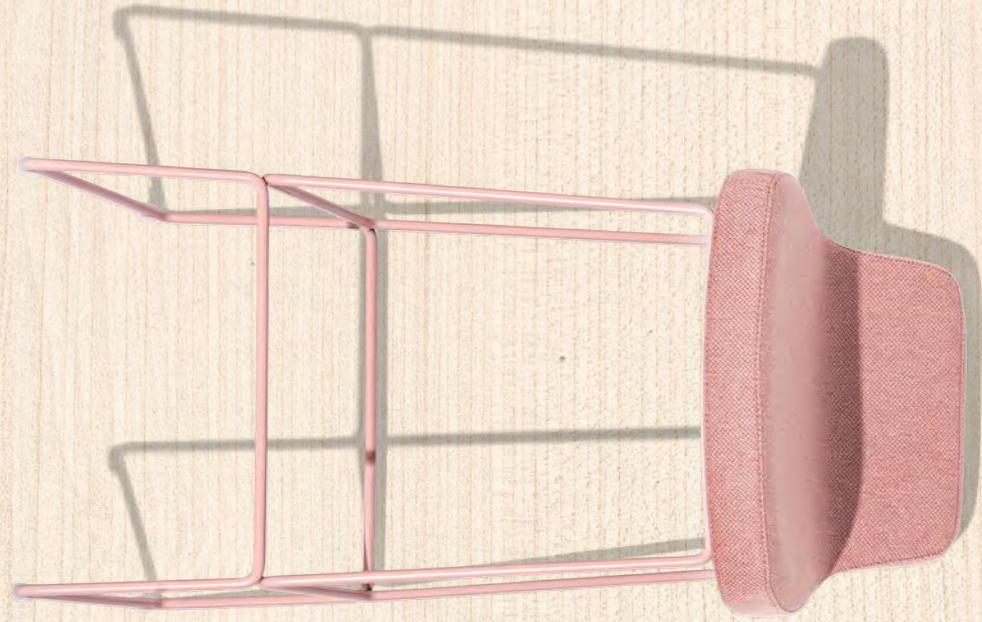

**Riley**  
 sgabelli in metallo | metal stools  
**CB2108-A** P7L zafferano opaco /  
 tessuto Cros SLD zafferano  
 P7L matt saffron yellow /  
 Cros fabric SLD saffron yellow  
 P9L limone opaco /  
 tessuto Cros SLC limone  
 P9L matt lemon yellow /  
 Cros fabric SLC lemon yellow  
**CB2108** P2L cipria opaco /  
 tessuto Cros SLE rosa  
 P2L matt pink / Cros fabric SLE pink  
 P15 nero opaco / rigenerato  
 di cuoio 315 nero  
 P15 matt black / regenerated  
 leather 315 black  
**CB2109** P94 bianco ottico opaco /  
 tessuto Cros SKZ sabbia  
 P94 matt optic white /  
 Cros fabric SKZ sand  
**CB2116** P15 nero opaco / multistrato  
 faggio P02 faggio sbiancato  
 P15 matt black / plywood beech P02  
 bleached beechwood



Riley CB2108-A - CB2108  
sgabelli in metallo | metal stools  
P2L cipria opaco / tessuto Cros SLE rosa  
P2L matt pink / Cros fabric SLE pink



Riley sgabelli in metallo | metal stools  
CB2108 P15 nero opaco / rigenerato di cuoio 315 nero  
P15 matt black / regenerated leather 315 black  
CB2110 P15 nero opaco / similpelle Ekos G8N nero  
P15 matt black / Ekos faux leather G8N black  
CB2116 P15 nero opaco / multistrato faggio P02 faggio sbiancato  
P15 matt black / plywood beech P02 bleached beechwood



## Riley sgabelli in metallo | metal stools

CB2108 P8L timo opaco / tessuto Cros SLG timo

P8L matt thyme green / Cros fabric SLG thyme green

P2L cipria opaco / tessuto Cros SLE rosa

P2L matt pink / Cros fabric SLE pink

CB2108-A P7L zafferano opaco / tessuto Cros SLD zafferano

P7L matt saffron yellow / Cros fabric SLD saffron yellow

P9L limone opaco / tessuto Cros SLC limone

P9L matt lemon yellow / Cros fabric SLC lemon yellow

CB2109 P94 bianco ottico opaco / tessuto Cros SKZ sabbia

P94 matt optic white / Cros fabric SKZ sand



# Sibilla Soft

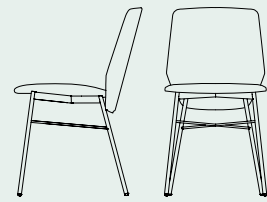

CB1959-A | 45x56 H83 cm

## struttura frame

metallo | metal



## sedile seat

tessuto | fabric



similpelle | faux leather



sedie e sgabelli | chairs and stools



Sibilla Soft CB1959-A sedia | chair  
metallo P7L zafferano opaco / tessuto Cros SLD zafferano  
metal P7L matt saffron yellow / Cros fabric SLD saffron yellow



**Sibilla Soft** CB1959-A sedia | chair  
 metallo P6L bosco opaco / tessuto Cros SLH bosco  
 metal P6L matt forest green / Cros fabric SLH forest green



**Sibilla Soft** CB1959-A  
 sedia in metallo | metal chair  
 P3L rosso ossido opaco / tessuto Cros SLF bordeaux  
 P3L matt oxide red / Cros fabric SLF burgundy  
 P7L zafferano opaco / tessuto Cros SLD zafferano  
 P7L matt saffron yellow / Cros fabric SLD saffron yellow  
 P176 tortora opaco / similpelle Ekos G8Q tortora  
 P176 matt taupe / Ekos faux leather G8Q taupe  
 P6L bosco opaco / tessuto Cros SLH bosco  
 P6L matt forest green / Cros fabric SLH forest green  
 P94 bianco ottico opaco / tessuto Cros SKZ sabbia  
 P94 matt optic white / Cros fabric SKZ sand



**Sibilla Soft** CB1959-A sedia in metallo | *metal chair*  
 P6L bosco opaco / tessuto Cros SLH bosco  
 P6L matt forest green / *Cros fabric SLH forest green*  
 P3L rosso ossido opaco / tessuto Cros SLF bordeaux  
 P3L matt oxide red / *Cros fabric SLF burgundy*  
 P7L zafferano opaco / tessuto Cros SLD zafferano  
 P7L matt saffron yellow / *Cros fabric SLD saffron yellow*  
 P94 bianco ottico opaco / tessuto Cros SKZ sabbia  
 P94 matt optic white / *Cros fabric SKZ sand*  
 P176 tortora opaco / similpelle Ekos G8Q tortora  
 P176 matt taupe / *Ekos faux leather G8Q taupe*



# Signorina

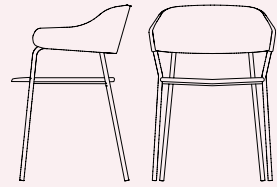

CB2111 | 56x53 H77 HB62 cm

## struttura frame

metallo | *metal*



## sedile seat

tessuto | *fabric*

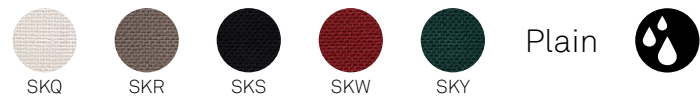

similpelle | *faux leather*



sedie e sgabelli | chairs and stools



Signorina CB2111 sedia | *chair*  
metallo P3L rosso ossido opaco / tessuto Plain SKW bordeaux  
*metal P3L matt oxide red / Plain fabric SKW burgundy*

NOTA per le combinazioni disponibili consultare il listino prezzi. | *NOTE please check all available combinations in the price list.*

Signorina

Signorina CB2111 sedia in metallo | metal chair  
metallo P15 nero opaco / similpelle Vintage S0W cenere  
metal P15 matt black / Vintage faux leather S0W ash grey  
P94 bianco ottico opaco / tessuto Plain SKQ sabbia  
P94 matt optic white / Plain fabric SKQ sand  
P6L bosco opaco / tessuto Plain SKY bosco  
P6L matt forest green / Plain fabric SKY forest green  
P3L rosso ossido opaco / tessuto Plain SKW bordeaux  
P3L matt oxide red / Plain fabric SKW burgundy  
P15 nero opaco / similpelle Vintage S0B tabacco  
P15 matt black / Vintage faux leather S0B tobacco



sedie e sgabelli | chairs and stools

Signorina



Signorina CB2111 sedia | chair  
metallo P15 nero opaco / similpelle Vintage S0W cenere  
metal P15 matt black / Vintage faux leather S0W ash grey

sedie e sgabelli | chairs and stools

Signorina CB2111  
sedia in metallo | metal chair  
P15 nero opaco /  
similpelle Vintage S0C ebano  
P15 matt black /  
Vintage faux leather S0C ebony  
P94 bianco ottico opaco /  
tessuto Plain SKQ sabbia  
P94 matt optic white /  
Plain fabric SKQ sand





# Stulle

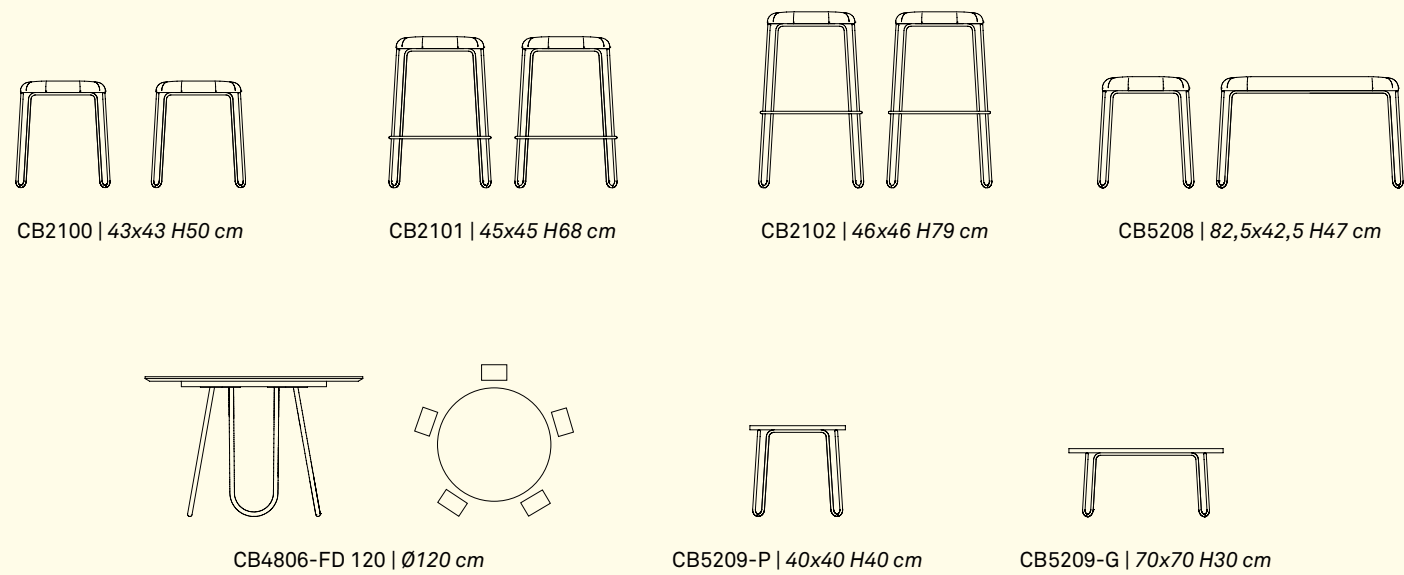

collezione | collection



## struttura frame

metallo | metal



## sedile seat

tessuto | fabric



similpelle | faux leather



## piano top

nobilitato | melamine

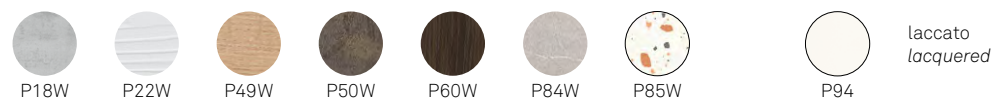

laminato | laminate



**Stulle CB2102 sgabello | stool**  
 metallo P9L limone opaco / tessuto Cros SLC limone  
 metal P9L matt lemon yellow / Cros fabric SLC lemon yellow

NOTA per le combinazioni disponibili consultare il listino prezzi. | NOTE please check all available combinations in the price list.

**Stulle** sgabelli in metallo | *metal stools*

**CB2101** P8L timo opaco / tessuto Cros SLH bosco  
 P8L matt thyme green / Cros fabric SLH forest green  
 P2L cipria opaco / tessuto Cros SLE rosa  
 P2L matt pink / Cros fabric SLE pink  
**CB2100** P15 nero opaco / tessuto Cros SLF bordeaux  
 P15 matt black / Cros fabric SLF burgundy

**CB2102** P8L timo opaco / tessuto Cros SLG timo  
 P8L matt thyme green / Cros fabric SLG thyme green  
 P9L limone opaco / tessuto Cros SLC limone  
 P9L matt lemon yellow / Cros fabric SLC lemon yellow  
 panca in metallo | *metal bench*  
**CB5208** P9L limone opaco / tessuto Cros SLC limone  
 P9L matt lemon yellow / Cros fabric SLC lemon yellow



**Stulle CB2101 sgabello | stool**  
metallo P2L cipria opaco / tessuto Cros SLE rosa  
metal P2L matt pink / Cros fabric SLE pink

**Stulle CB2102 sgabello | stool**  
metallo P8L timo opaco / tessuto Cros SLG timo  
P8L metal matt thyme green / Cros fabric SLG thyme green







**Stulle** CB5209-P tavolino fisso | *coffee table*  
metallo P7L zafferano opaco / nobilitato P60W termocotto  
metal P7L matt saffron yellow / melamine P60W termocotto

**Stulle** tavolini fissi | *coffee tables*  
CB5209-P metallo P15 nero opaco / nobilitato P84W pietra piacentina  
metal P15 matt black / melamine P84W piacentina stone  
CB5209-G metallo P2L cipria opaco / nobilitato P49W rovere naturale  
metal P2L matt pink / melamine P49W natural oak



**Stulle Table** CB4806-FD 120 tavolo | table  
metallo P94 bianco ottico opaco / nobilitato P84W pietra piacentina  
*metal P94 matt optic white / melamine P84W piacentina stone*  
**Sibilla** CB1959-A sedia | chair  
metallo P94 bianco ottico opaco / tessuto Cros SKZ sabbia  
*metal P94 matt optic white / Cros fabric SKZ sand*



**Stulle**

sgabelli in metallo | *metal stools*  
**CB2102** P8L timo opaco / tessuto Cros SLG timo  
*P8L matt thyme green / Cros fabric SLG thyme green*  
**CB2101** P2L cipria opaco / tessuto Cros SLE rosa  
*P2L matt pink / Cros fabric SLE pink*  
**CB2100** P15 nero opaco / tessuto Cros SLF bordeaux  
*P15 matt black / Cros fabric SLF burgundy*  
 panca in metallo | *metal bench*  
**CB5208** P9L limone opaco / tessuto Cros SLC limone  
*P9L limone opaco / tessuto Cros SLC limone*

tavolo in metallo | *metal table*  
**CB4806-FD 120** P3L rosso ossido opaco /  
 nobilitato P84W pietra piacentina  
*P3L matt oxide red / melamine P84W piacentina stone*  
 tavolini fissi in metallo | *metal coffee tables*  
**CB5209-P** P7L zafferano opaco /  
 nobilitato P49W rovere naturale  
*P7L matt saffron yellow / melamine P49W natural oak*  
**CB5209-G** metallo P2L cipria opaco /  
 nobilitato P60W termocotto  
*metal P2L matt pink / melamine P60W termocotto*



# Tabla

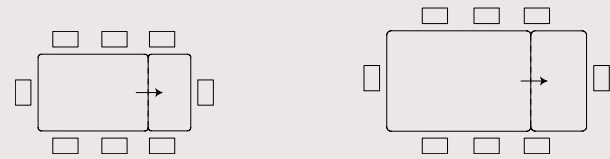
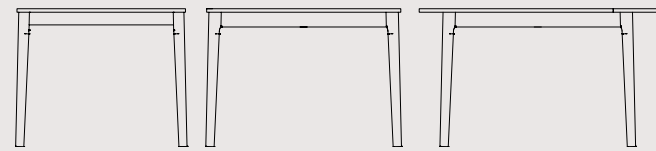

CB4803-R 130 | 132(182)x92 cm

CB4803-R 160 | 162(212)x92 cm

## gambe legs

legno | wood

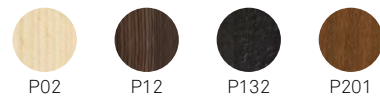

## cassonetto frame

metallo | metal



## piano top

nobilitato | melamine

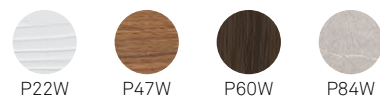

ALLUNGA MANUALE tavolo allungabile con meccanismo manuale; le allunghe vengono sollevate e posizionate all'altezza del piano principale.  
 MANUAL EXTENSION extendable table with manual mechanism; the extensions are manually lifted and aligned with the top.

NOTA per le combinazioni disponibili consultare il listino prezzi. | NOTE please check all available combinations in the price list.

## tavoli fissi e allungabili | extending and non-extending tables

**Tabla CB4803-R**  
 tavolo allungabile | extending table  
 faggio P02 faggio sbiancato /  
 nobilitato P84W pietra piacentina  
 beech P02 bleached beechwood /  
 melamine P84W piacentina stone





**Tabla** CB4803-R  
 tavolo allungabile | *extending table*  
 faggio P02 faggio sbiancato /  
 nobilitato P84W pietra piacentina  
*bleach P02 bleached beechwood /*  
*melamine P84W piacentina stone*  
**Clelia** CB2120-A sedie | *chairs*  
 faggio P02 faggio sbiancato /  
 multistrato faggio P02 faggio sbiancato  
*bleach P02 bleached beechwood /*  
*plywood beech P02 bleached beechwood*





Tabla CB4803-R tavolo allungabile | *extending table*  
faggio P132 grafite / nobilitato P60W termocotto  
beech P132 graphite / melamine P60W termocotto

Tabla CB4803-R tavolo allungabile | *extending table*  
faggio P132 grafite / nobilitato P60W termocotto  
beech P132 graphite / melamine P60W termocotto  
Tuka CB1993 sedia | *chair*  
metallo P7L zafferano opaco / tessuto Mat SLM zafferano  
metal P7L matt saffron yellow / Mat fabric SLM saffron yellow



## Tapi

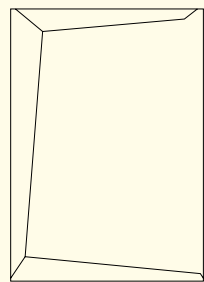

CB7224-A | 160x240 cm

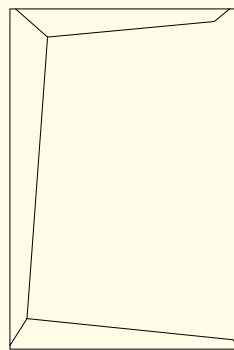

CB7224-B | 200x300 cm

### struttura frame

polipropilene/poliestere |  
polypropylene/polyester



TONALITÀ BEIGE/GIALLO/ARANCIO/ROSA  
SHADES OF BEIGE/ORANGE/YELLOW/PINK



TONALITÀ BEIGE  
SHADES OF BEIGE

TAPPETO TESSUTO A MACCHINA - 60% POLIPROPILENE 40% POLIESTERE |  
MACHINE MADE WOVEN RUG - 60% POLYPROPYLENE 40% POLYESTER

## tappeti | rugs



Tapi CB7224 tappeto | rug  
polipropilene/poliestere tonalità beige/giallo/arancio/rosa  
polypropylene/polyester shades of beige/orange/yellow/pink  
Pof CB5207 pouf | ottoman  
tessuto Cros SLC limone - SLE rosa  
Cros fabric SLC lemon yellow - SLE pink

**Tapi CB7224** tappeto | rug  
 polipropilene/poliestere  
 tonalità beige/giallo/arancio/rosa  
 polypropylene/polyester  
 shades of beige/orange/yellow/pink  
 polipropilene/poliestere tonalità beige  
 polypropylene/polyester shades of beige  
**Tuka CB2113** sedia lounge | lounge chair  
 faggio P132 grafite / tessuto Cros SLB nero  
 beech P132 graphite / Cros fabric SLB black



# Tria

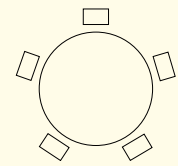
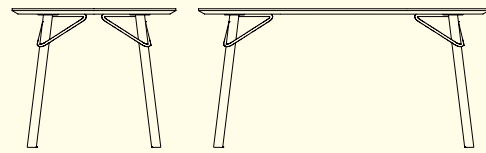

CB4807-FD 120 | Ø 120 cm

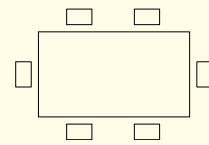

CB4807-FR 160 | 160x90 cm

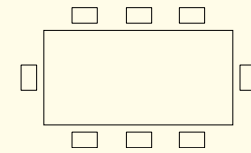

CB4807-FR 200 | 200x100 cm

## gambe/piano legs/top

legno | wood



## angolari angles

metallo | metal

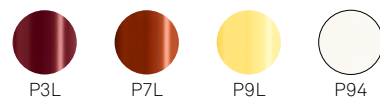

tavoli fissi e allungabili | extending and non-extending tables



Tria CB4807-FR 200 tavolo fisso | non-extending table  
faggio P02 faggio sbiancato / metallo P9L limone opaco  
beech P02 bleached beechwood / metal P9L matt lemon yellow

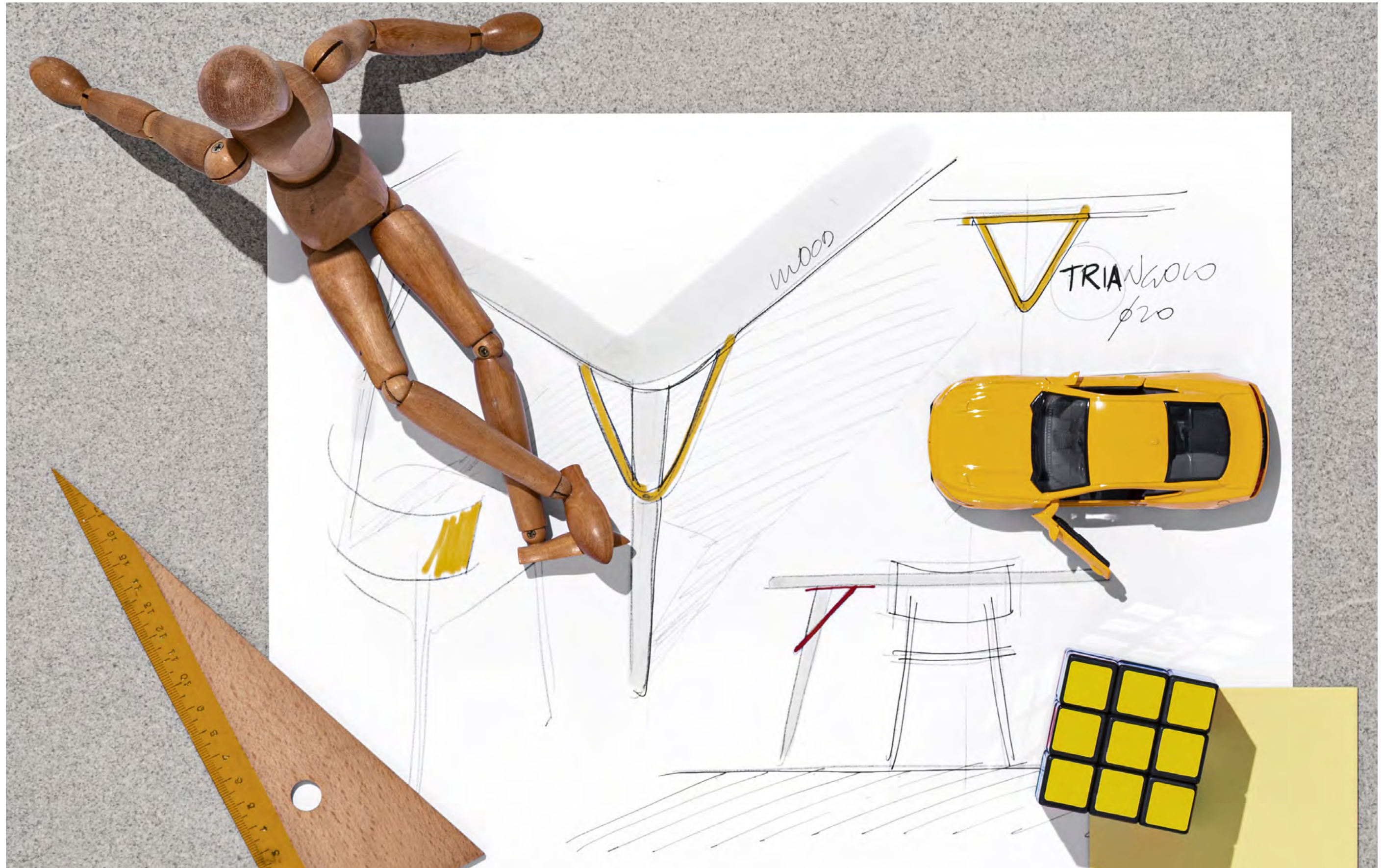

Tria tavoli fissi | *non-extending tables*  
CB4807-FR 200 faggio P02 faggio sbiancato / metallo P9L limone opaco  
*beech P02 bleached beechwood / metal P9L matt lemon yellow*  
CB4807-FR 160 faggio P132 grafite / metallo P7L zafferano opaco  
*beech P132 graphite / metal P7L matt saffron yellow*  
CB4807-FD 120 faggio P02 faggio sbiancato / metallo P94 bianco ottico opaco  
*beech P02 bleached beechwood / metal P94 matt optic white*





Tria CB4807-FR 160 tavolo fisso | *non-extending table*  
faggio P132 grafite / metallo P3L rosso ossido opaco  
beech P132 graphite / P3L matt oxide red

Tria CB4807-FR 160 tavolo fisso | *non-extending table*  
faggio P132 grafite / metallo P3L rosso ossido opaco  
beech P132 graphite / P3L matt oxide red  
Sibilla Soft CB1959-A sedia | *chair*  
metallo P3L rosso ossido opaco / tessuto Cros SLF bordeaux  
metal P3L matt oxide red / Cros fabric SLF burgundy





Tria

tavoli fissi e allungabili | extending and non-extending tables

**Tria** CB4807-FD 120  
tavolo fisso | *non-extending table*  
faggio P02 faggio sbiancato /  
metallo P94 bianco ottico opaco  
*beech P02 bleached beechwood /*  
*metal P94 matt optic white*  
**Tuka** CB1994 sedia | *chair*  
faggio P02 faggio sbiancato /  
tessuto Cros SKZ sabbia  
*beech P02 bleached beechwood /*  
*Cros fabric SKZ sand*  
**Pof** CB5207 pouf | *ottoman*  
tessuto Cros SLC limone  
*Cros fabric SLC lemon yellow*  
**App** CB5212  
appendiabiti | *coat stands / hangers*  
faggio P02 faggio sbiancato /  
metallo P94 bianco ottico opaco  
*beech P02 bleached beechwood /*  
*metal P94 matt optic white*



# Tuka

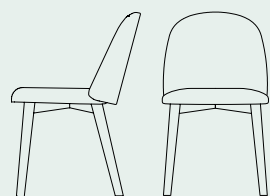

CB1994 | 46x57 H81 cm

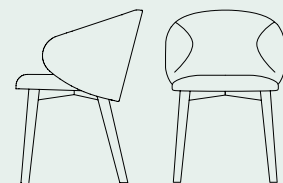

CB2117 | 55x56 H76 HB65 cm

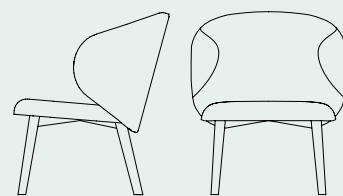

CB2113 | 69x67 H80 cm

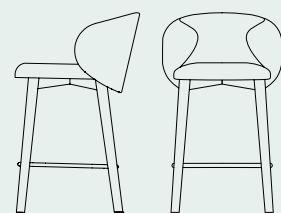

CB1997 | 55x56 H88 HS65 cm

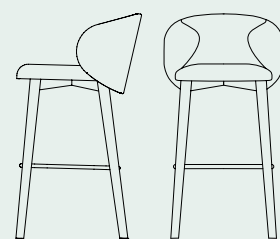

CB1998 | 55x56 H98 HS76 cm

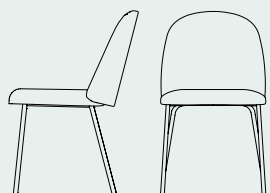

CB1993 | 46x57 H81 cm

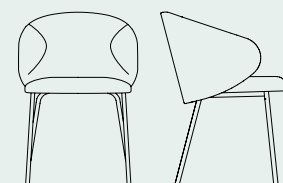

CB1999 | 55x56 H76 HB65 cm

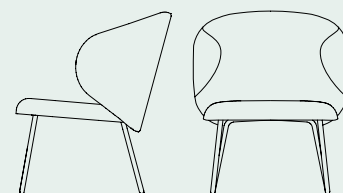

CB2114 | 69x67 H80 cm

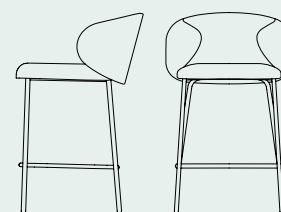

CB1995 | 55x56 H88 HS65 cm

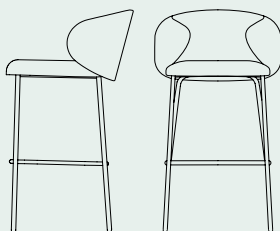

CB1996 | 55x56 H98 HS76 cm



**Tuka** sedie | chairs  
**CB1993** metallo P7L zafferano opaco / tessuto Mat SLM zafferano  
 metal P7L matt saffron yellow / Mat fabric SLM saffron yellow  
**CB2117** faggio P132 grafite / tessuto Cros SLG timo  
 beech P132 graphite / Cros fabric SLG thyme green

NOTA per le combinazioni disponibili consultare il listino prezzi. | NOTE please check all available combinations in the price list.

**struttura**  
*frame*

legno | *wood*

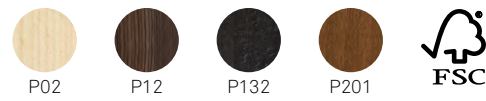

metallo | *metal*



**sedile**  
*seat*

tessuto | *fabric*



similpelle | *faux leather*



CB1997 | CB1998 SGABELLI CON POGGIAPIEDI IN METALLO VERNICIATO NERO OPACO |  
STOOLS WITH MATT BLACK VARNISHED METAL FOOTREST

NOTA per le combinazioni disponibili consultare il listino prezzi. | NOTE please check all available combinations in the price list.



Tuka CB2114 sedia lounge | lounge chair  
metallo P94 bianco ottico opaco / tessuto Mat SLN rosa  
metal P94 matt optic white / Mat fabric SLN pink



Tuka CB1997 sgabello | stool  
faggio P132 grafite / tessuto Mat SLK cammello  
beech P132 graphite / Mat fabric SLK camel brown

Tuka sgabelli in metallo | metal stools  
CB1995 P6L bosco opaco / tessuto Cros SLH bosco  
P6L matt forest green / Cros fabric SLH forest green  
CB1996 P15 nero opaco / tessuto Mat SLK cammello  
P15 matt black / Mat fabric SLK camel brown



Tuka

**Tuka**  
 sgabelli | stools  
**CB1997** faggio P132 grafite /  
 tessuto Mat SLK cammello  
*beech P132 graphite /  
 Mat fabric SLK camel brown*  
**CB1996** metallo P15 nero opaco /  
 tessuto Mat SLQ grigio  
*metal P15 matt black /  
 Mat fabric SLQ grey*  
 sedie lounge | lounge chairs  
**CB2113** faggio P132 grafite /  
 tessuto Cros SLB nero  
*beech P132 graphite /  
 Cros fabric SLB black*  
**CB2114** metallo P94 bianco ottico  
 opaco / tessuto Mat SLN rosa  
*metal P94 matt optic white /  
 Mat fabric SLN pink*  
 sedie | chairs  
**CB1993** metallo P7L zafferano opaco /  
 tessuto Mat SLM zafferano  
*metal P7L matt saffron yellow /  
 Mat fabric SLM saffron yellow*  
**CB1999** metallo P6L bosco opaco /  
 tessuto Cros SLG timo  
*metal P6L matt forest green /  
 Cros fabric SLG thyme green*  
**CB1994** faggio P02 faggio sbiancato /  
 tessuto Cros SKZ sabbia  
*beech P02 bleached beechwood /  
 Cros fabric SKZ sand*  
**CB2117** faggio P132 grafite /  
 tessuto Cros SLC limone  
*beech P132 graphite /  
 Cros fabric SLC lemon yellow*



sedie e sgabelli | chairs and stools

Tuka sedie | chairs  
**CB1994** faggio P02 faggio sbiancato /  
 tessuto Cros SKZ sabbia  
*beech P02 bleached beechwood /  
 Cros fabric SKZ sand*  
**CB1999** metallo P6L bosco opaco /  
 tessuto Cros SLG timo  
*metal P6L matt forest green /  
 Cros fabric SLG thyme green*  
**Tabla** CB4803-R  
 tavolo allungabile | *extending table*  
 faggio P02 faggio sbiancato /  
 nobilitato P84W pietra piacentina  
*beech P02 bleached beechwood /  
 melamine P84W piacentina stone*  
**Tapi** CB7224 tappeto | rug  
 polipropilene/poliestere tonalità beige  
*polypropylene/polyester shades of beige*



**Tuka sedie | chairs**  
**CB1994** faggio P02 faggio sbiancato / tessuto Cros SKZ sabbia  
*beech P02 bleached beechwood / Cros fabric SKZ sand*  
**CB1993** metallo P3L rosso ossido opaco / tessuto Cros SLE rosa  
*metal P3L matt oxide red / Cros fabric SLE pink*  
**CB1999** metallo P33L ottone verniciato / tessuto Mat SLL limone  
*metal P33L Painted Brass / Mat fabric SLL lemon yellow*

**Tuka sgabelli | stools**  
**CB1996** metallo P15 nero opaco / tessuto Mat SLQ grigio  
*metal P15 matt black / Mat fabric SLQ grey*  
**CB1997** faggio P132 grafite / tessuto Mat SLK cammello  
*beech P132 graphite / Mat fabric SLK camel brown*  
**CB1995** P6L bosco opaco / tessuto Cros SLH bosco  
*P6L matt forest green / Cros fabric SLH forest green*

**Tuka sedia lounge | lounge chair**  
**CB2114** metallo P94 bianco ottico opaco / tessuto Mat SLN rosa  
*metal P94 matt optic white / Mat fabric SLN pink*



**Tuka**  
**CB2113** sedia lounge | lounge chair  
 faggio P132 grafite / tessuto Cros SLB nero  
 beech P132 graphite / Cros fabric SLB black  
**CB2117** sedia | chair  
 faggio P132 grafite / tessuto Cros SLC limone  
 beech P132 graphite / Cros fabric SLC lemon yellow  
**Stulle** CB5209-P tavolino fisso | coffee table  
 metallo P15 nero opaco / nobilitato P84W pietra piacentina  
 metal P15 matt black / melamine P84W piacentina stone  
**Tapi** CB7224 tappeto | rug  
 polipropilene/poliestere tonalità beige  
 polypropylene/polyester shades of beige





# Yo!

collezione | collection

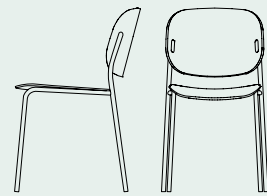

CB1986-A  
47x55,5 H81 cm

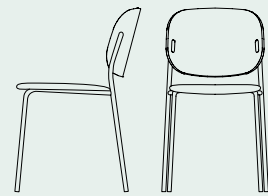

CB1986 | CB1986-N  
47x55,5 H81 cm

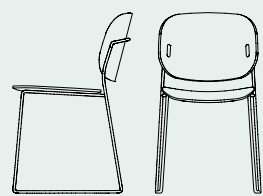

CB1988-A  
47x55,5 H81 cm

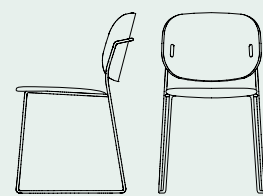

CB1988 | CB1988-N  
47x55,5 H81 cm

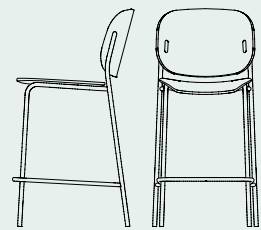

CB1987-A  
50x54 H98 HS65 cm

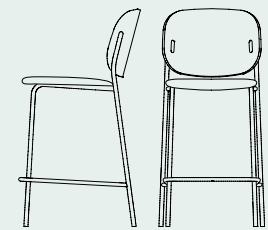

CB1987 | CB1987-N  
50x54 H98 HS67 cm

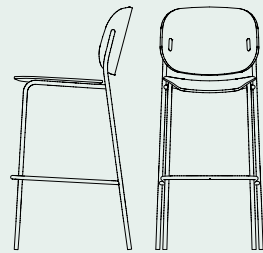

CB1992-A  
51x54 H109 HS76 cm

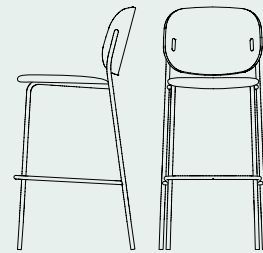

CB1992 | CB1992-N  
51x54 H109 HS78 cm

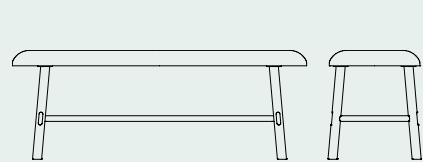

CB5210 | 130x41 H48 cm

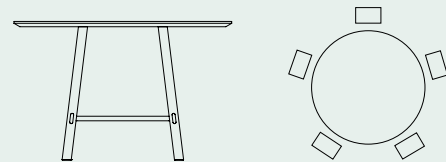

CB4805-FD 120 | Ø120 cm

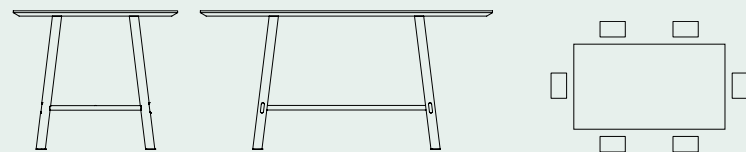

CB4805-FR 160 | 160x90 cm

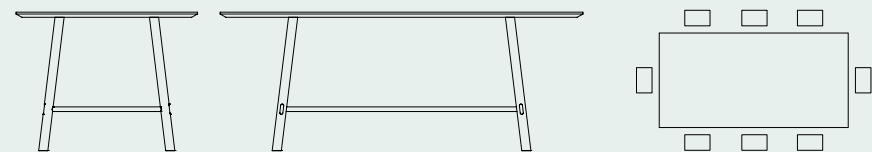

CB4805-FR 200 | 200x100 cm



Yo! CB1986 sedia | chair  
metallo P6L bosco opaco / tessuto Plain SKX timo  
metal P6L matt forest green / Plain fabric SKX thyme green



CB1986 | CB1986-A | CB188 | CB1988-A | CB1987 | CB1987-A | CB1992 | CB1992-A

NOTA per le combinazioni disponibili consultare il listino prezzi. | NOTE please check all available combinations in the price list.

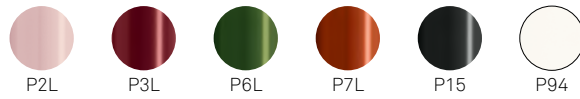
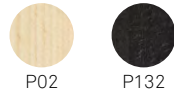
**struttura sedute**  
*seats frame*metallo | *metal***sedile**  
*seat*legno | *wood*

PP

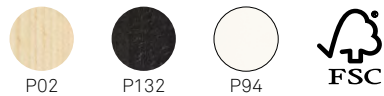
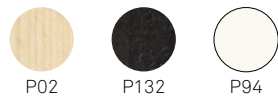
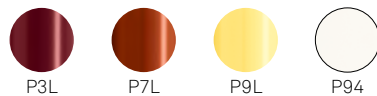
tessuto | *fabric***struttura panca**  
*bench frame*legno | *wood***struttura/piano tavoli**  
*frame/top tables*legno | *wood***crociera**  
*crossbar*metallo | *metal*

Yo! sgabelli | *stools*  
**CB1987-A** metallo P94 bianco ottico opaco / multistrato faggio P02 faggio sbiancato  
*metal P94 matt optic white / plywood beech P02 bleached beechwood*  
**CB1992** metallo P94 bianco ottico opaco / tessuto Plain SKY bosco  
*metal P94 matt optic white / Mat Plain fabric SKY forest green*

NOTA per le combinazioni disponibili consultare il listino prezzi. | *NOTE please check all available combinations in the price list.*

Yo! sgabelli in metallo | *metal stools*  
**CB1992-A** P15 nero opaco /  
 multistrato faggio P132 grafite  
*P15 matt black / plywood beech P132 graphite*  
**CB1987-A** P94 bianco ottico opaco /  
 multistrato faggio P02 faggio sbiancato  
*P94 matt optic white /  
 plywood beech P02 bleached beechwood*

Yo! sedie in metallo | *metal chairs*  
**CB1986-A** P7L zafferano opaco /  
 polipropilene P2L cipria opaco  
*P7L matt saffron yellow /  
 polypropylene P2L matt pale pink*  
**CB1988-N** P2L cipria opaco /  
 tessuto Plain SKW bordeaux  
*P2L matt pink / Plain fabric SKW burgundy*



Yo!



Yo! sedie in metallo | *metal chairs*  
**CB1986-A** P7L zafferano opaco / polipropilene P2L cipria opaco  
P7L matt saffron yellow / polypropylene P2L matt pale pink  
**CB1986-N** P7L zafferano opaco / tessuto Plain SKV rosa  
P7L matt saffron yellow / Plain fabric SKV pink

collezione | collection

Yo! sedie in metallo | *metal chairs*  
**CB1988-N** P7L zafferano opaco /  
tessuto Plain SKV rosa  
P7L matt saffron yellow /  
Plain fabric SKV pink



Yo!

Yo!  
 sgabelli in metallo | *metal stools*  
**CB1992-A** P15 nero opaco /  
 multistrato faggio P132 grafite  
*P15 matt black / plywood beech  
 P132 graphite*  
**CB1987-A** P94 bianco ottico  
 opaco / multistrato faggio P02  
 faggio sbiancato  
*P94 matt optic white / plywood  
 beech P02 bleached beechwood*  
**CB1987** P7L zafferano opaco /  
 tessuto Plain SKS nero  
*P7L matt saffron yellow / Plain  
 fabric SKS black*  
 panca in legno e metallo |  
*wooden and metal bench*  
**CB5210** faggio P02 faggio  
 sbiancato - P9L limone opaco /  
 tessuto Plain SKT limone  
*beech P02 bleached beechwood -  
 P9L lemon yellow /  
 Plain fabric SKT lemon yellow*



collezione | collection



Yo!  
 sedie in metallo | *metal chairs*  
**CB1986** P7L zafferano opaco /  
 tessuto Plain SKV rosa  
*P7L matt saffron yellow / Plain  
 fabric SKV pink*  
**CB1988** P2L cipria opaco / tessuto  
 Plain SKW bordeaux  
*metal P2L matt pink / Plain fabric  
 SKW burgundy*  
**CB1986** metallo P6L bosco opaco /  
 tessuto Plain SKX timo  
*metal P6L matt forest green /  
 Plain fabric SKX thyme green*  
 panca in legno e metallo |  
*wooden and metal bench*

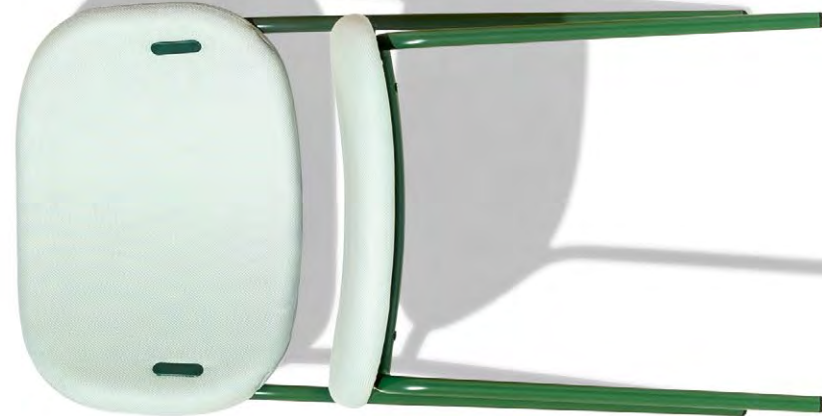

Yo!

Yo! CB1986-A sedie | chairs  
metallo P7L zafferano opaco /  
tessuto Plain SKS nero  
metal P7L matt saffron yellow /  
Plain fabric SKS black



collezione | collection



Yo! CB1988 sedie | chairs  
metallo P7L zafferano opaco / tessuto Plain SKS nero  
metal P7L matt saffron yellow / Plain fabric SKS black



Yo! CB5210 panca in legno e metallo | *wooden and metal bench*  
 faggio P132 grafite - P7L zafferano opaco / tessuto Plain SKU zafferano  
 beech P132 graphite - P7L matt saffron yellow / Plain fabric SKU saffron yellow

Yo! CB5210 panca in legno e metallo |  
*wooden and metal bench*  
 faggio P132 grafite - P7L zafferano opaco /  
 tessuto Plain SKU zafferano  
 beech P132 graphite - P7L matt saffron yellow /  
 Plain fabric SKU saffron yellow  
**App** CB5212 appendiabiti | *coat stands / hangers*  
 faggio P132 faggio grafite / metallo P15 nero opaco  
 beech P132 graphite / metal P15 matt black



Yo! CB4805-FR 200  
 tavolo fisso in legno e metallo |  
*wooden and metal non-extending table*  
 faggio P02 faggio sbiancato - P9L limone opaco  
*beech P02 bleached beechwood - P9L lemon yellow*  
 Yo! CB5210 panca in legno e metallo |  
*wooden and metal bench*  
 faggio P02 faggio sbiancato -  
 P9L limone opaco / tessuto Plain SKT limone  
*beech P02 bleached beechwood -*  
*P9L lemon yellow / Plain fabric SKT lemon yellow*  
 Cletia CB2120 sedia in legno | *wooden chair*  
 faggio P02 faggio sbiancato /  
 tessuto Plain SKT limone  
*beech P02 bleached beechwood /*  
*Plain fabric SKT lemon yellow*







Yo! CB4805-FR 200 tavolo fisso in legno e metallo | wooden and metal *non-extending table*  
 faggio P02 faggio sbiancato - P9L limone opaco  
 beech P02 bleached beechwood - P9L lemon yellow  
 Yo! CB5210 panca in legno e metallo | wooden and metal *bench*  
 faggio P02 faggio sbiancato - P9L limone opaco / tessuto Plain SKT limone  
 beech P02 bleached beechwood - P9L lemon yellow / Plain fabric SKT lemon yellow



Yo! tavolo fisso in legno e metallo | wooden and metal *non-extending table*  
 CB4805-FR 200 faggio P02 faggio sbiancato - P9L limone opaco  
 beech P02 bleached beechwood - P9L lemon yellow

Yo!

Yo!  
tavolo fisso in legno e metallo |  
wooden and metal *non-extending table*  
CB4805-FD 120 faggio P132 grafite - P7L zafferano opaco  
beech P132 graphite - P7L matt saffron yellow  
panca in legno e metallo | wooden and metal bench  
CB5210 faggio P132 grafite - P7L zafferano opaco /  
tessuto Plain SKU zafferano  
beech P132 graphite - P7L matt saffron yellow /  
Plain fabric SKU saffron yellow



collezione | collection



Yo! CB4805-FD 120 tavolo fisso in legno e metallo |  
wooden and metal *non-extending table*  
faggio P132 grafite - P7L zafferano opaco  
beech P132 graphite - P7L matt saffron yellow

# DISCOVER THE CLASSIC CONNUBIA COLLECTION

È la sezione dedicata ai “fondamentali” della casa e degli spazi: tavoli e sedie, portati al massimo livello di profondità di gamma. Una straordinaria collezione di sedie dalle forme classiche e senza tempo oppure avveniristiche e ricche di dettagli. Sedie dal design ergonomico e contemporaneo, corredate da un’ampia gamma di tavoli. Protagonisti della zona pranzo, i tavoli Connubia rispondono ad ogni esigenza di convivialità, trasformandosi all’occorrenza per accogliere ospiti inattesi ed adattandosi a ogni spazio e necessità.

*This section is dedicated to “fundamentals” for the home and living spaces - tables and chairs raised to the highest level in terms of range of solutions. An extraordinary spectrum made up of chairs which have a classic-looking timeless appeal or boast a futuristic design with intricate details. Chairs with an ergonomic contemporary design accompanied by a broad array of tables. A major player in the dining area, Connubia tables have been carefully designed to cater for social needs and can be transformed whenever necessary to welcome unexpected guests, adapting to any spaces or requirements.*



# **sedie** | *chairs*

sedie | chairs | sgabelli | stools | sedie  
pieghevoli | folding chairs | sedie home  
office | home office chairs

# Academy



CB1665  
44,5x51 H84 cm

CB1672  
47x50 H106 HS66 cm

CB1673  
50x50 H121 HS81 cm

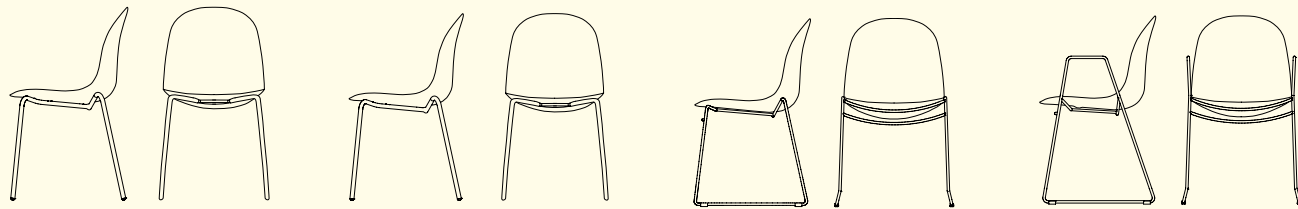

CB1663  
49x51 H84 cm

CB1671 | CB1671-E  
53,5x52,5 H83 cm

CB1696 | CB1696-N  
54x52 H83 cm

CB1697 | CB1697-N  
54x52 H83 HB70 cm



CB1664  
44,5x51 H84 cm

CB1694 180 | CB1694 360  
49x50 H85 cm

CB1911  
63x63 H92(83,5) cm

CB1695  
61x57 H92(81) cm

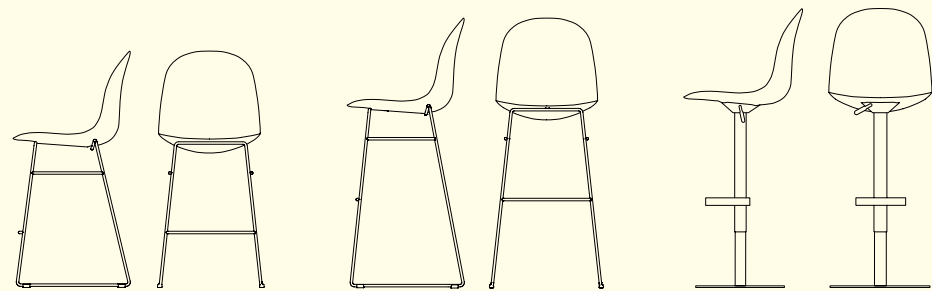

CB1674  
48x55 H104 HS66 cm

CB1675  
50x53 H119 HS81 cm

CB1676  
44x49 H123(104) HS85(66) cm



CB1696  
CB1671 | CB1671-E  
CB1697



CB1671-E



CB1694 180



CB1694 360  
CB1911 | CB1695  
CB1676



CB1695 | CB1911  
CB1676

NOTA per le combinazioni disponibili consultare il listino prezzi. | NOTE please check all available combinations in the price list.



Academy CB1663 sedia | chair  
metallo P33L ottone verniciato / tessuto Mat SLL limone  
metal P33L painted brass / Mat fabric SLL lemon yellow

**struttura**  
*frame*

legno | *wood*

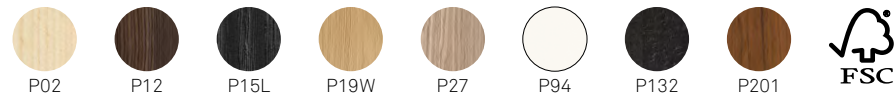

metallo | *metal*



**sedile**  
*seat*

PP

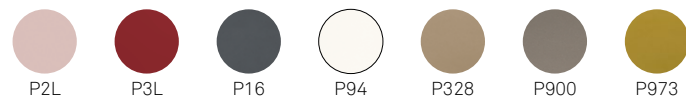

tessuto | *fabric*

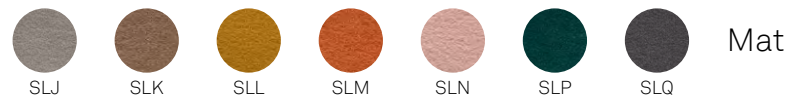

similpelle | *faux leather*



rig. cuoio | *reg. leather*



CB1672 | CB1673 SGABELLI CON POGGIPIEDI CROMATO | STOOLS WITH CHROMED FOOTREST

**ACCESSORI | ACCESSORIES**



**CB1966** bracciolo per modelli: | *armrest for models:* CB1694 180, CB1694 360, CB1695



**CB1677** tavoletta con meccanismo antipanico per modello: | *tablet with anti-panic mechanism for model:* CB1697, CB1697-N



**CB1678-1** gancio per fissare n. 2 sedie modello: | *linking system for 2 chairs models:* CB1696, CB1696-N, CB1697, CB1697-N



**CB5101** carrello portasedie per modelli: | *chair trolley for models:* CB1671, CB1671-E, CB1696, CB1697

NOTA per le combinazioni disponibili consultare il listino prezzi. | *NOTE please check all available combinations in the price list.*



**Academy CB1665** sedia | *chair*  
frassino P19W rovere naturale / polipropilene P2L cipria opaco  
ashwood P19W natural oak / polypropylene P2L matt pale pink



**Academy**  
sedia e sgabelli in legno | wooden chair and stools  
**CB1665** faggio P132 grafite / tessuto Mat SLL limone  
beech P132 graphite / Mat fabric SLL lemon yellow  
**CB1672 CB1673** faggio P132 grafite / tessuto Mat SLM zafferano  
beech P132 graphite / Mat fabric SLM saffron yellow



**Academy**  
 sedie e sgabelli in legno |  
 wooden chairs and stools  
**CB1665** faggio P132 grafite /  
 polipropilene P3L rosso ossido opaco  
 beech P132 graphite /  
 polypropylene P3L matt oxide red  
 faggio P02 faggio sbiancato /  
 rigenerato di cuoio R04 cognac -  
 tessuto Mat SLQ grigio  
 beech P02 bleached beechwood /  
 regenerated leather R04 cognac -  
 Mat fabric SLQ grey  
**CB1672** faggio P02 faggio sbiancato /  
 similpelle Vintage SOX canapa  
 beech P02 bleached beechwood /  
 Vintage faux leather SOX hemp  
**CB1673** faggio P132 grafite /  
 similpelle Ekos G8N nero  
 beech P132 graphite /  
 Ekos faux leather G8N black



**Academy**  
sedie e sgabelli | *chairs and stools*  
metallo P15 nero opaco / similpelle Ekos G8N nero  
*metal P15 matt black / Ekos faux leather G8N black*



Academy CB1663 sedie | chairs  
 metallo P33L ottone verniciato /  
 tessuto Mat SLP bosco - SLQ grigio -  
 SLJ sabbia - SLN rosa - SLK cammello -  
 SLM zafferano - SLL limone  
 metal P33L Painted Brass /  
 Mat fabric SLP forest green - SLQ grey -  
 SLJ sand - SLN pink - SLK camel brown -  
 SLM saffron yellow - SLL lemon yellow



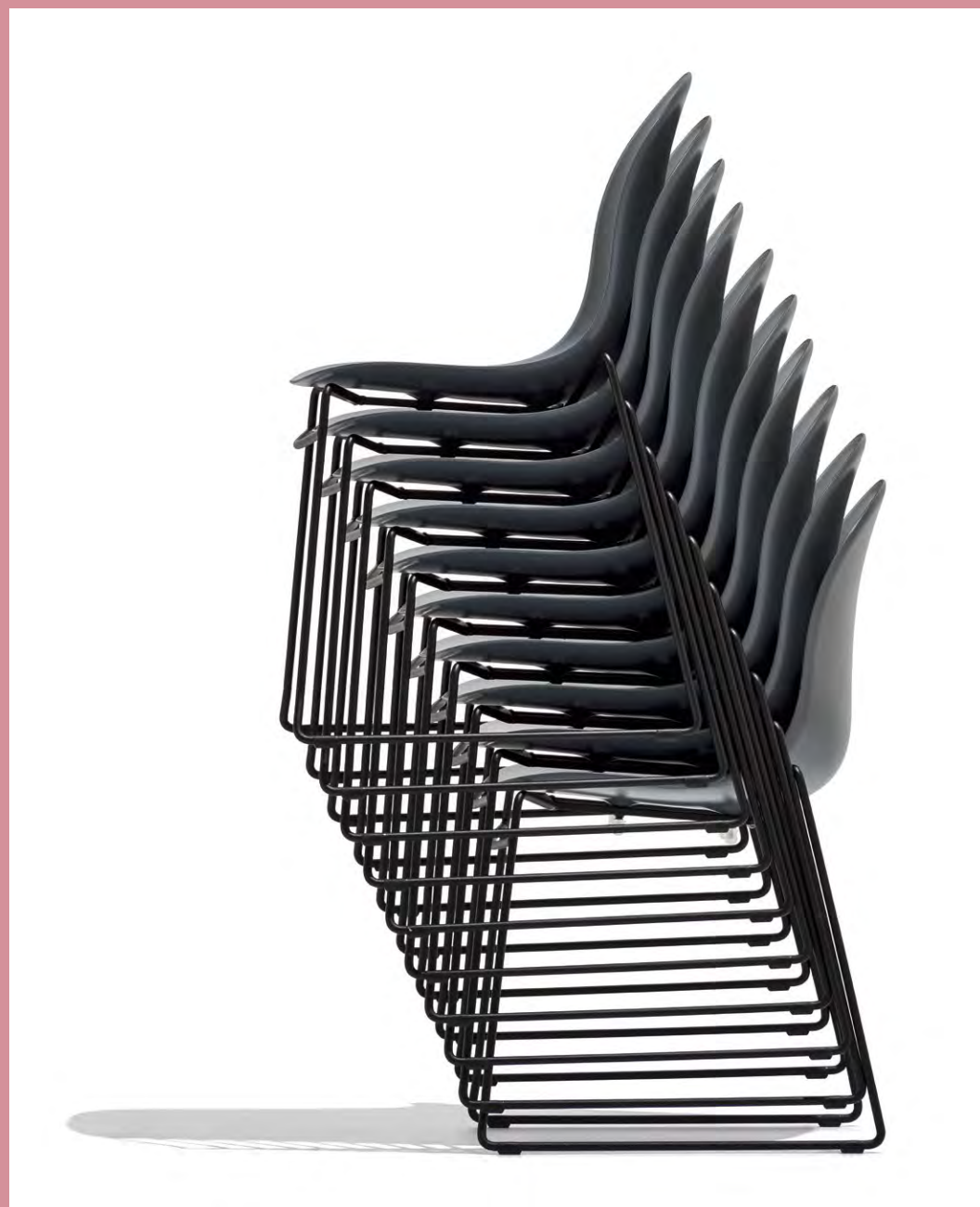

Academy CB1696 sedia | chair  
metallo P15 nero opaco / polipropilene P16 grigio opaco  
metal P15 matt black / polypropylene P16 matt grey



Academy CB1664 sedia | chair  
metallo P3L rosso ossido opaco /  
polipropilene P3L rosso ossido opaco  
metal P3L matt oxide red /  
polypropylene P3L matt oxide red

**Academy**

sedie e sgabelli in metallo |  
*mrtal chairs and stools*

**CB1674** P15 nero opaco /  
 similpelle Ekos G8N nero  
*P15 matt black / Ekos faux  
 leather G8N black*  
**CB1664** P2L cipria opaco /  
 polipropilene P2L cipria opaco  
*P2L matt pale pink /  
 polypropylene P2L matt pale pink*  
**CB1675** P15 nero opaco /  
 similpelle Vintage S0B tabacco  
*P15 matt black / Vintage faux  
 leather S0B tobacco*  
**CB1697** P15 nero opaco /  
 similpelle Ekos G8N nero  
*P15 matt black / Ekos faux  
 leather G8N black*  
**CB1696** P15 nero opaco /  
 similpelle Vintage  
 S0A deserto  
*P15 matt black / Vintage  
 faux leather S0A desert*  
**CB1676** P77 cromato /  
 tessuto Mat SLP bosco  
*P77 chromed /  
 Mat fabric SLP forest green*  
**CB1694 180** P94 bianco  
 ottico opaco / polipropilene  
 P94 bianco ottico opaco  
*P94 matt optic white /  
 polypropylene P94 matt  
 optic white*  
**CB1911** P77 cromato /  
 similpelle Ekos G8N nero  
*P77 chromed / Ekos faux  
 leather G8N black*  
**CB1663** sedia | chair  
 P3L rosso ossido opaco /  
 polipropilene P3L rosso  
 ossido opaco  
*P3L matt oxide red /  
 polypropylene P3L matt  
 oxide red*  
**CB1695 - CB1966** P15 nero  
 opaco / tessuto Mat  
 SLK cammello  
*P15 matt black /  
 Mat fabric SLK camel brown*



# Ace

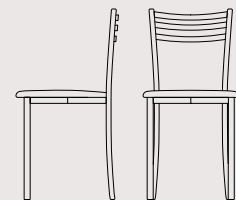

CB1320 | 42x45 H84 cm

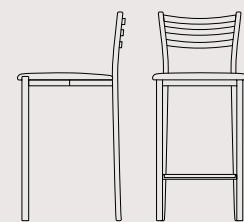

CB1329 | 41,5x48 H92 HS 65 cm

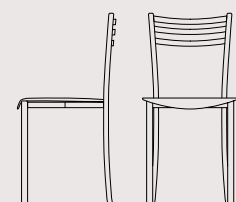

CB1693 | 42x45 H84 cm

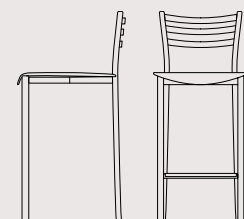

CB1692 | 41,5x48 H92 HS 65 cm

## struttura frame

metallo | metal



## sedile seat

legno | wood



PP

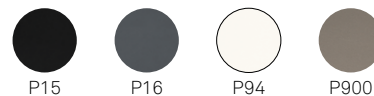

similpelle | faux leather

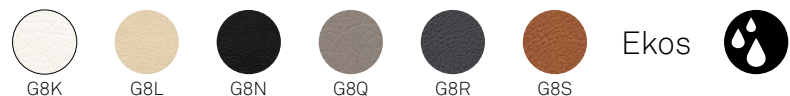

materiali sintetici |  
synthetic fabrics



NOTA per le combinazioni disponibili consultare il listino prezzi. | NOTE please check all available combinations in the price list.



Ace sedia e sgabello in metallo | metal chair and stool  
 CB1329 P15 nero opaco / similpelle Ekos G8N nero  
 P15 matt black / Ekos faux leather G8N black  
 CB1320 P94 bianco ottico opaco / polipropilene P94 bianco ottico opaco  
 P94 matt optic white / polypropylene P94 matt optic white



**Ace sgabello in metallo | metal stool**  
**CB1329** P309 acciaio satinato monostrato / polipropilene P15 nero opaco  
*P309 single-layer satin fin. steel / polypropylene P15 matt black*

**Ace sedie in metallo | metal chairs**  
**CB1320** P94 bianco ottico opaco / multistrato faggio P02 faggio sbiancato  
*P94 matt optic white / plywood beech P02 bleached beechwood*  
**CB1693** P94 bianco ottico opaco / multistrato rovere P507 bianco ottico spazzolato  
*P94 matt optic white / plywood oak P507 brushed optic white*



# Air

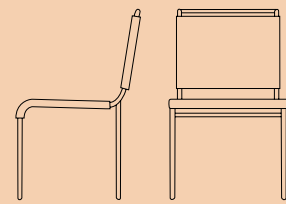

CB93 | 53x55 H84 cm

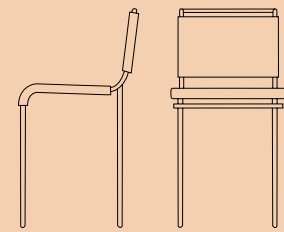

CB57 | 51x53 H96,5 HS65 cm

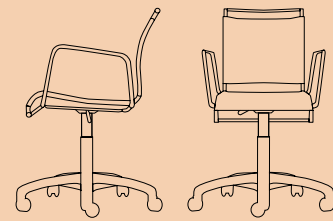

Air Race CB321 | 60x64 H92(83) HB 75(66) cm

## struttura frame

metallo | metal



## sedile seat

materiali sintetici |  
synthetic fabrics

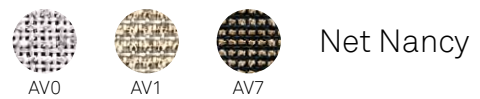

Air sedia e sgabello in metallo | metal chair and stool  
**CB93** P15 nero opaco / materiale sintetico Net 461 nero  
 P15 matt black / Net synthetic fabric 461 black  
**CB57** P77 cromato / materiale sintetico Net 459 bianco ottico  
 P77 chromed / Net synthetic fabric 459 optic white

NOTA per le combinazioni disponibili consultare il listino prezzi. | NOTE please check all available combinations in the price list.

# Air High

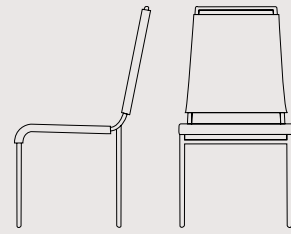

CB1069 | 51x60 H97,5 cm

## struttura frame

metallo | *metal*

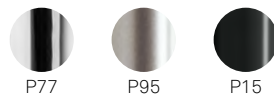

## sedile seat

materiali sintetici |  
*synthetic fabrics*



NOTA per le combinazioni disponibili consultare il listino prezzi. | *NOTE please check all available combinations in the price list.*



**Air High** CB1069 sedia | *chair*  
metallo P15 nero opaco / materiale sintetico Net Nancy AV7 Sahara  
*metal P15 matt black / Net Nancy synthetic fabric AV7 Sahara*



# Alchemia

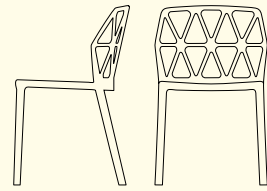

CB1056 | 49,5x51 H79 cm

**struttura/sedile**  
*frame/seat*

PP



P15



P94



P100



P328



P900



P973



sedie e sgabelli | chairs and stools



**Alchemia** CB1056 sedia | *chair*  
polipropilene P973 senape opaco  
*polypropylene P973 matt mustard yellow*



**Alchemia CB1056**  
 sedia in polipropilene | *polypropylene chair*  
 P15 nero opaco | *P15 matt black*  
 P900 tortora opaco | *P900 matt taupe*  
 P94 bianco ottico opaco | *P94 matt optic white*  
 P328 nocciola opaco | *P328 matt nougat*  
 P973 senape opaco | *P973 matt mustard yellow*  
 P100 sky blue opaco | *P100 matt sky blue*

**Alchemia CB1056**  
 sedia in polipropilene | *polypropylene chair*  
 P973 senape opaco | *P973 matt mustard yellow*  
 P328 nocciola opaco | *P328 matt nougat*  
 P900 tortora opaco | *P900 matt taupe*  
 P94 bianco ottico opaco | *P94 matt optic white*  
 P15 nero opaco | *P15 matt black*



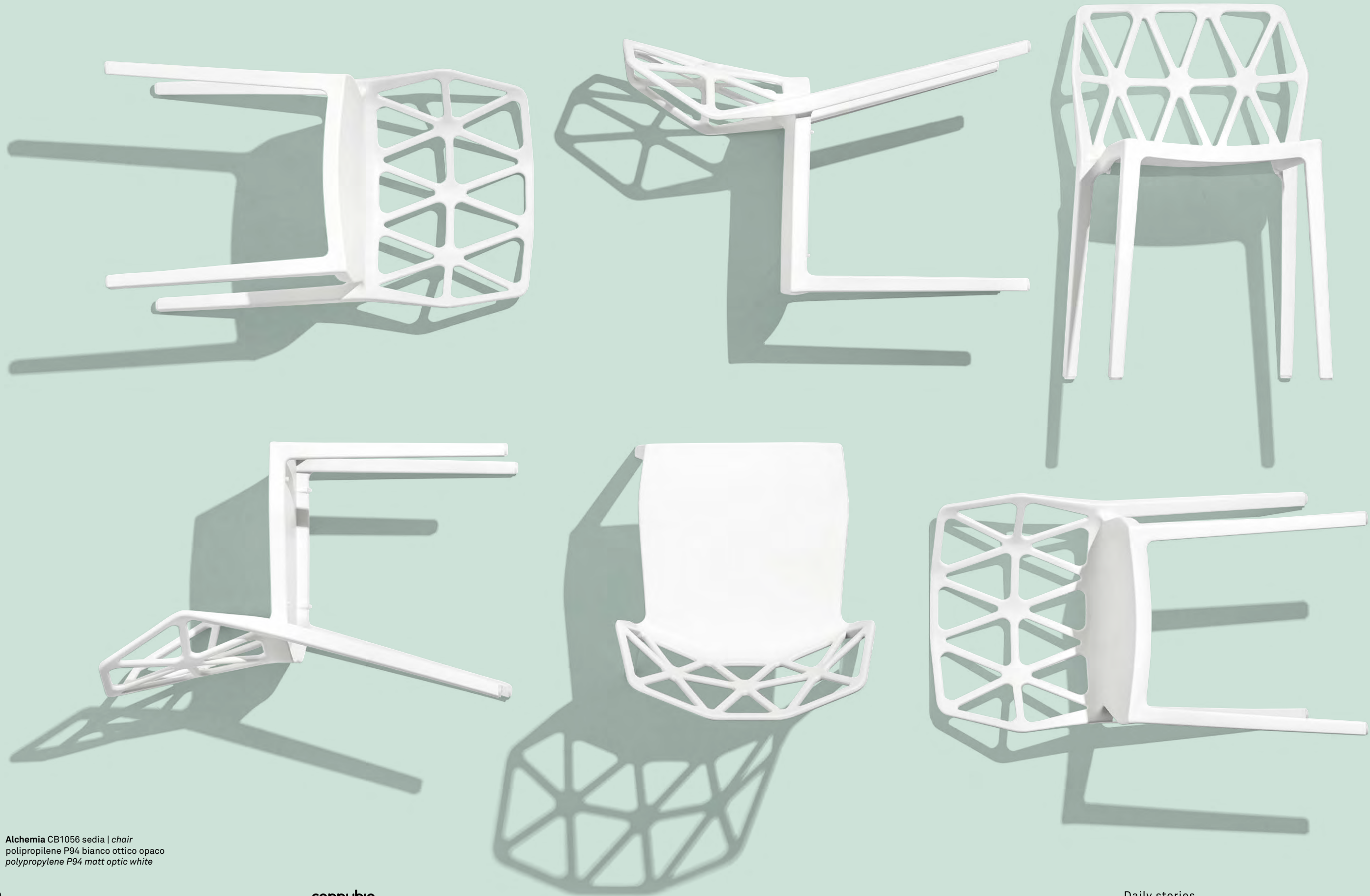

Alchemia CB1056 sedia | chair  
polipropilene P94 bianco ottico opaco  
polypropylene P94 matt optic white

# Area51

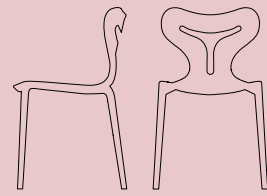

CB1042 | 50,5x50 H80 cm

## struttura/sedile frame/seat

PP

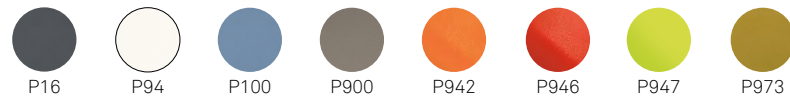

sedie e sgabelli | chairs and stools



**Area51** CB1042  
sedia in polipropilene | *polypropylene chair*  
P94 bianco ottico opaco | *P94 matt optic white*



Area51 CB1042 sedia in polipropilene | *polypropylene chair*  
P94 bianco ottico opaco | *P94 matt optic white*



Area51 CB1042  
sedia in polipropilene | *polypropylene chair*  
P900 tortora opaco | *P900 matt taupe*  
P100 sky blue opaco | *P100 matt sky blue*  
P16 grigio opaco | *P16 matt grey*  
P973 senape opaco | *P973 matt mustard yellow*

# Argo

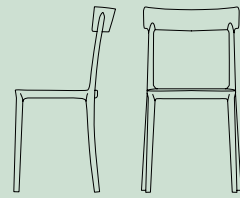

CB1523 | 48x47 H82 cm

## struttura/sedile frame/seat

PP



P15



P94



P100



P328



P900



P946



P973



sedie e sgabelli | chairs and stools



Argo CB1523  
sedia in polipropilene | polypropylene chair  
P15 nero opaco | P15 matt black



Argo CB1523  
sedia in polipropilene | *polypropylene chair*  
P94 bianco ottico opaco | *P94 matt optic white*



Argo CB1523 sedia in polipropilene | *polypropylene chair*  
P973 senape opaco | *P973 matt mustard yellow*  
P94 bianco ottico opaco | *P94 matt optic white*  
P100 sky blue opaco | *P100 matt sky blue*  
P900 tortora opaco | *P900 matt taupe*

Argo CB1523  
sedia in polipropilene | *polypropylene chair*  
P973 senape opaco | *P973 matt mustard yellow*  
P100 sky blue opaco | *P100 matt sky blue*  
P94 bianco ottico opaco | *P94 matt optic white*  
P900 tortora opaco | *P900 matt taupe*  
P328 nocciola opaco | *P328 matt nougat*  
P15 nero opaco | *P15 matt black*





# Aurora

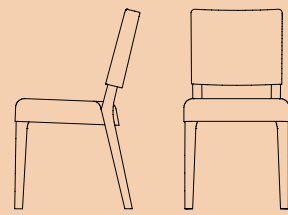

CB1963 | 47x56 H88 cm

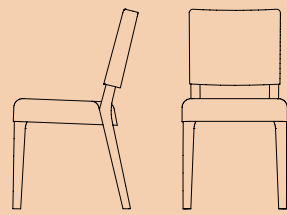

CB1963-S | 47x56 H88 cm

sedie e sgabelli | chairs and stools



## struttura frame

legno | wood



## sedile seat

tessuto | fabric

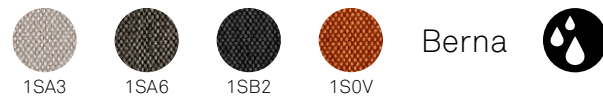

CB1963-S

**Aurora** CB1963-S sedia | chair  
faggio P15 nero opaco / tessuto Berna 1S0V arancione  
beech P15 matt black / Berna fabric 1S0V orange

NOTA per le combinazioni disponibili consultare il listino prezzi. | NOTE please check all available combinations in the price list.

# Boheme

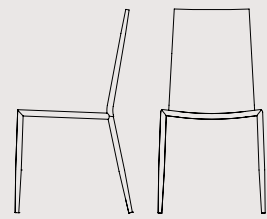

CB1257 | 48x52 H90 cm

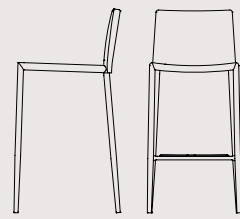

CB1393 | 43x49,5 H90 HS65 cm

## struttura frame

metallo | *metal*



## sedile seat

rigenerato di cuoio |  
*regenerated leather*



sedie e sgabelli | *chairs and stools*



**Boheme CB1257 sedia | *chair***  
metallo P176 tortora opaco / rigenerato di cuoio D03 tortora  
*metal P176 matt taupe / regenerated leather D03 taupe*

NOTA per le combinazioni disponibili consultare il listino prezzi. | *NOTE please check all available combinations in the price list.*



**Boheme CB1393** sgabello | stool  
metallo P15 nero opaco / rigenerato di cuoio 315 nero  
metal P15 matt black / regenerated leather 315 black

**Boheme CB1257**  
sedie in metallo e rigenerato di cuoio |  
metal and regenerated leather chairs  
P176 tortora opaco / D03 tortora  
P176 matt taupe / D03 taupe  
P94 bianco ottico opaco / 474 bianco ottico  
P94 matt optic white / 474 optic white  
P15 nero opaco / 315 nero  
P15 matt black / 315 black



# Caffè

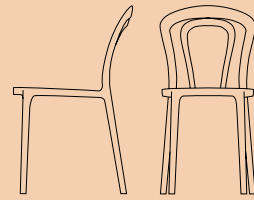

CB1970 | 43x53 H83 cm

## struttura/sedile frame/seat

PP



sedie e sgabelli | chairs and stools



**Caffè CB1970**  
sedia in polipropilene | polypropylene chair  
P15 nero opaco | P15 matt black

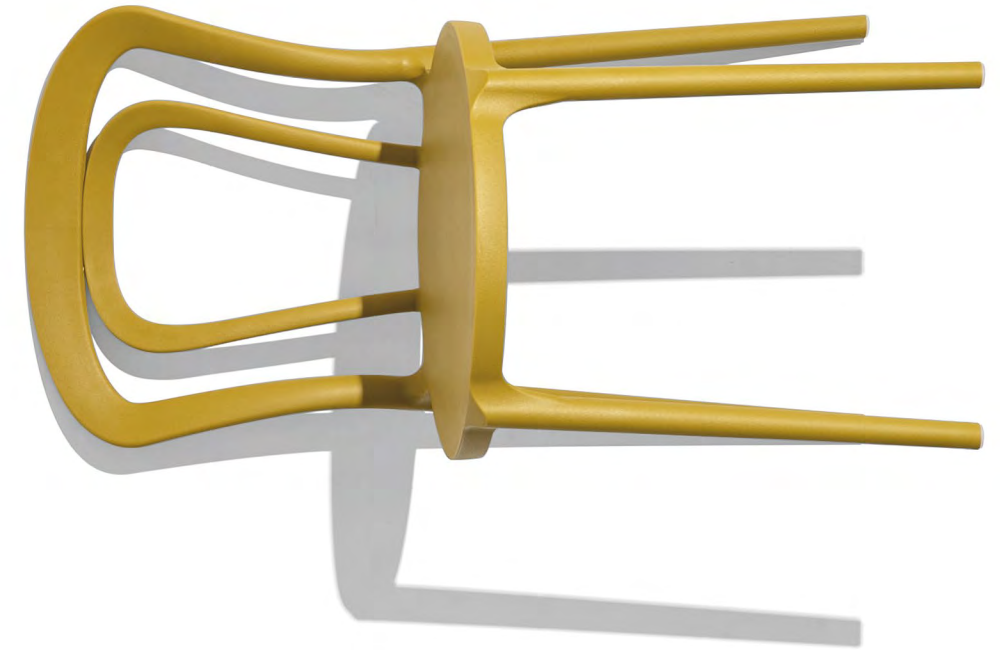
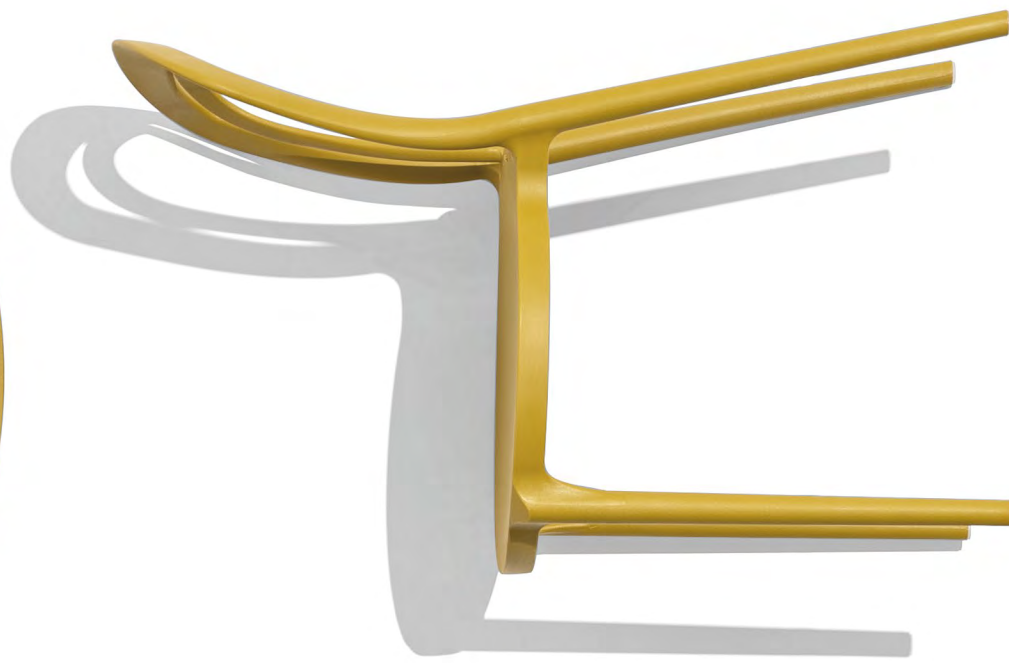
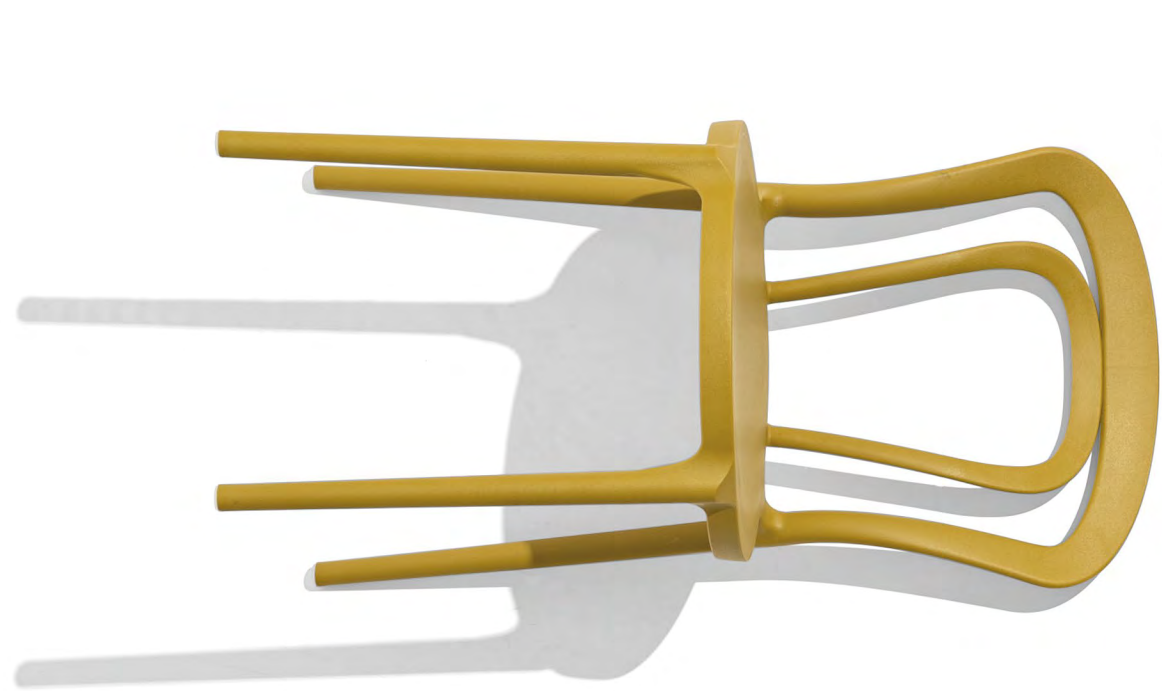

**Caffè CB1970**  
sedia in polipropilene | polypropylene chair  
P973 senape opaco | P973 matt mustard yellow

**Caffè CB1970**  
sedia in polipropilene | *polypropylene chair*  
P900 tortora opaco | *P900 matt taupe*  
P94 bianco ottico opaco | *P94 matt optic white*  
P100 sky blue opaco | *P100 matt sky blue*



# Clip

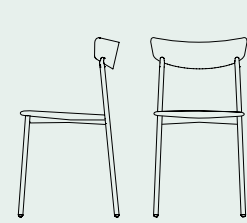

CB1974 | 43x45 H79 cm

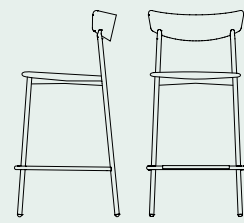

CB1975 | 45x47,5 H91 HS66 cm

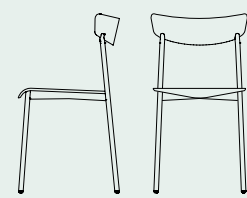

CB1971 | 43x45 H79 cm

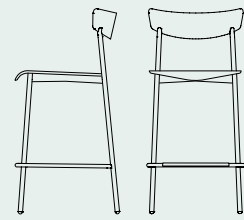

CB1972 | 45x47,5 H91 HS65 cm

## struttura frame

metallo | metal



## sedile seat

legno | wood



PP

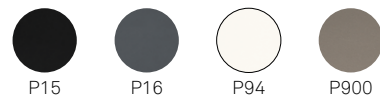

similpelle | faux leather



materiali sintetici |  
synthetic fabrics



sedie e sgabelli | chairs and stools



Clip CB1974 sedia | chair  
metallo P15 nero opaco / materiale sintetico Carbon Look 481  
metal P15 matt black / Carbon Look synthetic fabric 481

Clip sedie e sgabello in metallo |  
*metal chairs and stool*  
**CB1971** P94 bianco ottico opaco /  
 multistrato rovere P507 bianco ottico spazzolato  
*P94 matt optic white /*  
*plywood oak P507 brushed optic white*  
**CB1975** P15 nero opaco / similpelle Ekos G8N nero  
*P15 matt black / Ekos faux leather G8N black*  
**CB1974** P95 acciaio satinato /  
 materiale sintetico Carbon Look 481  
*P95 satin finished steel /*  
*Carbon Look synthetic fabric 481*  
**CB1974** P176 tortora opaco /  
 similpelle Ekos G8Q tortora  
*P176 matt taupe / Ekos faux leather G8Q taupe*





# Club

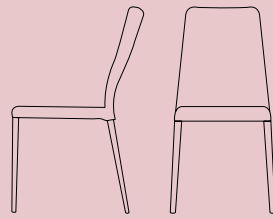

CB1462 | 47x57 H91 cm

sedie e sgabelli | chairs and stools



## struttura frame

metallo | tessuto  
metal | fabric

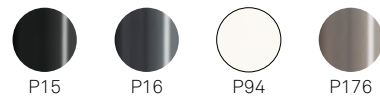

## sedile seat

tessuto | fabric

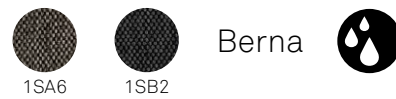

similpelle | faux leather



NOTA per le combinazioni disponibili consultare il listino prezzi. | NOTE please check all available combinations in the price list.

Club CB1462 sedia | chair  
metallo P94 bianco ottico opaco / similpelle Ekos G8K bianco  
metal P94 matt optic white / Ekos faux leather G8K white

# Copenhagen

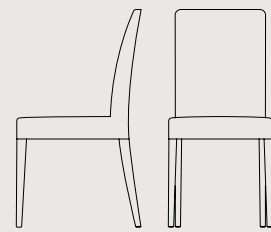

CB1656 | 47x55 H96 cm

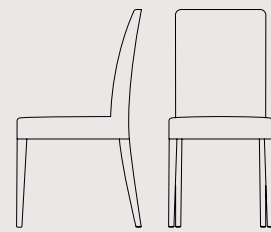

CB1656-S | 47x55 H96 cm

## struttura frame

legno | wood

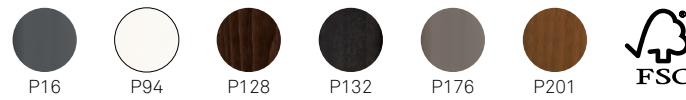

## sedile seat

tessuto | fabric



similpelle | faux leather



NOTA per le combinazioni disponibili consultare il listino prezzi. | NOTE please check all available combinations in the price list.



Copenhagen CB1656 sedia | chair  
faggio P132 grafite / similpelle Bedford S7K tortora  
beech P132 graphite / Bedford faux leather S7K taupe

**Copenhagen CB1656-S** sedie in legno | *wooden chairs*  
faggio P94 bianco ottico opaco / tessuto Cros SKZ sabbia  
*beech P94 matt optic white / Cros fabric SKZ sand*  
faggio P132 grafite / tessuto Cros SLB nero  
*beech P132 graphite / Cros fabric SLB black*  
faggio P176 tortora opaco / tessuto Cros SLA tortora  
*beech P176 matt taupe / Cros fabric SLA taupe*



# Cosmopolitan

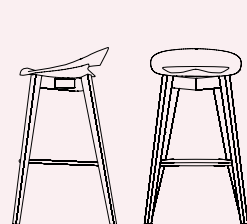

CB1939  
46,5x46 H78 HS65 cm

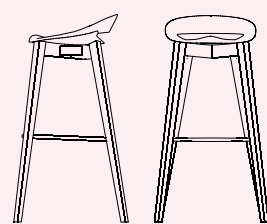

CB1940  
50x50 H93 HS80 cm

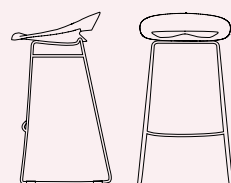

CB1941  
47x50 H76 HS65 cm

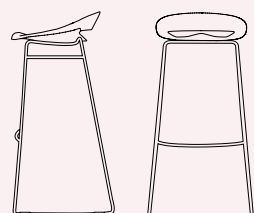

CB1942  
50x50 H91,5 HS80 cm

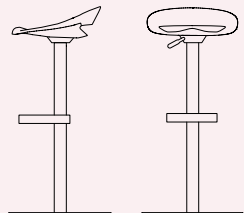

CB1943  
44x43,5 H94(77) HS80(63) cm

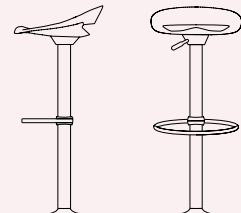

CB1944  
44x42,5 H95(70) HS81(56) cm

## struttura frame

legno | wood



metallo | metal

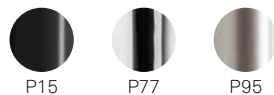

## sedile seat

PP

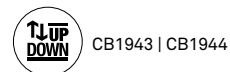
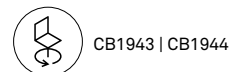
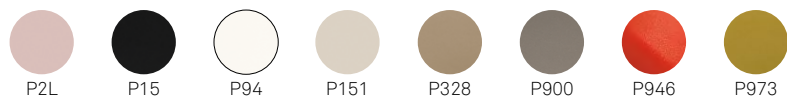

CB1939 | CB1940 SGABELLI CON POGGIPIEDI CROMATO | STOOLS WITH CHROMED FOOTREST

NOTA per le combinazioni disponibili consultare il listino prezzi. | NOTE please check all available combinations in the price list.



Cosmopolitan CB1941 sgabello | stool  
metallo P15 nero opaco / polipropilene P2L cipria opaco  
metal P15 matt black / polypropylene P2L matt pale pink

Cosmopolitan sgabelli in legno  
con sedile in polipropilene | *wooden  
stools with polypropylene seat*  
**CB1939** faggio P132 grafite / P2L cipria opaco  
*beech P132 graphite / P2L matt pale pink*  
**CB1940** frassino P19W rovere  
*naturale / P151 canapa opaco*  
*ashwood P19W natural oak / P151 matt hemp*  
 Cosmopolitan sgabelli in metallo  
 con sedile in polipropilene | *metal  
stools with polypropylene seat*  
**CB1944** P15 nero opaco / P900 tortora opaco  
*P15 matt black / P900 matt taupe*  
**CB1943** P77 cromato / P94 bianco ottico opaco  
*P77 chromed / P94 matt optic white*



Cosmopolitan sgabelli in metallo  
con sedile in polipropilene | *metal  
stools with polypropylene seat*  
**CB1941** P15 nero opaco /  
*P15 nero opaco*  
*P15 matt black / P15 matt black*  
**CB1942** P15 nero opaco /  
*P94 bianco ottico opaco*  
*P15 matt black /*  
*P94 matt optic white*



# Emma

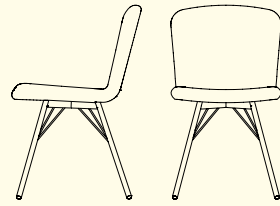

CB1662 | 48,5x57 H85,5 cm

## struttura frame

metallo | *metal*



## sedile seat

similpelle | *faux leather*

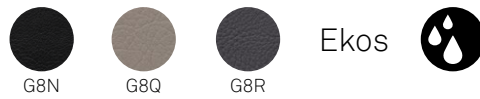

sedie e sgabelli | chairs and stools



Emma CB1662 sedia | chair  
metallo P16 grigio opaco / similpelle Ekos G8R grigio  
metal P16 matt grey / Ekos faux leather G8R grey

NOTA per le combinazioni disponibili consultare il listino prezzi. | NOTE please check all available combinations in the price list.

# Escudo

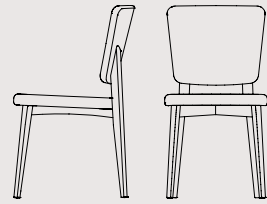

CB1526 | 45x53 H85 cm

## struttura frame

legno | wood

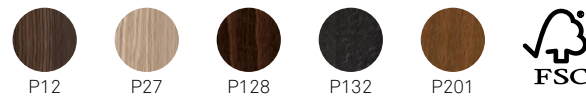

## sedile seat

tessuto | fabric



similpelle | faux leather

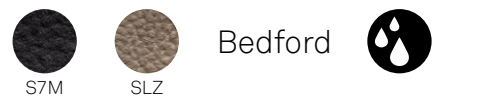

sedie e sgabelli | chairs and stools



Escudo CB1526 sedia | chair  
frassino P27 natural / tessuto Berna 1SA3 sabbia  
ashwood P27 natural / Berna fabric 1SA3 sand

NOTA per le combinazioni disponibili consultare il listino prezzi. | NOTE please check all available combinations in the price list.



**Escudo** CB1526 sedia | chair  
frassino P27 natural / tessuto Berna 1SA3 sabbia  
ashwood P27 natural / Berna fabric 1SA3 sand



**Escudo** CB1526 sedie | chairs  
frassino P12 smoke /  
similpelle Ekos G8J moka  
ashwood P12 smoke /  
Ekos faux leather G8J moka  
faggio P201 noce /  
similpelle Bedford SLZ fango  
beech P201 walnut /  
Bedford faux leather SLZ mud brown



# Evergreen

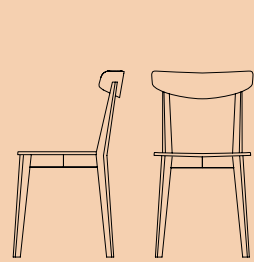

CB1139 | 44x51 H82 cm

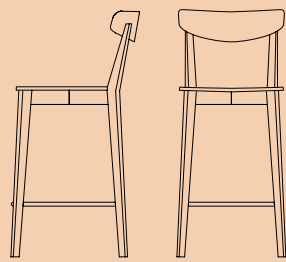

CB1140 | 44x46 H95 HS65 cm

## struttura/sedile frame/seat

legno | wood



P94



P132



P176

SGABELLO CON POGGIAPIEDI CROMATO | STOOL WITH CHROMED FOOTREST

sedie e sgabelli | chairs and stools



**Evergreen** sedie e sgabello in faggio |  
beech chairs and stool  
**CB1139** P132 grafite /  
multistrato faggio P132 grafite  
P132 graphite /  
plywood beech P132 graphite  
P94 bianco ottico opaco / multistrato  
faggio P94 bianco ottico opaco  
P94 matt optic white /  
plywood beech P94 matt optic white  
**CB1140** P176 tortora opaco /  
multistrato faggio P176 tortora opaco  
P176 matt taupe /  
plywood beech P176 matt taupe

# Gamera

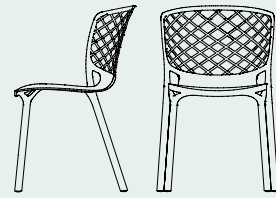

CB1459 | 53x53 H82 cm

## struttura/sedile frame/seat

nylon



sedie e sgabelli | chairs and stools



**Gamera CB1459**  
sedia in nylon | nylon chair  
P328 nocciola opaco | P328 matt nougat



**Gamera CB1459** sedia in nylon | nylon chair  
 P94 bianco ottico opaco - P328 nocciola opaco - P973 senape opaco -  
 P900 tortora opaco - P100 sky blue opaco - P15 nero opaco  
 P94 matt optic white - P328 matt nougat - P973 matt mustard yellow -  
 P900 matt taupe - P100 matt sky blue - P15 matt black



**Gamera CB1459**  
 sedia in nylon | nylon chair  
 P328 nocciola opaco  
 P328 matt nougat  
 P15 nero opaco  
 P15 matt black  
 P900 tortora opaco  
 P900 matt taupe  
 P100 sky blue opaco  
 P100 matt sky blue  
 P973 senape opaco  
 P973 matt mustard yellow



# Garda

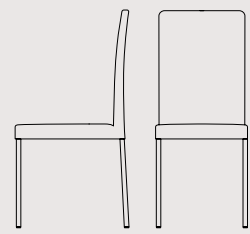

CB1525 | 44x54 H96 cm

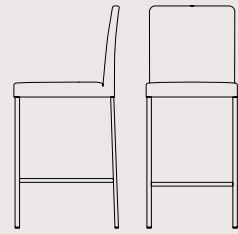

CB1688 | 44,5x50,6 H98 HS65 cm

## struttura/sedile frame/seat

metallo | metal



## sedile seat

similpelle | faux leather



sedie e sgabelli | chairs and stools



Garda sedia e sgabello in metallo | metal chair and stool  
**CB1525** P16 grigio opaco / similpelle Bedford S7K tortora  
 P16 matt grey / Bedford faux leather S7K taupe  
**CB1688** P94 bianco ottico opaco / similpelle Ekos G8K bianco  
 P94 matt optic white / Ekos faux leather G8K white

NOTA per le combinazioni disponibili consultare il listino prezzi. | NOTE please check all available combinations in the price list.

# Go!

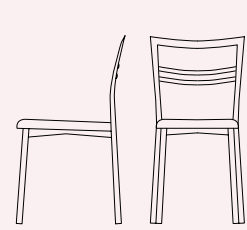

CB1419 | 42x47 H83 cm

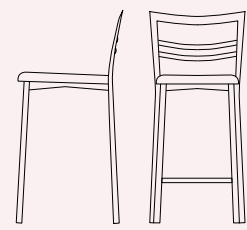

CB1513 | 43x49 H94 HS65 cm

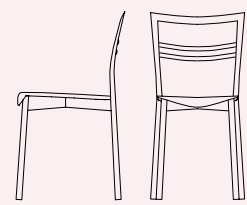

CB1690 | 42x47 H83 cm

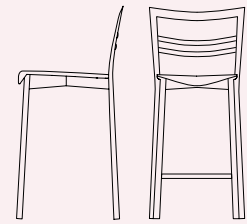

CB1689 | 43x49 H94 HS65 cm

## struttura frame

metallo | metal

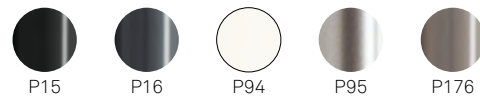

## sedile seat

legno | wood



PP



similpelle | faux leather



materiali sintetici |  
synthetic fabrics



sedie e sgabelli | chairs and stools



Go! CB1419 sedia | chair  
metallo P176 tortora opaco / polipropilene P900 tortora opaco  
metal P176 matt taupe / polypropylene P900 matt taupe

Go!

sedie e sgabelli | chairs and stools

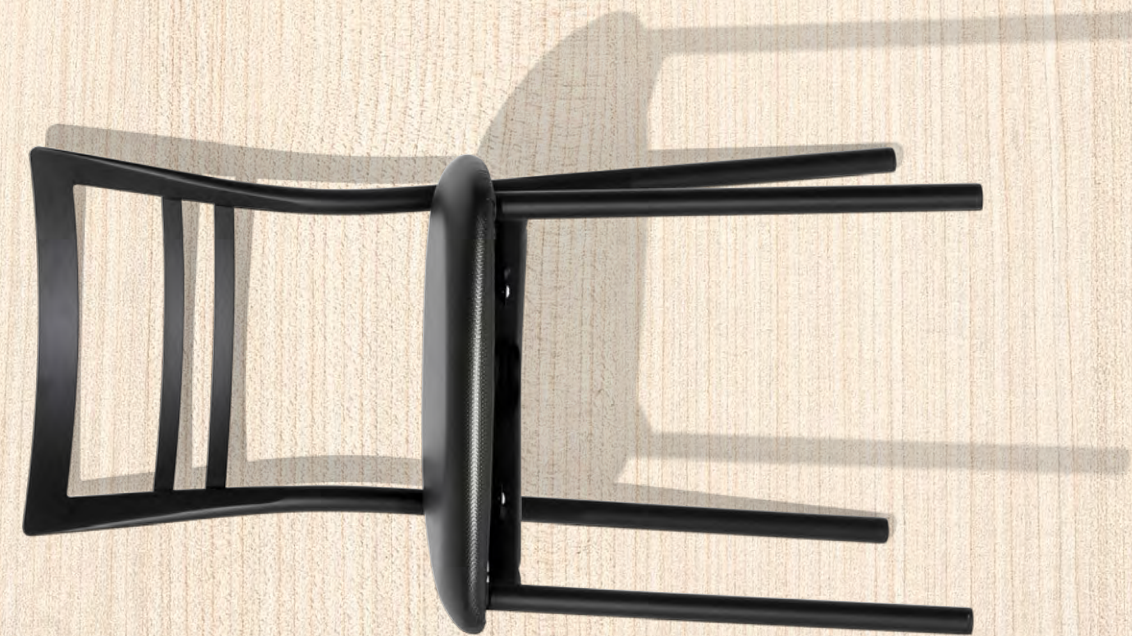
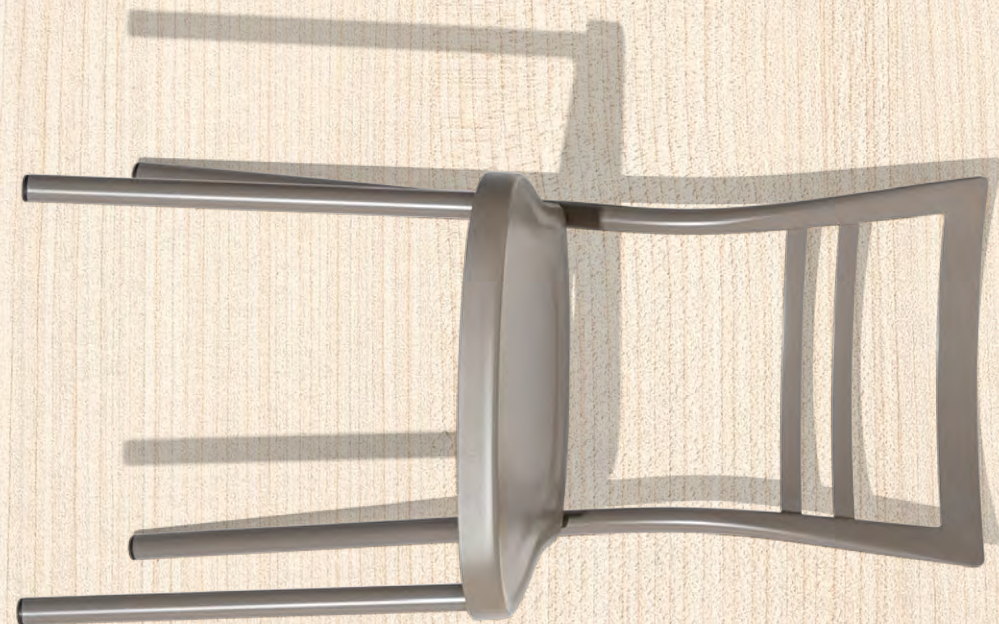

Go! sedie e sgabelli in metallo |  
metal chairs and stools  
**CB1419** | 176 tortora opaco /  
polipropilene P900 tortora opaco  
P176 matt taupe / polypropylene  
P900 matt taupe  
P15 nero opaco / materiale  
sintetico Carbon Look 481  
P15 matt black / Carbon Look  
synthetic fabric 481  
**CB1690** P94 bianco ottico  
opaco / multistrato rovere  
P19W rovere naturale  
P94 matt optic white / plywood  
oak P19W natural oak  
**CB1513** P15 nero opaco /  
similpelle Ekos G8N nero  
P15 matt black / Ekos  
faux leather G8N black  
**CB1689** P94 bianco ottico  
opaco / multistrato rovere  
P507 bianco ottico spazzolato  
P94 matt optic white / plywood  
oak P507 brushed optic white

# Gossip

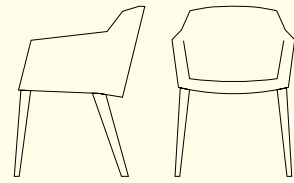

CB1110 | 57x61 H79,5 HB65 cm

## struttura frame

legno | wood

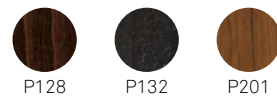

## sedile seat

tessuto | fabric



similpelle | faux leather



sedie e sgabelli | chairs and stools



**Gossip** CB1110 sedia | chair  
faggio P128 wengé / tessuto Berna 1SA3 sabbia  
beech P128 wenge / Berna fabric 1SA3 sand

NOTA per le combinazioni disponibili consultare il listino prezzi. | NOTE please check all available combinations in the price list.



# Helios

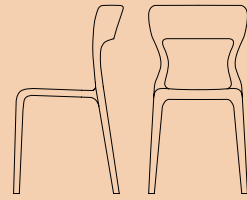

CB1312 | 44x52,5 H83 cm

## struttura/sedile frame/seat

PP



sedie e sgabelli | chairs and stools



**Helios CB1312**  
sedia in polipropilene | *polypropylene chair*  
P94 bianco ottico opaco | *P94 matt optic white*

Helios CB1312  
sedia in polipropilene | polypropylene chair  
P946 rosso opaco - P900 tortora opaco -  
P94 bianco ottico opaco - P16 grigio opaco  
P946 matt red - P900 matt taupe -  
P94 matt optic white - P16 matt grey



# Hexa

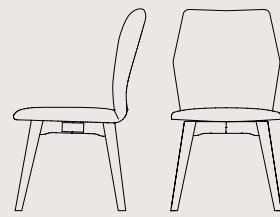

CB1936 | 51x59 H89 cm

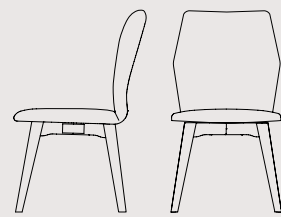

CB1937 | 51x59 H89 cm

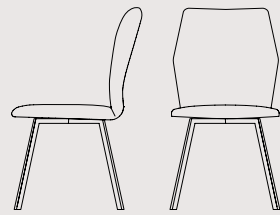

CB1977 | 51x59 H89 cm

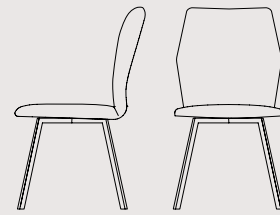

CB1938 | 51x59 H89 cm

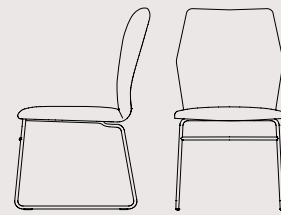

CB1934 | 49x59 H89 cm

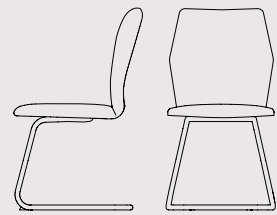

CB1935 | 50x58 H90 cm

## struttura frame

legno | wood

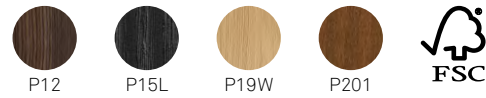

metallo | metal



## sedile seat

tessuto | fabric



similpelle | faux leather

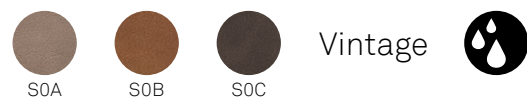

CB1937 | CB1938

RIVESTIMENTO IN STOFFA TRAPUNTATA NELLA SOLA PARTE POSTERIORE DELLO SCHIENALE, IMBOTTITURA SENZA TRAPUNTATURA NELLE VERSIONI VINTAGE E BEDFORD |  
QUILTED FABRIC COVER ONLY ON THE BACK, UPHOLSTERED WITH NO QUILTING FOR VINTAGE AND BEDFORD VERSIONS

NOTA per le combinazioni disponibili consultare il listino prezzi. | NOTE please check all available combinations in the price list.



Hexa CB1938 sedia | chair  
metallo P15 nero opaco / similpelle Vintage S0B tabacco  
metal P15 matt black / Vintage faux leather S0B tobacco

Hexa sedie in legno | *wooden chairs*  
**CB1936** | frassino P15L nero opaco / tessuto Berna 1SA3 sabbia  
*ashwood P15L matt black / Berna fabric 1SA3 sand*  
 frassino P19W rovere naturale / similpelle Vintage S0C ebano  
*ashwood P19W natural oak / Vintage faux leather S0C ebony*

Hexa sedie in metallo | *metal chairs*  
**CB1934** P15 nero opaco / tessuto Berna 1SA6 tortora  
*P15 matt black / Berna fabric 1SA6 taupe*  
**CB1977** P15 nero opaco / tessuto Berna 1SB2 fumo  
*P15 matt black / Berna fabric 1SB2 smoke grey*



# Ice

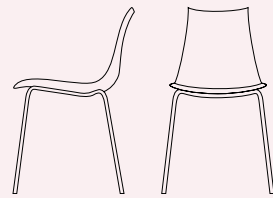

CB1038 | 47,5x53,5 H82 cm



CB1049  
41,5x42,5 H82,5 HS65 cm



CB1050  
41,5x42,5 H98 HS80 cm

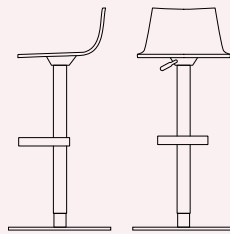

CB1039  
42,5x44 H97,5(78,5) HS84(65) cm

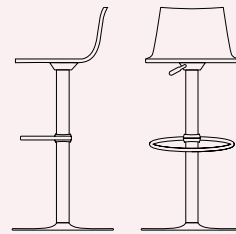

CB1475  
41,5x42,5 H98(76) HS80(58) cm

## struttura frame

metallo | metal

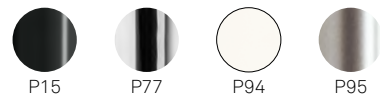

## sedile seat

SAN

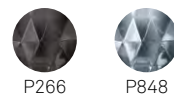

CB1039 | CB1475



CB1039 | CB1475

CB1049 | CB1050 FINITURA P95 CON BATTITACCO IN GOMMA NERA – FINITURA P77 SENZA BATTITACCO | P95 FINISH WITH BLACK RUBBER HEEL PAD – P77 FINISH WITHOUT HEEL PAD

NOTA per le combinazioni disponibili consultare il listino prezzi. | NOTE please check all available combinations in the price list.



Ice CB1038 sedia | chair  
metallo P77 cromato / tecnopolimero SAN P848 trasparente  
metal P77 chromed / technopolymer SAN P848 transparent



Ice CB1038 sedia | chair  
 metallo P77 cromato / tecnopolimero SAN P848 trasparente  
 metal P77 chromed / technopolymer SAN P848 transparent

Ice sgabelli in metallo | metal stools  
 CB1475 P15 nero opaco / tecnopolimero SAN P848 trasparente  
 P15 matt black / technopolymer SAN P848 transparent  
 CB1049 P77 cromato / tecnopolimero SAN P848 trasparente  
 P77 chromed / technopolymer SAN P848 transparent

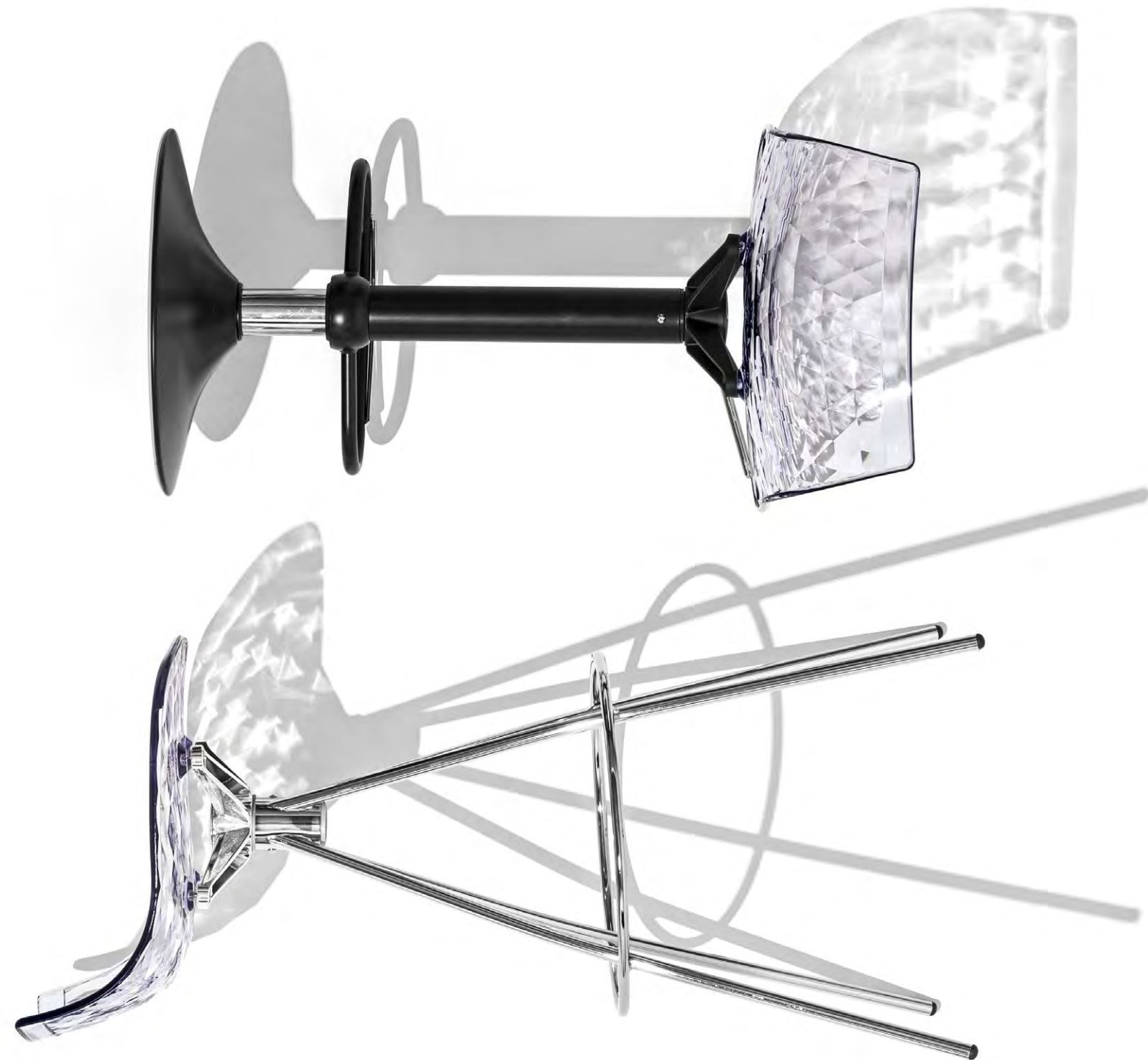

# Industrial

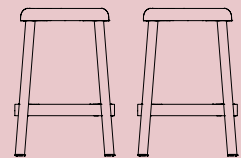

CB1957 | 44x44 H65 cm

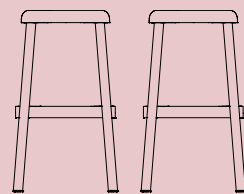

CB1958 | 46x46 H80 cm

## struttura/sedile frame/seat

metallo | metal



sedie e sgabelli | chairs and stools

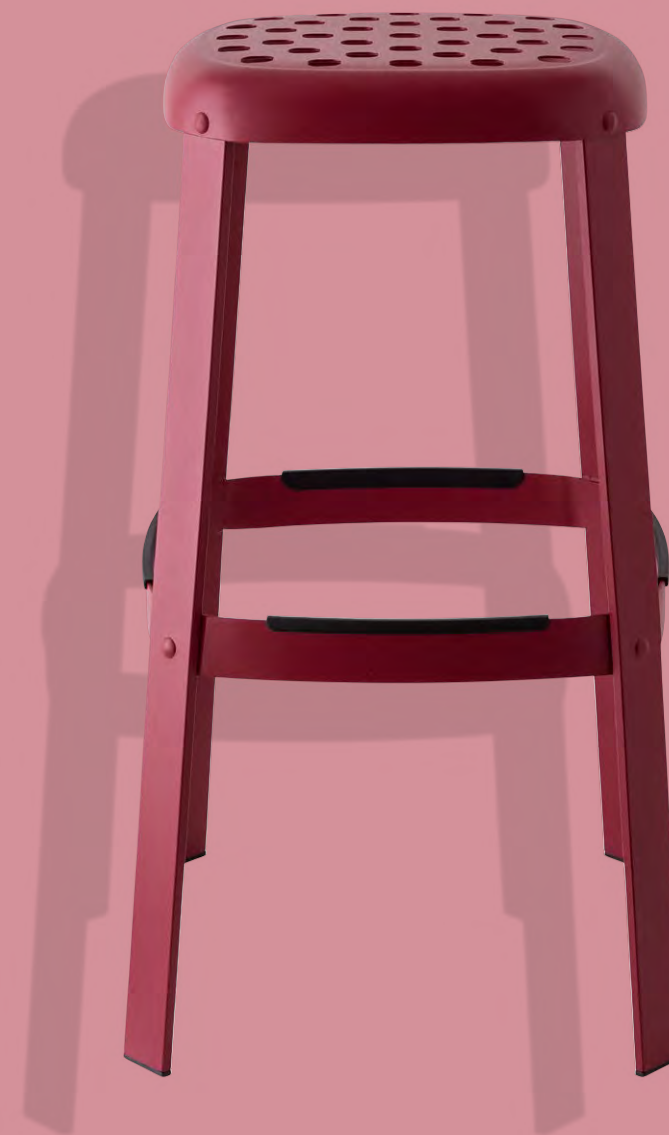

**Industrial** CB1958 sgabello | stool  
metallo P3L rosso ossido opaco  
metal P3L matt oxide red

Industrial

Industrial CB1958  
sgabello in metallo | *metal stool*  
P3L rosso ossido opaco | *P3L matt oxide red*



sedie e sgabelli | chairs and stools

Industrial CB1958  
sgabello in metallo | *metal stool*  
P3L rosso ossido opaco | *P3L matt oxide red*  
P15 nero opaco | *P15 matt black*





# Jam

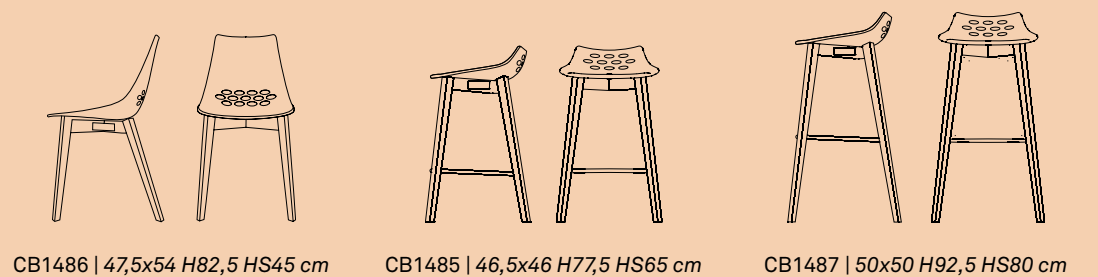

CB1486 | 47,5x54 H82,5 HS45 cm    CB1485 | 46,5x46 H77,5 HS65 cm    CB1487 | 50x50 H92,5 HS80 cm

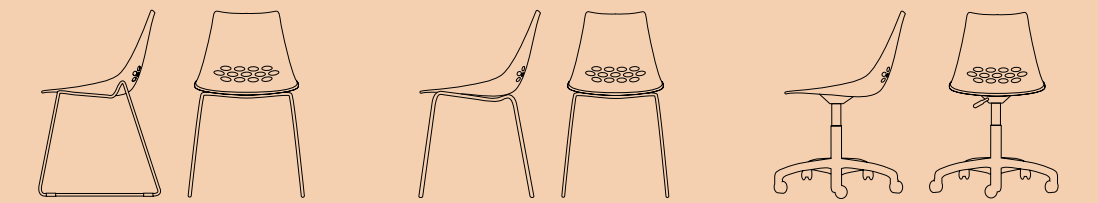

CB1030 | 51,5x54 H82,5 HS45 cm    CB1059 | 47,5x54 H82,5 HS45 cm    CB623 | 63x62 H90(81) HS53(44) cm

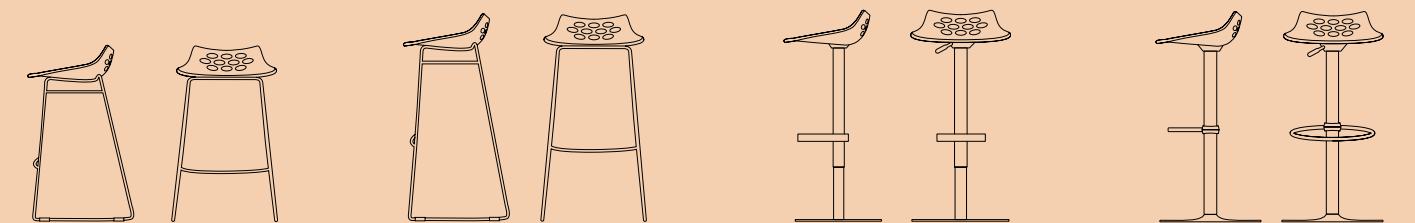

CB1033    CB1034    CB1035    CB1476  
48x51 H77,5 HS65 cm    48x51 H92,5 HS80 cm    44x43 H93(73,5) HS80(61) cm    44x43 H93(71) HS80(58) cm

## struttura frame

legno | wood

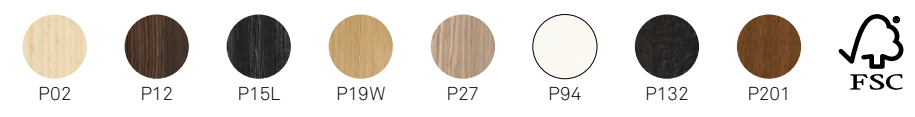

metallo | metal

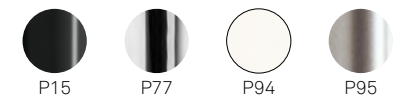

## sedile seat

ABS/PC

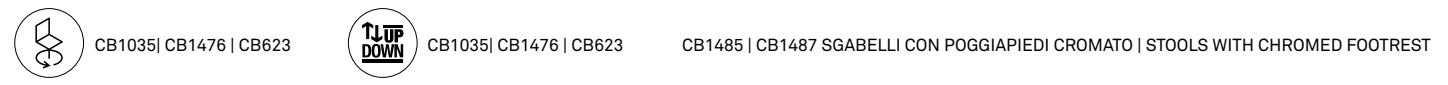

NOTA per le combinazioni disponibili consultare il listino prezzi. | NOTE please check all available combinations in the price list.



Jam CB1059 sedia | chair  
metallo P94 bianco ottico opaco / plastica bicolore P799-P848 bianco-trasparente  
metal P94 matt optic white / bicolor plastic P799-P848 white-transparent

**Jam**  
 sedie e sgabelli in metallo P77 cromato |  
*metal P77 chromed chairs and stools*  
**CB1033** P799-P851 bianco-arancio trasparente  
*P799-P851 white-transparent orange*  
**CB1035** P799-P848 bianco-trasparente  
*P799-P848 white-transparent*  
**CB1476** P799-P11P bianco-nocciola lucido  
*P799-P11P white-glossy nougat*  
**CB623** P799-P848 bianco-trasparente  
*P799-P848 white-transparent*  
**CB1030** P799-P13P bianco-senape lucido  
*P799-P13P white-glossy mustard yellow*  
**CB1059** P799-P837 bianco-tortora lucido  
*P799-P837 white-glossy taupe*







**Jam CB1486 sedia | chair**  
 faggio P02 faggio sbiancato / plastica bicolore P799 bianco-  
 P837 tortora lucido - P11P nocciola lucido - P13P senape lucido  
 beech P02 bleached beechwood / bicolor plastic P799 white-  
 P837 glossy taupe - P11P glossy nougat - P13P glossy mustard yellow



**Jam CB1486**  
 sedie in frassino e plastica bicolore |  
 ashwood and bicolor plastic chairs  
 P27 natural / P799-P11P  
 bianco-nocciola lucido  
 P27 natural / P799-P11P  
 white-glossy nougat  
 P15L nero opaco / P799-P837  
 bianco-tortora lucido  
 P15L matt black / P799-P837  
 white-glossy taupe  
**Jam CB1487**  
 sgabelli in faggio e plastica bicolore  
 beech and bicolor plastic stools  
 P02 faggio sbiancato / P799-P851  
 bianco-arancio trasparente -  
 P799-P837 bianco-tortora lucido  
 P02 bleached beechwood / P799-P851  
 white-transparent orange -  
 P799-P837 white-glossy taupe

# Jelly

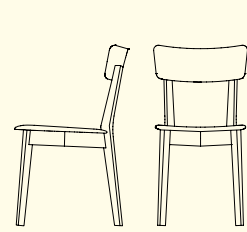

CB1528 | 42x51,5 H80 cm

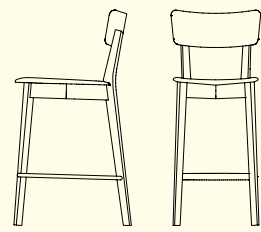

CB1529 | 43x52 H95 HS65 cm

## struttura frame

legno | wood



P02



P94



P132



## sedile seat

PP



P16



P94



P900



P973

SGABELLO CON POGGIPIEDI CROMATO | STOOL WITH CHROMED FOOTREST

NOTA per le combinazioni disponibili consultare il listino prezzi. | NOTE please check all available combinations in the price list.



Jelly CB1528 sedia | chair  
faggio P02 faggio sbiancato / polipropilene P94 bianco ottico opaco  
beech P02 bleached beechwood / polypropylene P94 matt optic white

Jelly sedie e sgabelli in faggio |  
 beech chairs and stools  
**CB1528** P02 faggio sbiancato /  
 polipropilene P94 bianco ottico opaco  
 P02 bleached beechwood /  
 polypropylene P94 matt optic white  
**CB1529** P02 faggio sbiancato /  
 polipropilene P94 bianco ottico opaco -  
 P900 tortora opaco - P973 senape opaco  
 P02 bleached beechwood /  
 polypropylene P94 matt optic white -  
 P900 matt taupe - P973 matt mustard yellow



# Jelly Metal

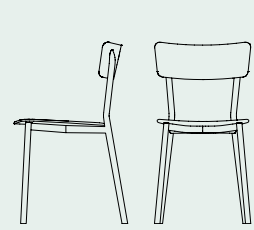

CB1954 | 42x50 H80 cm

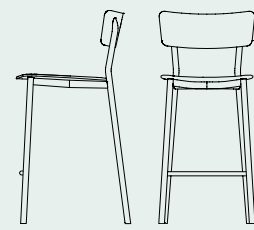

CB1969 | 43x51 H94 HS65 cm

## struttura frame

metallo | metal

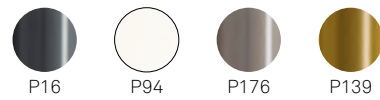

## sedile seat

PP

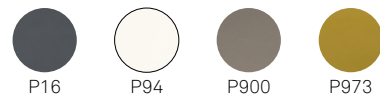

sedie e sgabelli | chairs and stools



Jelly Metal CB1954 sedia | chair  
metallo P176 tortora opaco / polipropilene P900 tortora opaco  
metal P176 matt taupe / polypropylene P900 matt taupe

NOTA per le combinazioni disponibili consultare il listino prezzi. | NOTE please check all available combinations in the price list.



**Jelly Metal** CB1954 sedia | chair  
metallo P176 tortora opaco / polipropilene P900 tortora opaco  
metal P176 matt taupe / polypropylene P900 matt taupe



**Jelly Metal** sedie e sgabello in metallo |  
metal chairs and stool  
**CB1954** P94 bianco ottico opaco /  
polipropilene P94 bianco ottico opaco  
P94 matt optic white /  
polypropylene P94 matt optic white  
P139 senape opaco /  
polipropilene P973 senape opaco  
P139 matt mustard yellow /  
polypropylene P973 matt mustard yellow  
**CB1969** P176 tortora opaco /  
polipropilene P900 tortora opaco  
P176 matt optic white /  
polypropylene P900 matt taupe



# Jenny

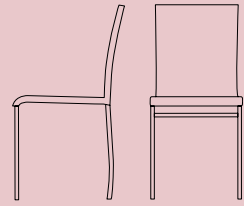

CB1362 | 42x54 H86 cm

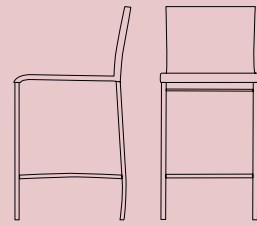

CB1219 | 44x56 H94 HS65 cm

## struttura frame

metallo | *metal*



P95

## sedile seat

materiali sintetici |  
*synthetic fabrics*



460



461



473



C6A

Net



CB1362

sedie e sgabelli | chairs and stools

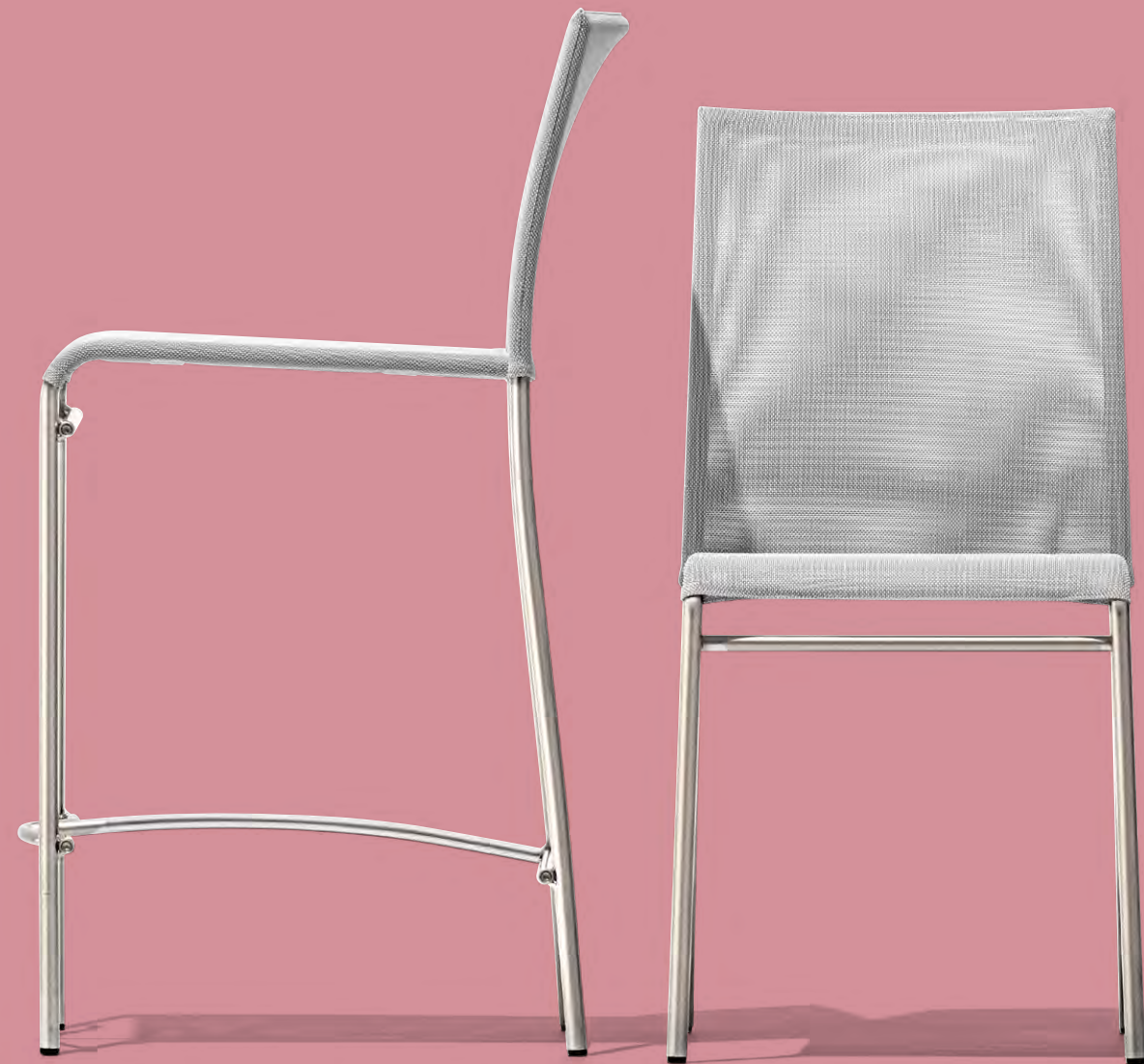

Jenny CB1362 sedia | *chair* / CB1219 sgabello | *stool*  
metallo P95 acciaio satinato / materiale sintetico Net 460 grigio  
*metal P95 satin finished steel / Net synthetic fabric 460 grey*

# Joe

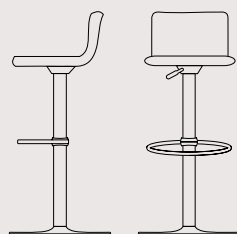

CB1532 | 40x47 H103(81) HS81,5(59,5) cm

## struttura frame

metallo | *metal*



P15



P77

## sedile seat

similpelle | *faux leather*



G8K



G8N



G8Q

Ekos



sedie e sgabelli | chairs and stools



Joe CB1532 sgabello | stool  
metallo P15 nero opaco / similpelle Ekos G8N nero  
metal P15 matt black / Ekos faux leather G8N black

# L'Eau

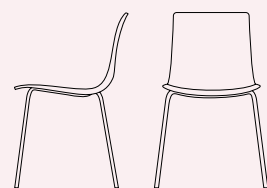

CB1273 | 55x55 H80 cm

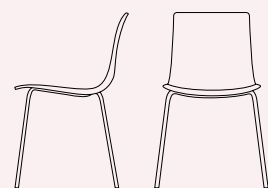

CB1273-N | 47,5x55 H80 cm



CB1269  
41,5x42,5 H84,5 HS65 cm



CB1270  
41,5x43,5 H98,5 HS80 cm

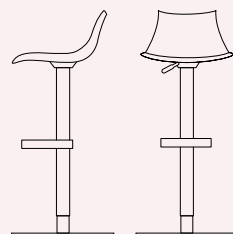

CB1288  
42,5x45 H99,5(80,5) HS84(65) cm

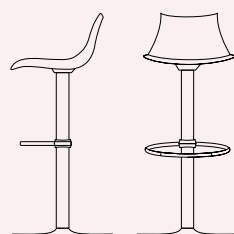

CB1477  
42,5x45 H98(76) HS80(58) cm

## struttura frame

metallo | metal

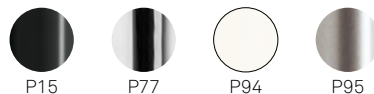

## sedile seat

SAN

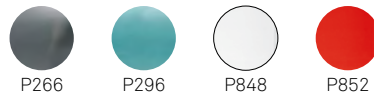

CB1273



CB1288 | CB1477



CB1288 | CB1477

CB1269 | CB1270 FINITURA P95 CON BATTITACCO IN GOMMA NERA – FINITURA P77 SENZA BATTITACCO | P95 FINISH WITH BLACK RUBBER HEEL PAD – P77 FINISH WITHOUT HEEL PAD

NOTA per le combinazioni disponibili consultare il listino prezzi. | NOTE please check all available combinations in the price list.



L'Eau CB1273-N sedia | chair  
metallo P77 cromato / tecnopolimero trasparente SAN P296 verde acqua  
metal P77 chromed / transparent technopolymer SAN P296 aquamarine



L'Eau sedie in metallo e tecnopolimero trasparente SAN |  
 metal and transparent technopolymer SAN chairs  
 CB1273 P77 cromato / P266 grigio fumè -  
 P296 verde acqua trasparente - P848 trasparente  
 P77 chromed / P266 smoke grey - P296 aquamarine - P848 transparent

L'Eau sedie e sgabelli in metallo e  
 tecnopolimero trasparente SAN |  
 metal and transparent  
 technopolymer SAN chairs and stools  
 CB1273 P77 cromato /  
 P266 grigio fumè - P852 rosso  
 P77 chromed / P266 smoke grey / P852 red  
 CB1269 P95 acciaio satinato / P296 verde acqua  
 P95 satin finished steel / P296 aquamarine  
 CB1288 P77 cromato / P848 trasparente  
 P77 chromed / P848 transparent

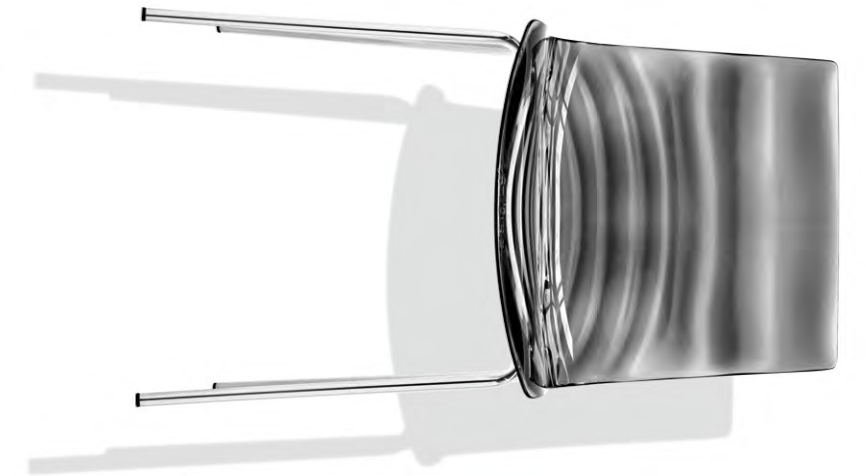

# Led

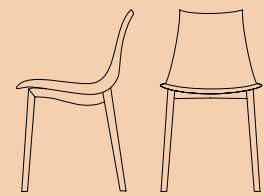

CB1507 | 49x54 H81 cm

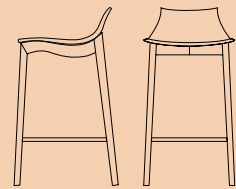

CB1541 | 44x46 H78,5 HS65 cm

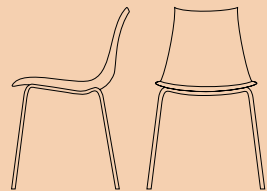

CB1298 | 51x53 H80 cm

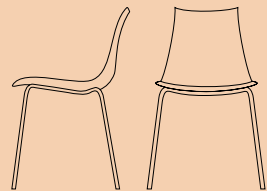

CB1298-N | 47x53 H80 cm

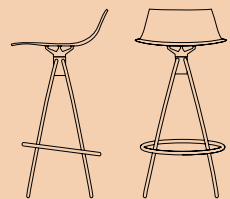

CB1427  
41,5x42,5 H83 HS67 cm



CB1428  
41,5x42,5 H98 HS82 cm

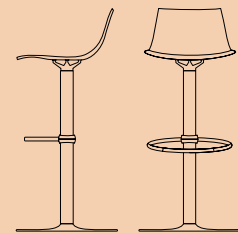

CB1405  
41,5x42,5 H98(76) HS80(58) cm

## struttura frame

legno | wood



P02



P94

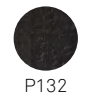

P132



P201



FSC

metallo | metal



P15

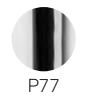

P77



P94

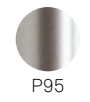

P95

## sedile seat

SAN

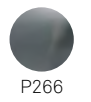

P266



P296



P799



P848

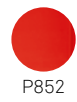

P852



CB1298



CB1405



CB1405

CB1541 SGABELLO CON POGGIAPIEDI CROMATO | STOOL WITH CHROMED FOOTREST  
CB1427 | CB1428 FINITURA P95 CON BATTITACCO IN GOMMA NERA - FINITURA P77 SENZA BATTITACCO |  
P95 FINISH WITH BLACK RUBBER HEEL PAD - P77 FINISH WITHOUT HEEL PAD

NOTA per le combinazioni disponibili consultare il listino prezzi. | NOTE please check all available combinations in the price list.



Led CB1298-N sedia | chair  
metallo P94 bianco ottico opaco / tecnopolimero coprente SAN P799 bianco ottico lucido  
metal P94 matt optic white / solid colour technopolymer SAN P799 glossy optic white



Led sedie in metallo e tecnopolimero trasparente SAN |  
*metal and transparent technopolymer SAN chairs*  
**CB1298** P77 cromato / P852 rosso - P296 verde acqua -  
 P266 grigio fumè - P848 trasparente  
*P77 chromed / P852 red - P296 aquamarine -  
 P266 smoke grey - P848 transparent*

Led CB1405 | CB1427 | CB1428  
 sgabelli in metallo e tecnopolimero coprente SAN |  
*metal and solid colour technopolymer SAN stools*  
 P77 cromato / P799 bianco ottico lucido  
*P77 chromed / P799 glossy optic white*



Led

Led sedie e sgabello in faggio e tecnopolimero trasparente o coprente SAN | beech and transparent or solid colour technopolymer SAN chairs and stool  
CB1507 P02 faggio sbiancato / P266 grigio fumè - P296 verde acqua - P852 rosso  
P02 bleached beechwood / P266 smoke grey - P296 aquamarine - P852 red  
P94 bianco ottico opaco / P799 bianco ottico lucido  
P94 matt optic white / P799 glossy optic white  
CB1541 P132 grafite / P296 verde acqua  
P132 graphite / P296 aquamarine



sedie e sgabelli | chairs and stools



# Maya

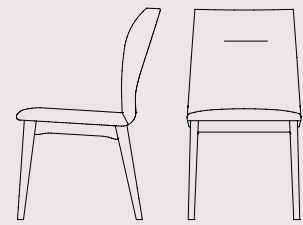

CB1914 | 51x61 H92 cm

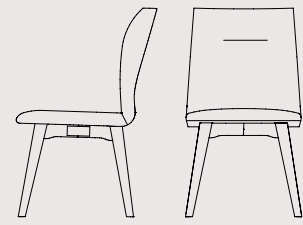

CB1926 | 51x61 H92 cm

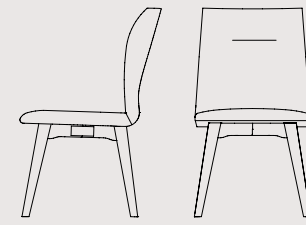

CB1919 | 51x61 H92 cm

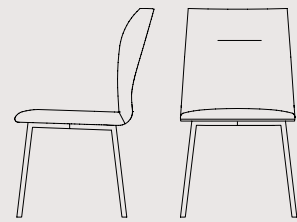

CB1976 | 51x61 H92 cm

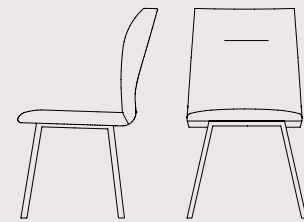

CB1927 | 51x61 H92 cm

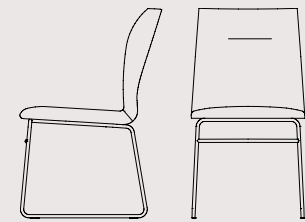

CB1913 | 51x61 H92 cm

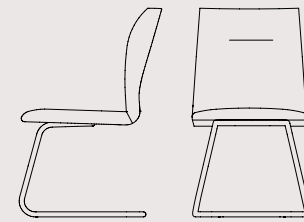

CB1925 | 51x60 H93 cm

## struttura frame

legno | wood

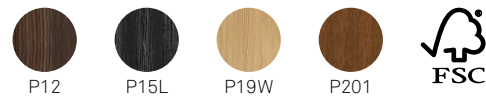

metallo | metal

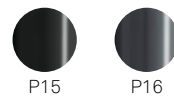

## sedile seat

tessuto | fabric

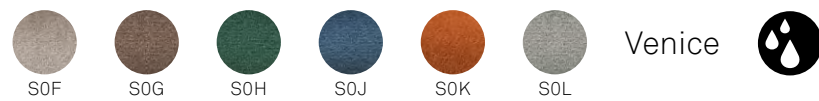

similpelle | faux leather



CB1919 | CB1927

NOTA per le combinazioni disponibili consultare il listino prezzi. | NOTE please check all available combinations in the price list.



Maya CB1926 sedia | chair  
frassino P12 smoke / tessuto Venice S0L cenere  
ashwood P12 smoke / Venice fabric S0L ash grey



**Maya** sedie | chairs  
**CB1914** frassino P19W rovere naturale /  
 tessuto Venice S0F sabbia  
*ashwood P19W natural oak /*  
*Venice fabric S0F sand*  
**CB1919** frassino P12 smoke /  
 tessuto Venice S0K mattone  
*ashwood P12 smoke /*  
*Venice fabric S0K brick red*  
**CB1927** metallo P15 nero opaco /  
 tessuto Venice S0H bosco  
*metal P15 matt black /*  
*Venice fabric S0H forest green*  
**CB1913** metallo P15 nero opaco /  
 similpelle Vintage S0A deserto  
*metal P15 matt black /*  
*Vintage faux leather S0A desert*



# Milano

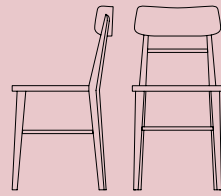

CB1284 | 43x47 H81 cm

**struttura/sedile**  
*frame/seat*

legno | wood



sedie e sgabelli | chairs and stools



**Milano CB1284 sedia | chair**  
faggio P02 faggio sbiancato / multistrato faggio P02 faggio sbiancato  
beech P02 bleached beechwood / plywood beech P02 bleached beechwood

# New York

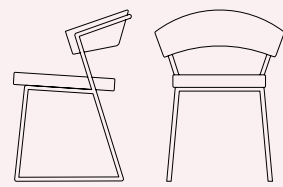

CB1022  
57x52 H75,5 HS45 HB64 cm

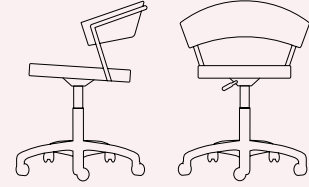

CB624  
63x65 H87(78) HS54(45) HB 64(55) cm

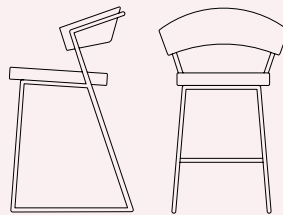

CB1087  
57x55 H91 HS65 cm

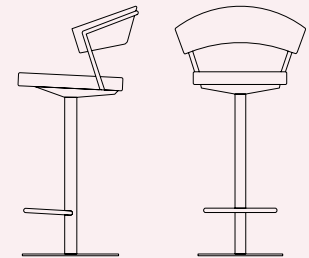

CB1088  
57x53 H110(97) HS80(66) cm

## struttura frame

metallo | metal

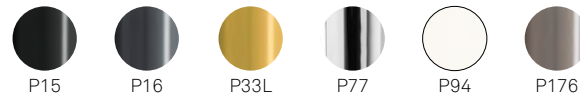

## sedile seat

tessuto | fabric

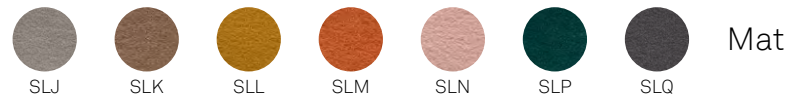

similpelle | faux leather



pelle | soft leather

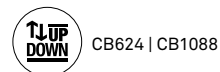
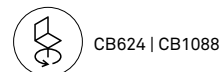

NOTA per le combinazioni disponibili consultare il listino prezzi. | NOTE please check all available combinations in the price list.



New York CB1022 sedia | chair  
metallo P94 bianco ottico opaco / similpelle Bedford SLY sale  
metal P94 matt optic white / Bedford faux leather SLY salt white

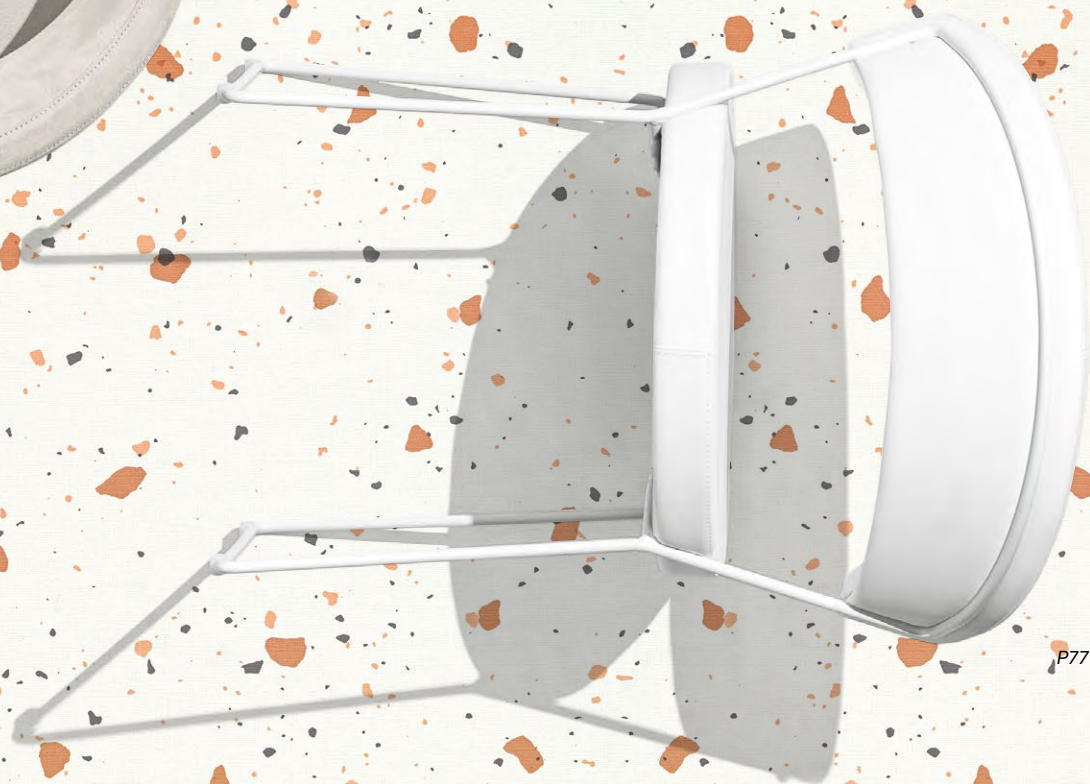
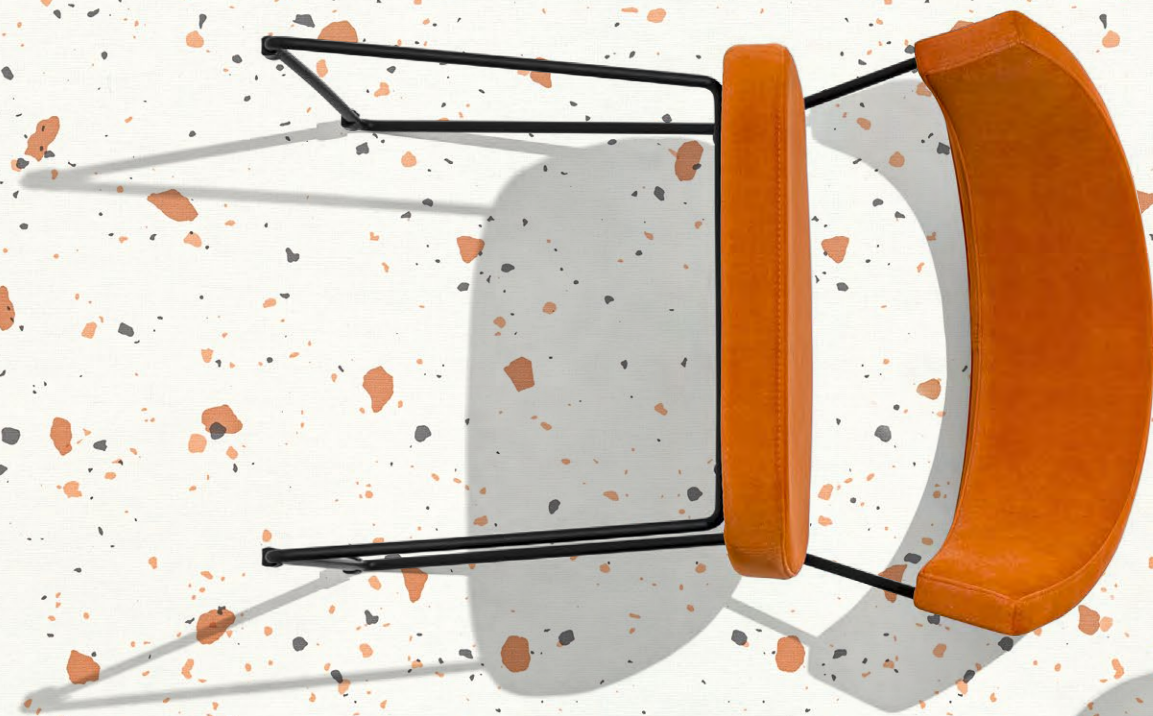

- New York CB1022  
sedie in metallo | metal chairs  
P16 grigio opaco / similpelle  
Vintage SOC ebano  
P16 matt grey / Vintage  
faux leather SOC ebony  
P15 nero opaco / tessuto  
Mat SLM zafferano  
P15 matt black / Mat fabric  
SLM saffron yellow  
P94 bianco ottico opaco /  
similpelle Bedford SLY sale  
P94 matt optic white / Bedford  
faux leather SLY salt white  
P77 cromato / pelle D04 tortora  
P94 bianco ottico opaco /  
pelle 705 bianco ottico  
P94 matt optic white /  
soft leather 705 optic white

**New York CB1022**  
sedie in metallo | *metal chairs*  
metallo P33L ottone verniciato /  
tessuto Mat SLQ grigio - SLP bosco -  
SLJ sabbia - SLL limone - SLN rosa  
*metal P33L Painted Brass /*  
*Mat fabric SLQ grey - SLP forest green -*  
*SLJ sand - SLL lemon yellow - SLN pink*





**New York CB624** sedia home office | *home office chairs*  
metallo P77 cromato / similpelle Ekos G8K bianco ottico  
*metal P77 chromed / Ekos faux leather G8K optic white*

**New York** sgabelli in metallo | *metal stools*  
**CB1087** P15 nero opaco / pelle 683 nero  
*P15 matt black / soft leather 683 Black*  
P15 nero opaco / pelle D04 tortora  
*P15 matt black / soft leather D04 taupe*  
**CB1088** P15 nero opaco / similpelle Vintage S0A deserto  
*P15 matt black / Vintage soft leather S0A desert*



# Nova

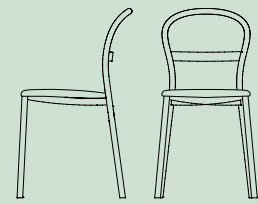

CB1669 | 42x47 H83,5 cm

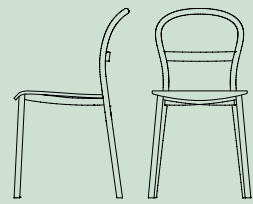

CB1666 | 41,5x47 H83,5 cm

sedie e sgabelli | chairs and stools



## struttura frame

metallo | metal

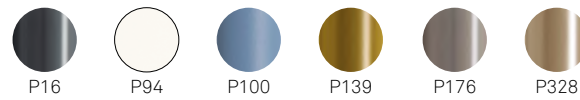

## sedile seat

legno | wood



PP



similpelle | faux leather



materiali sintetici |  
synthetic fabrics



NOTA per le combinazioni disponibili consultare il listino prezzi. | NOTE please check all available combinations in the price list.

Nova CB1666 sedia | chair  
metallo P94 bianco ottico opaco / multistrato rovere P507 bianco ottico spazzolato  
metal P94 matt optic white / plywood oak P507 brushed optic white

# Robinson

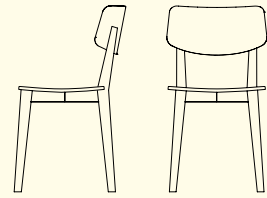

CB1436 | 43,5x52,5 H82 cm

**struttura/sedile**  
*frame/seat*

legno | wood

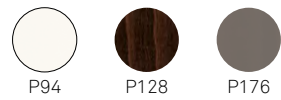

sedie e sgabelli | chairs and stools



**Robinson** CB1436 sedia | *chair*  
faggio P176 tortora opaco / multistrato faggio P176 tortora opaco  
beech P176 matt taupe / plywood beech P176 matt taupe



# Robinson Soft

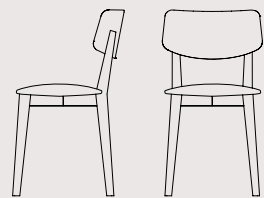

CB1436-S | 45x52,5 H82 cm

## struttura frame

legno | wood

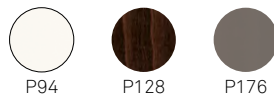

## sedile seat

tessuto | fabric



similpelle | faux leather



NOTA per le combinazioni disponibili consultare il listino prezzi. | NOTE please check all available combinations in the price list.



Robinson Soft CB1436-S sedia | chair  
faggio P176 tortora opaco / tessuto Berna 1SA6 tortora  
beech P176 matt taupe / Berna fabric 1SA6 taupe

# Rocket

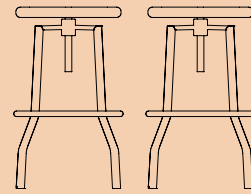

CB1960 | Ø40 H81(66) cm

## struttura frame

metallo | metal



P15

## sedile seat

legno | wood



P19W

similpelle | faux leather



S0A



S0B



S0C

Vintage



materiali sintetici |  
synthetic fabrics



481

Carbon Look



Rocket CB1960 sgabelli | stools  
metallo P15 nero opaco / materiale sintetico Carbon Look 481 - frassino P19W rovere naturale  
metal P15 matt black / Carbon Look synthetic fabric 481 - ashwood P19W natural oak

# Rosie Soft

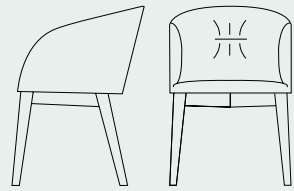

CB1910 | 55x59 H79 HB67 cm

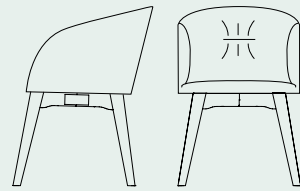

CB1922 | 55x59 H79 HB67 cm

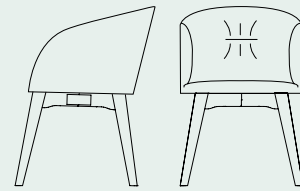

CB1923 | 55x59 H79 HB67 cm

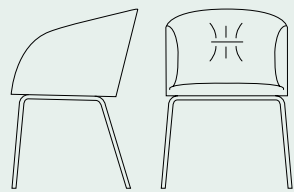

CB1901 | 55x59 H79 HB67 cm

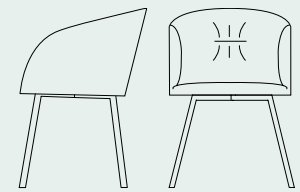

CB1924 | 55x59 H79 HB67 cm

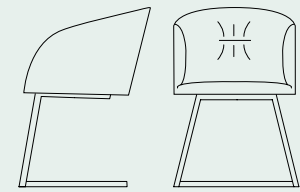

CB1921 | 55x59 H78 HB67 cm

## struttura frame

legno | wood

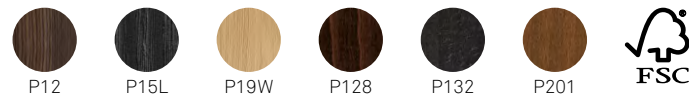

metallo | metal

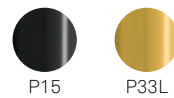

## sedile seat

tessuto | fabric

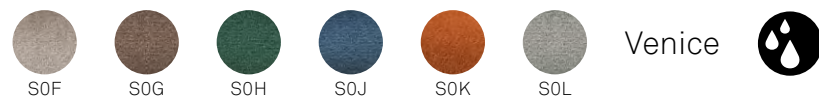

similpelle | faux leather



CB1923 | CB1924

NOTA per le combinazioni disponibili consultare il listino prezzi. | NOTE please check all available combinations in the price list.



Rosie Soft CB1901 sedia | chair  
metallo P33L ottone verniciato / tessuto Venice S0K mattone  
metal P33L Painted Brass / Venice fabric S0K brick red

**Rosie Soft**

sedie in metallo | *metal chairs*  
**CB1921** P15 nero opaco /  
 tessuto Venice S0J oceano  
*P15 matt black / Venice fabric*  
*S0J ocean blue*  
**CB1924** P15 nero opaco /  
 similpelle Vintage S0A deserto  
*P15 matt black / Vintage faux*  
*leather S0A desert*  
**CB1901** P15 nero opaco /  
 similpelle Vintage S0C ebano  
*P15 matt black / Vintage faux*  
*leather S0C ebony*

**Rosie Soft**

sedie in legno | *wooden chairs*  
**CB1923** frassino P19W rovere  
 naturale / tessuto Venice S0L cenere /  
*ashwood P19W natural oak /*  
*Venice fabric S0L ash grey*  
**CB1910** faggio P132 grafite /  
 similpelle Vintage S0A deserto  
*beech P132 graphite /*  
*Vintage faux leather S0A desert*

# Sami

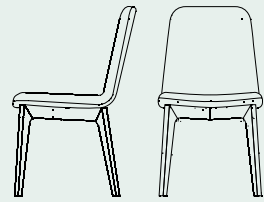

CB1472 | 48x53 H83,5 cm

## struttura frame

legno | wood



## sedile seat

tessuto | fabric

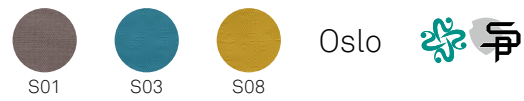

sedie e sgabelli | chairs and stools



Sami CB1472 sedia | chair  
frassino P27 natural / tessuto Oslo S03 acquamarina  
ashwood P27 natural / Berna fabric S03 aquamarine

# Sandy

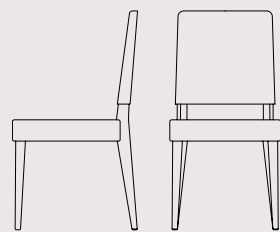

CB1260 | 48,5x55,5 H96,5 cm

## struttura frame

legno | wood



P128



P132



P201



FSC

## sedile seat

tessuto | fabric



1SA3



1SA6



1SB2

Berna



similpelle | faux leather



G8K



G8N



G8Q

Ekos



sedie e sgabelli | chairs and stools



Sandy CB1260 sedia | chair  
faggio P128 wengé / similpelle Ekos G8Q tortora  
beech P128 wenge / Ekos faux leather G8Q taupe

NOTA per le combinazioni disponibili consultare il listino prezzi. | NOTE please check all available combinations in the price list.

# Sibilla

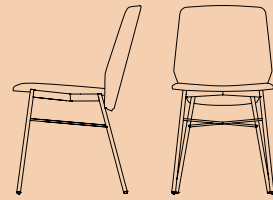

CB1959 | 45x56 H83 cm

## struttura frame

metallo | *metal*

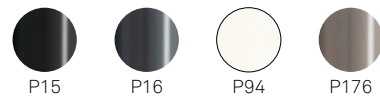

## sedile seat

rig. cuoio | *reg. leather*



sedie e sgabelli | chairs and stools



Sibilla CB1959 sedia | chair  
metallo P15 nero opaco / rigenerato di cuoio 315 nero  
metal P15 matt black / regenerated leather 315 black

NOTA per le combinazioni disponibili consultare il listino prezzi. | NOTE please check all available combinations in the price list.

Sibilla CB1959  
sedie in metallo e rigenerato di cuoio |  
metal and regenerated leather chairs  
P176 tortora opaco / D03 tortora  
P176 matt taupe / D03 taupe  
P16 grigio opaco / R16 grigio  
P16 matt grey / R16 grey  
P15 nero opaco / 315 nero  
P15 matt black / 315 black  
P15 nero opaco / R04 cognac  
P15 matt black / R04 cognac





# Siren

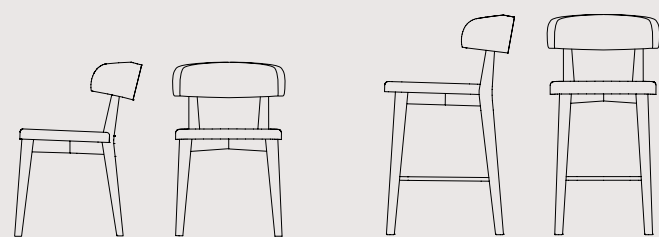

CB1536 | 52x56 H77 cm

CB1542 | 51x55 H98 HS65 cm

sedie e sgabelli | chairs and stools



## struttura frame

legno | wood

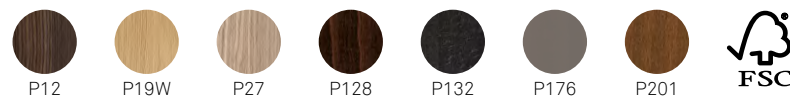

## sedile seat

tessuto | fabric



similpelle | faux leather

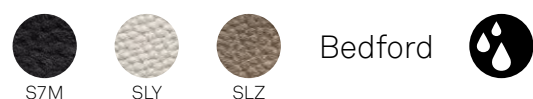

SGABELLO CON POGGIPIEDI CROMATO | STOOL WITH CHROMED FOOTREST

Siren CB1536 sedia | chair  
faggio P128 wengé / similpelle Bedford SLZ fango  
beech P128 wenge / Bedford faux leather SLZ mud brown

NOTA per le combinazioni disponibili consultare il listino prezzi. | NOTE please check all available combinations in the price list.



**Siren CB1536 sedia | chair**  
 faggio P132 grafite / similpelle Ekos G8K bianco  
 beech P132 graphite / Ekos faux leather G8K white



**Siren**  
**CB1536 sedia | chair**  
 faggio P128 wengé / tessuto Berna 1SB2 fumo  
 beech P128 wenge / Berna fabric 1SB2 smoke grey  
**CB1542 sgabello | stool**  
 faggio P128 wengé / similpelle Ekos G8K bianco  
 beech P128 wenge / Ekos faux leather G8K white

# Snack

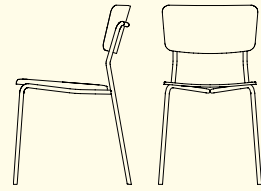

CB1956 | 46x53 H79 cm

## struttura frame

metallo | metal



## sedile seat

legno | wood



sedie e sgabelli | chairs and stools



Snack CB1956 sedia | chair  
metallo P15 nero opaco / multistrato frassino P19W rovere naturale  
metal P15 matt black / plywood ashwood P19W natural oak

NOTA per le combinazioni disponibili consultare il listino prezzi. | NOTE please check all available combinations in the price list.



**Snack CB1956 sedia | chair**  
 metallo P15 nero opaco / multistrato frassino P19W rovere naturale  
 metal P15 matt black / plywood ashwood P19W natural oak

**Snack CB1956**  
 sedia in metallo e multistrato di frassino |  
 metal and plywood ashwood chair  
 P94 bianco ottico opaco / P507 bianco ottico spazzolato  
 P94 matt optic white / P507 brushed optic white  
 P94 bianco ottico opaco / P19W rovere naturale  
 P94 matt optic white / P19W natural oak  
 P15 nero opaco / P15L nero opaco  
 P15 matt black / P15L matt black  
 P16 grigio opaco / P16 grigio opaco  
 P16 matt grey / P16 matt grey



# Sonora

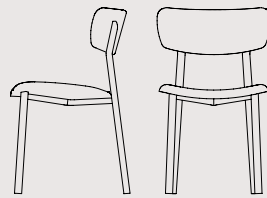

CB1973 | 49x55 H82 cm

## struttura frame

metallo | *metal*



## sedile seat

tessuto | *fabric*



similpelle | *faux leather*



sedie e sgabelli | chairs and stools



Sonora CB1973 sedia | *chair*  
metallo P176 tortora opaco / tessuto Berna 1SA6 tortora  
*metal P176 matt taupe / Berna fabric 1SA6 taupe*

NOTA per le combinazioni disponibili consultare il listino prezzi. | *NOTE please check all available combinations in the price list.*

# Up!

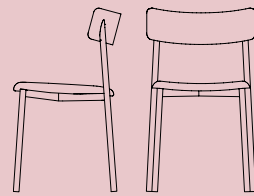

CB1955 | 49x48 H81 cm

## struttura frame

metallo | *metal*

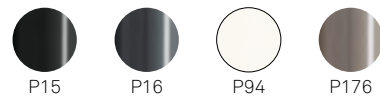

## sedile seat

similpelle | *faux leather*

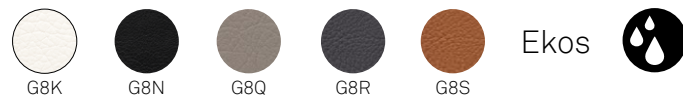

sedie e sgabelli | chairs and stools



Up! CB1955 sedia | *chair*  
metallo P94 bianco ottico opaco / similpelle Ekos G8K bianco  
*metal P94 matt optic white / Ekos faux leather G8K white*

NOTA per le combinazioni disponibili consultare il listino prezzi. | *NOTE please check all available combinations in the price list.*



Up! CB1955 sedia | chair  
 metallo P94 bianco ottico opaco / similpelle Ekos G8K bianco  
 metal P94 matt optic white / Ekos faux leather G8K white



Up! CB1955  
 sedie in metallo e rivestimento in similpelle |  
 metal chairs with faux leather upholstery |  
 P176 tortora opaco / Ekos G8Q tortora  
 P176 matt taupe / Ekos G8Q taupe  
 P15 nero opaco / Ekos G8S cognac  
 P15 matt black / Ekos G8S cognac  
 P16 grigio opaco / Ekos G8R grigio  
 P16 matt grey / Ekos G8R grey  
 P15 nero opaco / Ekos G8N nero  
 P15 matt black / Ekos G8N black

# Alu

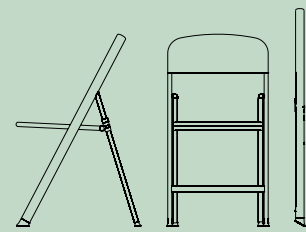

CB205 | 45x55(4,5) H85(96) cm

## struttura frame

alluminio | *aluminium*



P83

## sedile seat

materiali sintetici |  
*synthetic fabrics*



Net

460

FLAT CB5073

gancio da fissare a muro con tasselli  
per appendere n. 4 sedie Alu  
*to be fitted with dowels to the wall  
to hold n. 4 Alu chairs*



sedie pieghevoli | *folding chairs*



**Alu** CB205 sedia | *chair*  
alluminio P83 alluminio satinato / materiale sintetico Net 460 grigio  
*aluminium P83 satin fin. aluminium / Net synthetic fabric 460 grey*



# Olivia

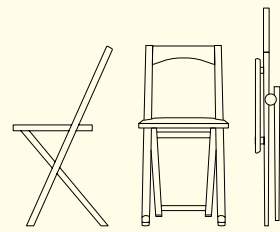

CB208 | 38,5x48(4) H80(96) cm

## struttura/sedile frame/seat

legno | wood

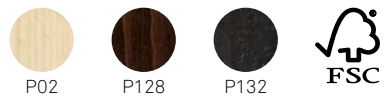

HOOK CB508  
gancio da fissare a muro con tasselli  
per appendere n. 4 sedie Olivia  
*to be fitted with dowels to the wall  
to hold n. 4 Olivia chairs*



## struttura frame

metallo | metal



sedie pieghevoli | folding chairs



**Olivia CB208 sedia | chair**  
faggio P02 faggio sbiancato / faggio P02 faggio sbiancato  
beech P02 bleached beechwood / beech P02 bleached beechwood

# Skip

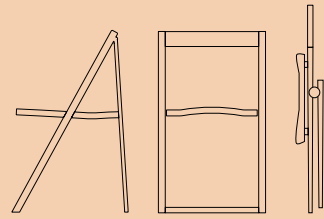

CB207 | 47x51(5) H80(91) cm

sedie pieghevoli | folding chairs

## struttura frame

alluminio | *aluminium*



P83

## struttura/sedile frame/seat

legno | *wood*



P94



P128



P176



P201

FLAT CB5073

gancio da fissare a muro con tasselli  
per appendere n. 4 sedie Skip  
*to be fitted with dowels to the wall  
to hold n. 4 Skip chairs*



## struttura frame

metallo | *metal*



P95



**Skip** CB207 sedia | *chair*  
faggio P201 noce - alluminio P83 alluminio satinato / multistrato faggio P201 noce  
*beech P201 walnut - aluminium P83 satin fin. aluminium / plywood beech P201 walnut*

# tavoli | *tables*

tavoli allungabili | extending tables | tavoli  
fissi | non-extending tables | tavoli pieghevoli  
e consolle | folding tables and consoles |  
tavoli contract | contract tables | tavolini  
trasformabili | multi-purpose tables | tavolini  
fissi | coffee tables | specchi | mirrors

# Airport

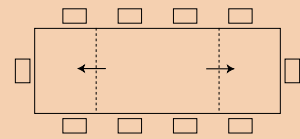
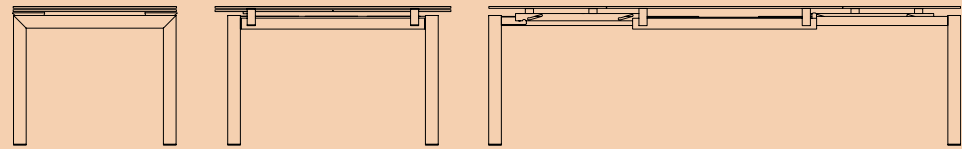

CB4011-R 130 | 130(195-260)x90 cm

## gambe/cassonetto legs/frame

metallo | metal

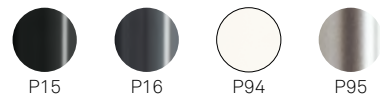

## piano top

ceramica | ceramic



vetro | glass



NOTA per le combinazioni disponibili consultare il listino prezzi. | NOTE please check all available combinations in the price list.

tavoli fissi e allungabili | extending and non-extending tables



Airport CB4011-R 130 tavolo allungabile | extending table  
metallo P16 grigio opaco / ceramica P1C cemento  
metal P16 matt grey / ceramic P1C cement

Airport

MAGIC  
x-tension

ALLUNGA AUTOMATICA tavolo allungabile con meccanismo automatico; le allunghe si posizionano autonomamente all'altezza del piano principale.  
AUTOMATIC EXTENSION extendable table with automatic mechanism; the extensions will automatically align with the top.



Airport CB4011-R 130 tavolo allungabile | *extending table*  
metallo P94 bianco ottico opaco / ceramica P166 nocciola  
metal P94 matt optic white / ceramic P166 nougat

tavoli fissi e allungabili | *extending and non-extending tables*

Airport CB4011-R 130 tavolo allungabile | *extending table*  
metallo P15 nero opaco / ceramica P5C sale  
metal P15 matt black / ceramic P5C salt white



Airport CB4011-R 130 tavolo allungabile | *extending table*  
metallo P15 nero opaco / ceramica P5C sale  
*metal P15 matt black / ceramic P5C salt white*  
New York CB1022 sedia | *chair*  
metallo P15 nero opaco / tessuto Mat SLK cammello  
*metal P15 matt black / Mat fabric SLK camel brown*



# Aladino

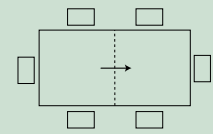
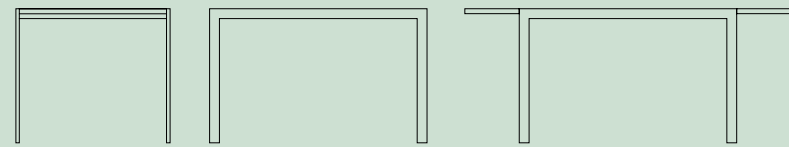

CB4742-Q 80 | 80(160)x80 cm

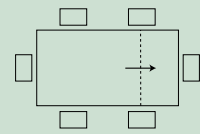

CB4742-R 110 | 110(150)x70 cm

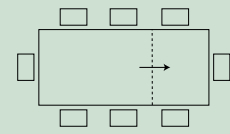

CB4742-R 120 | 120(180)x85 cm

## gambe legs

metallo | metal

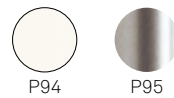

## piano top

nobilitato | melamine

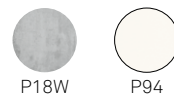

NOTA per le combinazioni disponibili consultare il listino prezzi. | NOTE please check all available combinations in the price list.

## tavoli fissi e allungabili | extending and non-extending tables

**Aladino** CB4742-R tavolo allungabile | *extending table*  
 metallo P94 bianco ottico opaco / nobilitato P18W beton grigio  
 metal P94 matt optic white / melamine P18W beton grey  
**Alchemia** CB1056 sedia | *chair*  
 polipropilene P94 bianco ottico opaco  
 polypropylene P94 matt optic white



## Aladino

EASY  
x-tension

ALLUNGA SEMI-AUTOMATICA tavolo allungabile con meccanismo semi automatico; le allunghe vengono posizionate agevolmente traslando su apposite guide.  
SEMI-AUTOMATIC EXTENSION extendable table with semi-automatic mechanism; the extensions are easily aligned with the top by gliding on special runners.



Aladino CB4742-R tavolo allungabile | *extending table*  
metallo P94 bianco ottico opaco / nobilitato P94 bianco ottico opaco  
metal P94 matt optic white / melamine P94 matt optic white

## tavoli fissi e allungabili | *extending and non-extending tables*

Aladino CB4742-R tavolo allungabile | *extending table*  
metallo P94 bianco ottico opaco / nobilitato P18W beton grigio  
metal P94 matt optic white / melamine P18W beton grey  
Alchemia CB1056 sedia | *chair*  
polipropilene P94 bianco ottico opaco  
polypropylene P94 matt optic white





# Athos

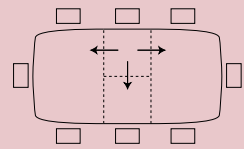
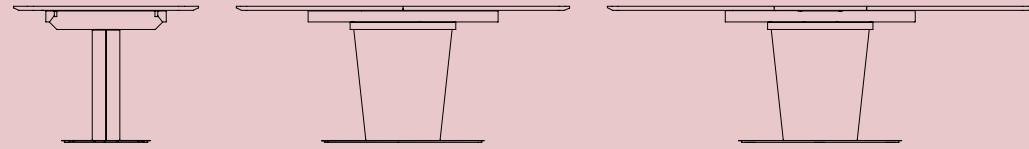

CB4783-R 150 | 150(200)x100 cm

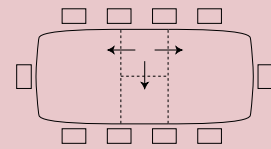

CB4783-R 180 | 180(230)x100 cm

tavoli fissi e allungabili | extending and non-extending tables



## colonna/piastra column/floor plate

metallo | metal

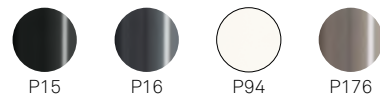

## piano top

ceramica | ceramic

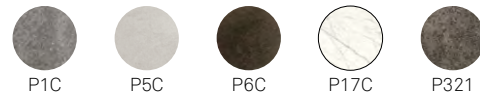

## FENIX<sup>NTM</sup>

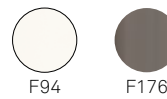

NOTA per le combinazioni disponibili consultare il listino prezzi. | NOTE please check all available combinations in the price list.

Athos CB4783-R tavolo allungabile | extending table  
metallo P94 bianco ottico opaco / ceramica P17C marmo bianco alpi  
metal P94 matt optic white / ceramic P17C white alpi marble

EASY  
 x-tension

ALLUNGA SEMI-AUTOMATICA tavolo allungabile con meccanismo semi automatico; le allunghe vengono posizionate agevolmente traslando su apposite guide.  
 SEMI-AUTOMATIC EXTENSION extendable table with semi-automatic mechanism; the extensions are easily aligned with the top by gliding on special runners.



**Athos CB4783-R** tavolo allungabile | *extending table*  
 metallo P94 bianco ottico opaco / ceramica P17C marmo bianco alpi  
 metal P94 matt optic white / ceramic P17C white alpi marble

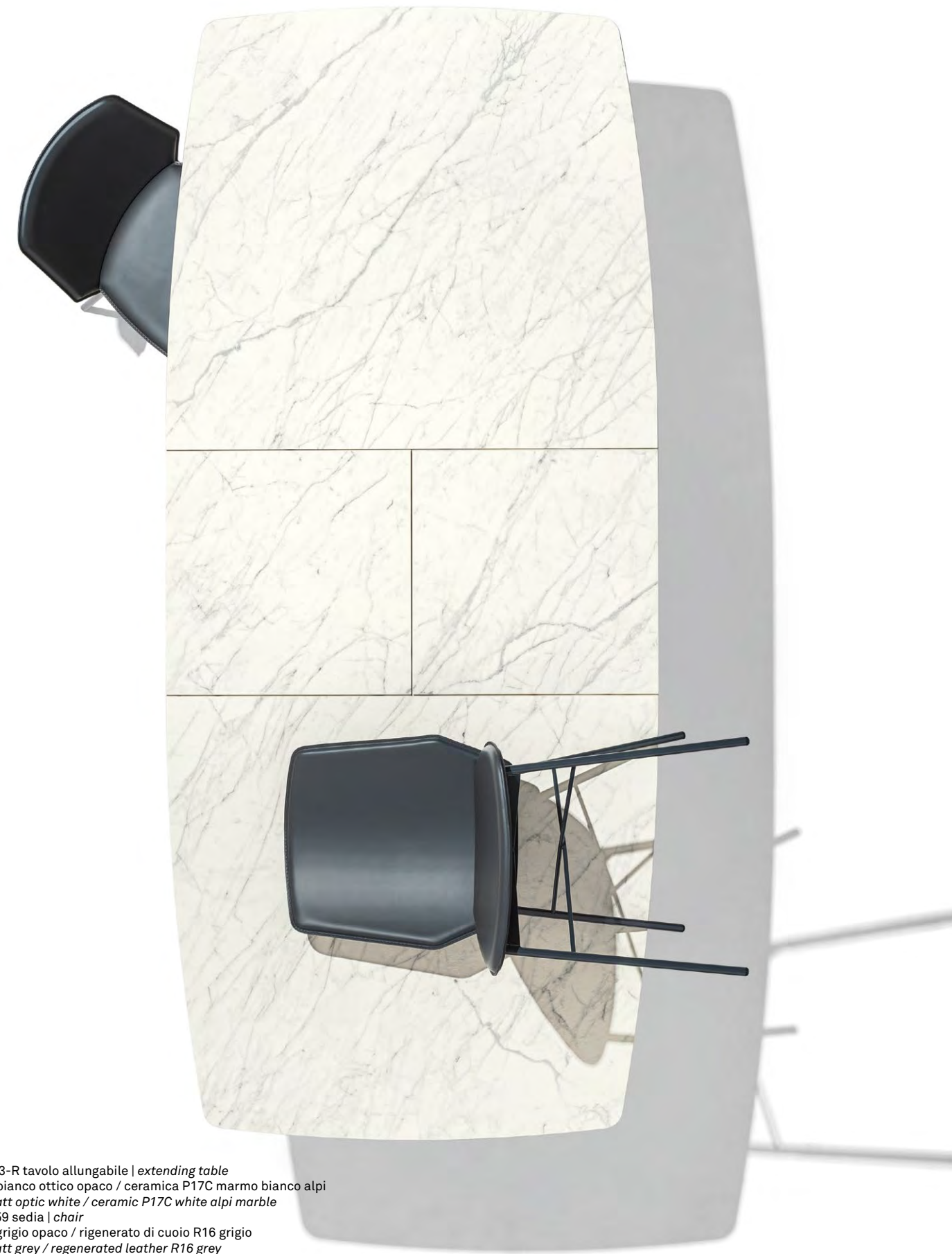

**Athos CB4783-R** tavolo allungabile | *extending table*  
 metallo P94 bianco ottico opaco / ceramica P17C marmo bianco alpi  
 metal P94 matt optic white / ceramic P17C white alpi marble  
**Sibilla CB1959** sedia | *chair*  
 metallo P16 grigio opaco / rigenerato di cuoio R16 grigio  
 metal P16 matt grey / regenerated leather R16 grey

Athos CB4783-R tavolo allungabile | *extending table*  
metallo P16 grigio opaco / ceramica P1C cemento  
*metal P16 matt grey / ceramic P1C cement*  
New York CB1022 sedia | *chair*  
metallo P16 grigio opaco / pelle L16 grigio  
*metal P16 matt grey / soft leather L16 grey*



# Baron

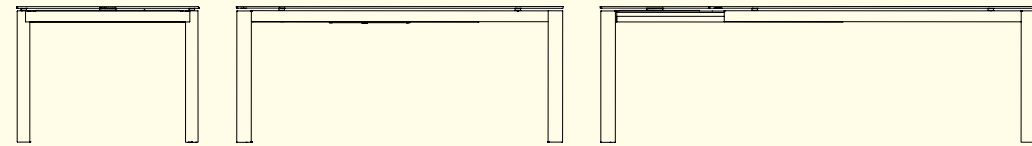

## TAVOLI FISSI/NON-EXTENDING TABLES

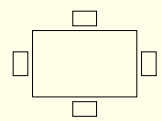

CB4010-FR 110 | 110x70 cm

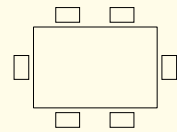

CB4010-FR 130 | 130x85 cm

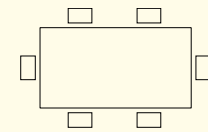

CB4010-FR 160 | 160x85 cm

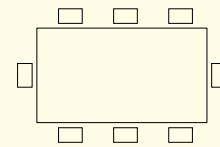

CB4010-FR 180 | 180x100 cm

## TAVOLI ALLUNGABILI/EXTENDING TABLES

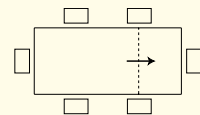

CB4010-R 110 | 110(155)x70 cm

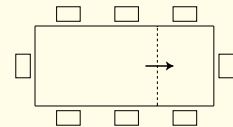

CB4010-R 130 | 130(190)x85 cm

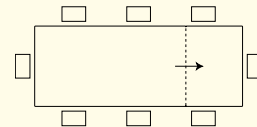

CB4010-R 160 | 160(220)x85 cm

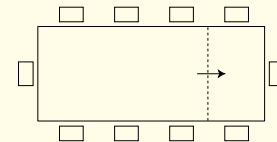

CB4010-R 180 | 180(240)x100 cm

### gambe legs

metallo | metal

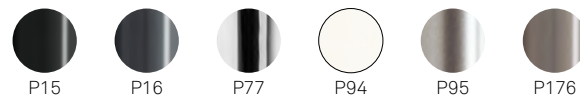

### piano top

ceramica | ceramic



vetro | glass



### FENIX NTM®

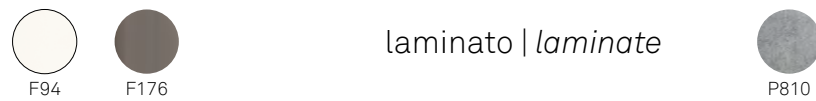

laminato | laminate

nobilitato | melamine



NOTA per le combinazioni disponibili consultare il listino prezzi. | NOTE please check all available combinations in the price list.

tavoli fissi e allungabili | extending and non-extending tables

Baron CB4010-R tavolo allungabile | extending table  
gambe 8A | 8A legs  
metallo P15 nero opaco / ceramica P321 piombo  
metal P15 matt black / ceramic P321 lead grey



Baron CB4010-R tavolo allungabile | *extending table*  
gambe 8A | *8A legs*  
metallo P94 bianco ottico opaco / vetro temprato GEW serigrafato extrachiaro  
*metal P94 matt optic white / tempered glass GEW frosted extraclear*  
metallo P95 acciaio satinato / ceramica P166 nocciola  
*metal P95 satin finished steel / ceramic P166 nougat*



SCELTA GAMBE | *LEG OPTIONS*

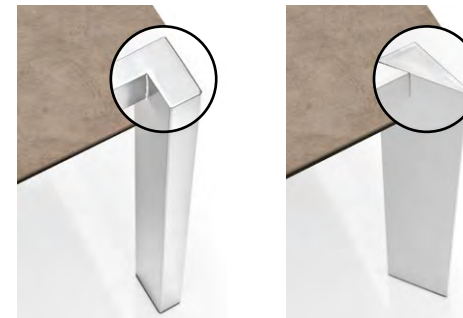

8A

8B

EASY  
x-tension

ALLUNGA SEMI-AUTOMATICA tavolo allungabile con meccanismo semi automatico; le allunghe vengono posizionate agevolmente traslando su apposite guide.  
*SEMI-AUTOMATIC EXTENSION extendable table with semi-automatic mechanism; the extensions are easily aligned with the top by gliding on special runners.*



1



2



3



4

**Baron** CB4010-R tavolo allungabile | *extending table*  
gambe 8B | *8B legs*  
metallo P16 grigio opaco / ceramica P1C cemento  
*metal P16 matt grey / ceramic P1C cement*  
**New York** CB1022 sedia | *chair*  
metallo P16 grigio opaco / pelle L16 grigio  
*metal P16 matt grey / soft leather L16 grey*





**Baron CB4010-FR tavolo fisso | non-extending table**  
 gambe 8B | 8B legs  
 metallo P15 nero opaco / nobilitato P50W bronzo ossido  
 metal P15 matt black / melamine P50W oxide bronze  
**Academy CB1663 sedia | chair**  
 metallo P15 nero opaco / rigenerato di cuoio R04 cognac  
 metal P15 matt black / regenerated leather R04 cognac



**Baron CB4010-FR tavolo fisso | non-extending table**  
 gambe 8B | 8B legs  
 metallo P15 nero opaco / nobilitato P50W bronzo ossido  
 metal P15 matt black / melamine P50W oxide bronze

Baron CB4010-R tavolo allungabile | *extending table*  
gambe 8A | *8A legs*  
metallo P94 bianco ottico opaco /  
vetro temprato GEW serigrafato extrachiaro  
*metal P94 matt optic white /*  
*tempered glass GEW frosted extraclear*  
Caffè CB1970 sedia | *chair*  
polipropilene P94 bianco ottico opaco  
*polypropylene P94 matt optic white*





# Baron Counter

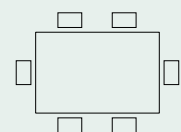
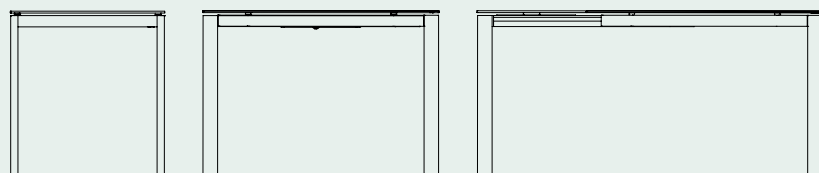

CB4010-FRH 130 | 130x85 H90 cm

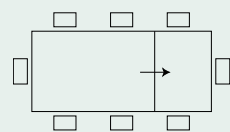

CB4010-RH 130 | 130(190)x85 H90 cm

## gambe legs

metallo | metal



## piano top

ceramica | ceramic



vetro | glass



**FENIX** NTM®

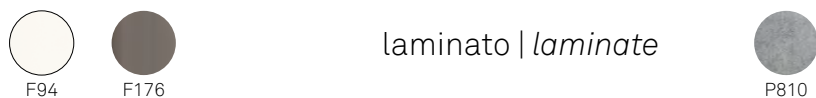

laminato | laminate

nobilitato | melamine



ALLUNGA SEMI-AUTOMATICA tavolo allungabile con meccanismo semi automatico; le allunghe vengono posizionate agevolmente traslando su apposite guide.  
SEMI-AUTOMATIC EXTENSION extendable table with semi-automatic mechanism; the extensions are easily aligned with the top by gliding on special runners.

NOTA per le combinazioni disponibili consultare il listino prezzi. | NOTE please check all available combinations in the price list.

**Baron Counter** CB4010-RH  
tavolo allungabile | *extending table*  
gambe 8A | 8A legs  
metallo P16 grigio opaco / ceramica P133 stone  
*metal P16 matt grey / ceramic P133 stone grey*  
**Bohème** CB1393 sgabello in metallo | *metal stool*  
P15 nero opaco / rigenerato di cuoio 315 nero  
*P15 matt black / regenerated leather 315 black*



# Bold

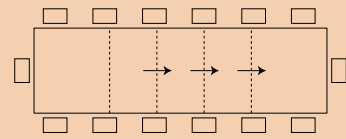
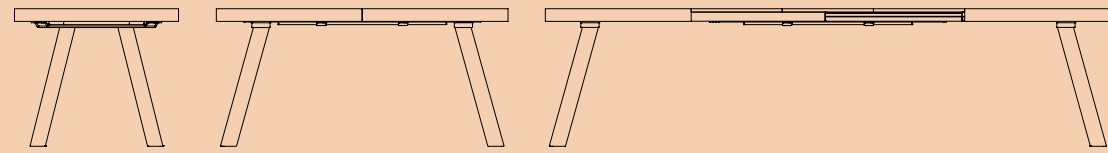

CB4795-R 160 | 160(210)(260)(310)x90 cm

## gambe legs

legno | wood



## piano top

nobilitato | melamine



MANUAL  
x-tension

NOTA per le combinazioni disponibili consultare il listino prezzi. | NOTE please check all available combinations in the price list.

tavoli fissi e allungabili | extending and non-extending tables



**Bold** CB4795-R 160 tavolo allungabile | *extending table*  
faggio P15 nero opaco / nobilitato P49W rovere naturale  
beech P15 matt black / melamine P49W natural oak

**Bold**

MANUAL  
x-tension

ALLUNGA MANUALE tavolo allungabile con meccanismo manuale; le allunghe vengono sollevate e posizionate all'altezza del piano principale.  
MANUAL EXTENSION extendable table with manual mechanism; the extensions are manually lifted and aligned with the top.



**Bold** CB4795-R 160 tavolo allungabile | *extending table*  
faggio P176 tortora opaco / nobilitato P60W termocotto  
beech P176 matt taupe / melamine P60W termocotto

tavoli fissi e allungabili | *extending and non-extending tables*



**Bold** CB4795-R 160 tavolo allungabile | *extending table*  
 faggio P176 tortora opaco / nobilitato P60W termocotto  
 beech P176 matt taupe / melamine P60W termocotto  
**Garda** CB1525 sedia | *chair*  
 metallo P176 tortora opaco / similpelle Ekos G8Q tortora  
 metal P176 matt taupe / Ekos faux leather G8Q taupe



## Cocktail / home selection

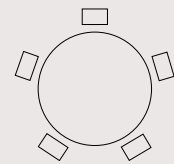
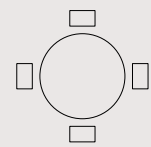
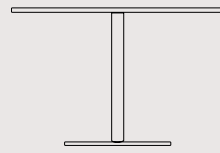
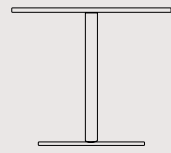

CB4759-FD 90 | Ø 90 cm

CB4759-FD 120 | Ø 120 cm

### colonna/piastra column/floor plate

metallo | metal

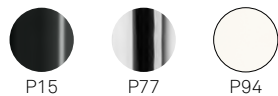

### piano top

laccato | lacquered



nobilitato | melamine

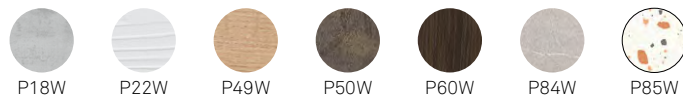

laminato | laminate

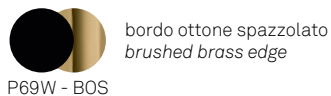

laminato stratificato |  
multilayer laminate



NOTA per le combinazioni disponibili consultare il listino prezzi. | NOTE please check all available combinations in the price list.

## tavoli fissi e allungabili | extending and non-extending tables

**Cocktail CB4759-FD 90**  
tavolo fisso | non-extending table  
metallo P15 nero opaco -  
P69W/BOS nero / ottone spazzolato  
metal P15 matt black -  
P69W/BOS black / brushed brass  
**Academy CB1663 sedia** | chair  
metallo P33L ottone verniciato /  
tessuto Mat SLL limone  
metal P33L Painted Brass /  
Mat fabric SLL lemon yellow



# Dine

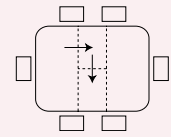
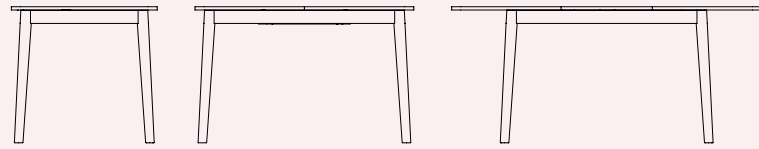

CB4094-Q 90 | 90(130)x90 cm

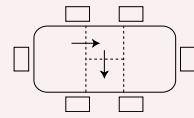

CB4094-R 110 | 110(150)x70 cm

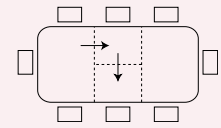

CB4094-R 120 | 120(170)x80 cm

## gambe legs

legno | wood

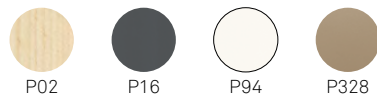

## piano top

nobilitato | melamine

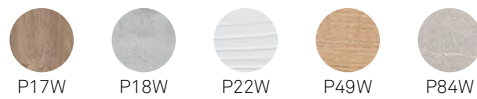

ALLUNGHE LACCATE | LACQUERED EXTENSION

MANUAL  
x-tension

NOTA per le combinazioni disponibili consultare il listino prezzi. | NOTE please check all available combinations in the price list.

## tavoli fissi e allungabili | extending and non-extending tables

Dine CB4094-R tavolo allungabile | extending table  
faggio P16 grigio opaco / nobilitato P18W beton grigio  
beech P16 matt grey / melamine P18W beton grey



MANUAL  
x-tension

ALLUNGA MANUALE tavolo allungabile con meccanismo manuale; le allunghe vengono sollevate e posizionate all'altezza del piano principale.  
 MANUAL EXTENSION extendable table with manual mechanism; the extensions are manually lifted and aligned with the top.



Dine CB4094-R tavolo allungabile | *extending table*  
 faggio P16 grigio opaco / nobilitato P18W beton grigio  
 beech P16 matt grey / melamine P18W beton grey



Dine CB4094-R  
 tavolo allungabile | *extending table*  
 faggio P02 faggio sbiancato /  
 nobilitato P84W pietra piacentina  
 beech P02 bleached beechwood /  
 melamine P84W piacentina stone

Dine CB4094-R tavolo allungabile | *extending table*  
faggio P94 bianco ottico opaco / nobilitato P49W rovere naturale  
*beech P94 matt optic white / melamine P49W natural oak*  
Robinson Soft CB1436-S sedia | *chair*  
faggio P94 bianco ottico opaco / tessuto Berna 1SA6 tortora  
*beech P94 matt optic white / Berna fabric 1SA6 taupe*





# Eminence Metal

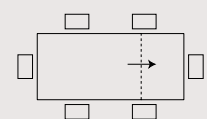
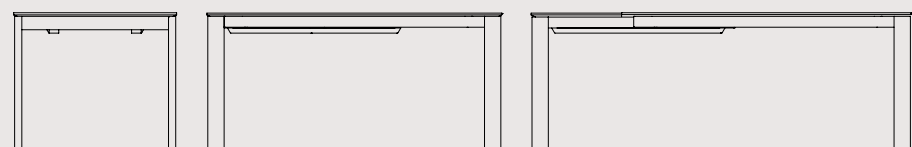

CB4724-R 110 A | 110(155)x70 cm

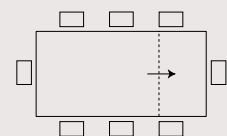

CB4724-R 130 A | 130(180)x90 cm

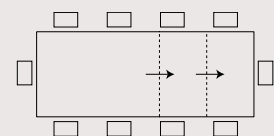

CB4724-R 130 B | 130(180)(230)x90 cm

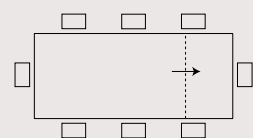

CB4724-R 160 A | 160(210)x90 cm

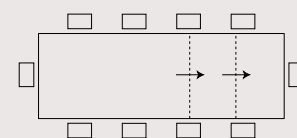

CB4724-R 160 B | 160(210)(260)x90 cm

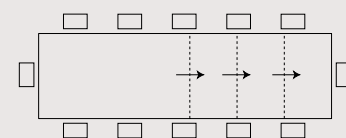

CB4724-R 160 C | 160(210)(260)(310)x90 cm

## gambe/cassonetto legs/frame

metallo | metal



## piano top

ceramica | ceramic



vetro | glass



laminato | laminate



nobilitato | melamine



PIANI IN CERAMICA E IN VETRO CON ALLUNGHE IN LAMINATO - PIANI IN NOBILITATO CON ALLUNGHE NELLA STESSA FINITURA | CERAMIC OR GLASS TOPS AND LAMINATE EXTENTIONS - MELAMINE TOPS AND EXTENSIONS IN THE SAME FINISH



NOTA per le combinazioni disponibili consultare il listino prezzi. | NOTE please check all available combinations in the price list.

tavoli fissi e allungabili | extending and non-extending tables

Eminence CB4724-R tavolo allungabile | extending table  
metallo P15 nero opaco / nobilitato P50W bronzo ossido  
metal P15 matt black / melamine P50W oxide bronze



## Eminence Metal

MANUAL  
x-tension

ALLUNGA MANUALE tavolo allungabile con meccanismo manuale; le allunghe vengono sollevate e posizionate all'altezza del piano principale.  
MANUAL EXTENSION extendable table with manual mechanism; the extensions are manually lifted and aligned with the top.



**Eminence CB4724-R** tavolo allungabile | *extending table*  
metallo P94 bianco ottico opaco / nobilitato P17W deco nocciola  
metal P94 matt optic white / melamine P17W deco nougat

## tavoli fissi e allungabili | extending and non-extending tables

GAMBA METALLO  
METAL LEG



**Eminence CB4724-R** tavolo allungabile | *extending table*  
metallo P16 grigio opaco / ceramica P133 stone | metal P16 matt grey / ceramic P133 stone grey  
**Emma CB1662** sedia | *chair*  
metallo P16 grigio opaco / similpelle Ekos G8R grigio | metal P16 matt grey / Ekos faux leather G8R grey

**Eminence** CB4724-R tavolo allungabile | *extending table*  
metallo P15 nero opaco / ceramica P321 piombo  
*metal P15 matt black / ceramic P321 lead grey*  
Up! CB1955 sedia | *chair*  
metallo P15 nero opaco / similpelle Ekos G8N nero  
*metal P15 matt black / Ekos faux leather G8N black*



**Eminence CB4724-R**  
tavolo allungabile | *extending table*  
metallo P94 bianco ottico opaco /  
vetro temprato GEW serigrafato extrachiaro  
*metal P94 matt optic white /*  
*tempered glass GEW frosted extraclear*  
**Gamera CB1459** sedia | *chair*  
nylon P973 senape opaco  
*nylon P973 matt mustard yellow*



# Eminence Wood

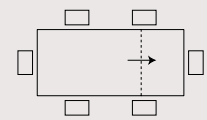
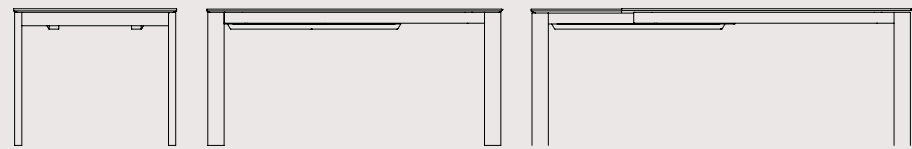

CB4724-R 110 A | 110(155)x70 cm

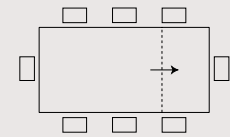

CB4724-R 130 A | 130(180)x90 cm

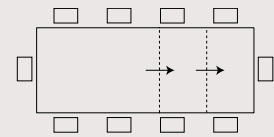

CB4724-R 130 B | 130(180)(230)x90 cm

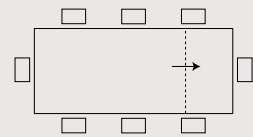

CB4724-R 160 A | 160(210)x90 cm

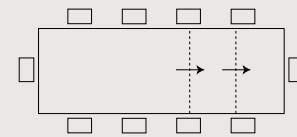

CB4724-R 160 B | 160(210)(260)x90 cm

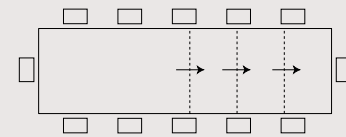

CB4724-R 160 C | 160(210)(260)(310)x90 cm

## gambe legs

legno | wood



## cassonetto frame

metallo | metal



## piano top

ceramica | ceramic

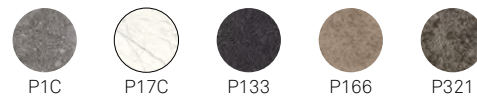

vetro | glass

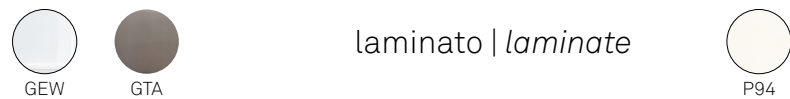

nobilitato | melamine



PIANI IN CERAMICA E IN VETRO CON ALLUNGHE IN LAMINATO - PIANI IN NOBILITATO CON ALLUNGHE NELLA STESSA FINITURA | CERAMIC OR GLASS TOPS AND LAMINATE EXTENSIONS - MELAMINE TOPS AND EXTENSIONS IN THE SAME FINISH



NOTA per le combinazioni disponibili consultare il listino prezzi. | NOTE please check all available combinations in the price list.

**Eminence CB4724-R**  
tavolo allungabile | *extending table*  
frassino P19W rovere naturale / metallo P94 bianco  
ottico opaco / laminato P94 bianco ottico opaco  
*ashwood P19W natural oak / metal P94 matt  
optic white / laminate P94 matt optic white*  
**Academy CB1665 sedia** | *chair*  
frassino P19W rovere naturale /  
polipropilene P94 bianco ottico opaco  
*ashwood P19W natural oak /  
polypropylene P94 matt optic white*



## Eminence Wood

MANUAL  
x-tension

ALLUNGA MANUALE tavolo allungabile con meccanismo manuale; le allunghe vengono sollevate e posizionate all'altezza del piano principale.  
MANUAL EXTENSION extendable table with manual mechanism; the extensions are manually lifted and aligned with the top.



**Eminence CB4724-R** tavolo allungabile | *extending table*  
faggio P94 bianco ottico opaco / metallo P94 bianco ottico opaco / nobilitato P17W deco nocciola  
beech P94 matt optic white / metal P94 matt optic white / melamine P17W deco nougat

## tavoli fissi e allungabili | extending and non-extending tables

GAMBA LEGNO  
WOODEN LEG

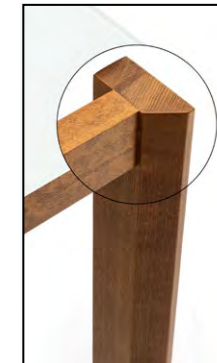

**Eminence CB4724-R** tavolo allungabile | *extending table*  
faggio P201 noce / metallo P176 tortora opaco / ceramica P321 piombo  
beech P201 walnut / metal P176 matt taupe / ceramic P321 lead grey  
**Sibilla CB1959** sedia | *chair*  
metallo P15 nero opaco / rigenerato di cuoio 315 nero  
metal P15 matt black / regenerated leather 315 black

**Eminence CB4724-R**  
tavolo allungabile | *extending table*  
faggio P132 grafite / metallo P15 nero opaco /  
nobilitato P47W rovere tabacco  
beech P132 graphite / metal P15 matt black /  
melamine P47W tobacco oak



# Eminence Fast

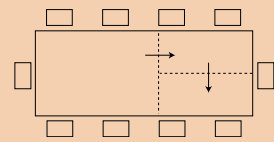
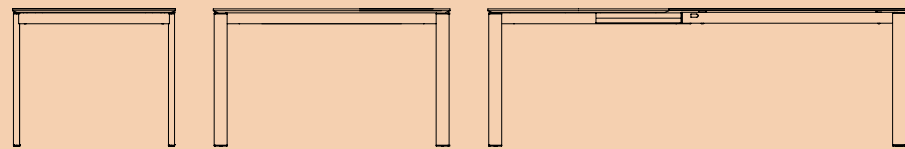

CB4788-R 130 | 130(230)x90 cm

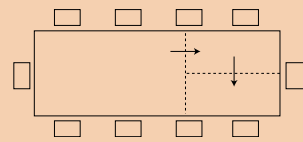

CB4788-R 160 | 160(260)x90 cm

## gambe legs

metallo | metal

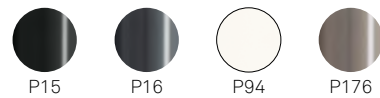

legno | wood



## cassonetto frame

metallo | metal

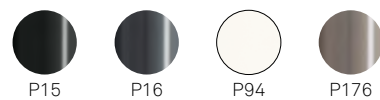

## piano top

ceramica | ceramic



NOTA per le combinazioni disponibili consultare il listino prezzi. | NOTE please check all available combinations in the price list.

tavoli fissi e allungabili | extending and non-extending tables

**Eminence Fast CB4788-R**  
tavolo allungabile | *extending table*  
faggio P201 noce /  
ceramica P1C cemento  
beech P201 walnut /  
ceramic P1C cement





**Eminence Fast CB4788-R**  
tavolo allungabile | *extending table*  
frassino P19W rovere naturale /  
metallo P15 nero opaco / ceramica P5C sale  
*ashwood P19W natural oak /*  
*metal P15 matt black / ceramic P5C salt white*  
**Academy CB1665 sedia** | *chair*  
frassino P19W rovere naturale /  
rigenerato di cuoio 474 bianco ottico  
*ashwood P19W natural oak /*  
*regenerated leather 474 optic white*



## Eminence Fast

EASY  
x-tension

ALLUNGA SEMI-AUTOMATICA tavolo allungabile con meccanismo semi automatico; le allunghe vengono posizionate agevolmente traslando su apposite guide.  
SEMI-AUTOMATIC EXTENSION extendable table with semi-automatic mechanism; the extensions are easily aligned with the top by gliding on special runners.



**Eminence Fast CB4788-R** tavolo allungabile | *extending table*  
metallo P15 nero opaco / metallo P15 nero opaco / ceramica P321 piombo  
*metal P15 matt black / metal P15 matt black / ceramic P321 lead grey*

## tavoli fissi e allungabili | extending and non-extending tables



**Eminence Fast CB4788-R**  
tavolo allungabile | *extending table*  
faggio P132 grafite / metallo P15 nero opaco /  
ceramica P6C ossido nero  
*beech P132 graphite / metal P15 matt black /  
ceramic P6C black oxide*

# Excellence

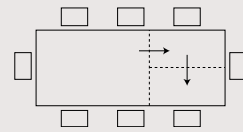
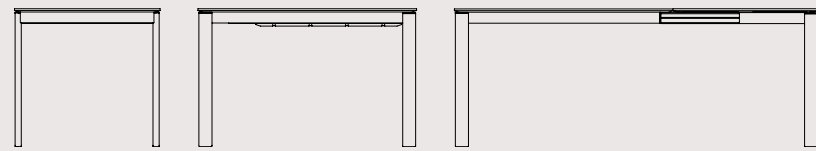

CB4784-R 120 | 120(200)x80 cm

## gambe legs

metallo | *metal*

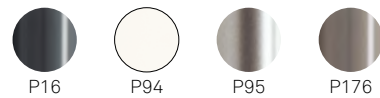

## piano top

nobilitato | *melamine*

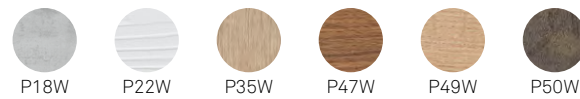

EASY  
x-tension

tavoli fissi e allungabili | *extending and non-extending tables*

**Excellence CB4784-R 120**  
 tavolo allungabile | *extending table*  
 metallo P176 tortora opaco /  
 nobilitato P50W bronzo ossido  
*metal P176 matt taupe /*  
*melamine P50W oxide bronze*  
**Jelly Metal CB1954** sedia | *chair*  
 metallo P176 tortora opaco /  
 polipropilene P900 tortora opaco  
*metal P176 matt optic white /*  
*polypropylene P900 matt taupe*



NOTA per le combinazioni disponibili consultare il listino prezzi. | *NOTE please check all available combinations in the price list.*

EASY  
x-tension

ALLUNGA SEMI-AUTOMATICA tavolo allungabile con meccanismo semi automatico; le allunghe vengono posizionate agevolmente traslando su apposite guide.

SEMI-AUTOMATIC EXTENSION extendable table with semi-automatic mechanism; the extensions are easily aligned with the top by gliding on special runners.



Excellence CB4784-R 120 tavolo allungabile | *extending table*  
metallo P95 acciaio satinato / nobilitato P35W vintage  
*metal P95 satin finished steel / melamine P35W vintage*

Excellence CB4784-R 120  
tavolo allungabile | *extending table*  
metallo P94 bianco ottico opaco /  
nobilitato P35W vintage  
*metal P94 matt optic white /*  
*melamine P35W vintage*

Academy CB1663 sedia | *chair*  
metallo P94 bianco ottico opaco /  
polipropilene P94 bianco ottico opaco  
*metal P94 matt optic white /*  
*polypropylene P94 matt optic white*



# Gate

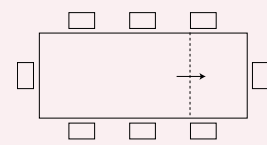
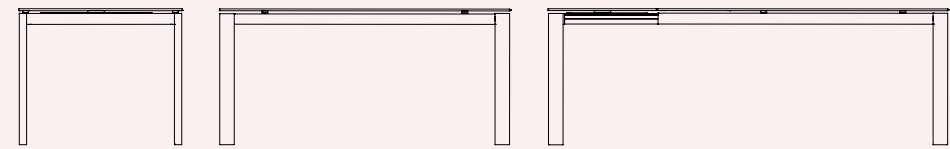

CB4088-R 160 | 160(220)x90 cm

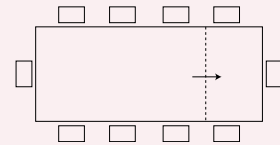

CB4088-R 180 | 180(240)x100 cm

## gambe/cassonetto legs/frame

metallo | metal

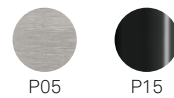

## piano top

ceramica | ceramic



vetro | glass



NOTA per le combinazioni disponibili consultare il listino prezzi. | NOTE please check all available combinations in the price list.

## tavoli fissi e allungabili | extending and non-extending tables

Gate CB4088-R tavolo allungabile | extending table  
metallo P15 nero opaco / ceramica P5C sale  
metal P15 matt black / ceramic P5C salt white



EASY  
x-tension

ALLUNGA SEMI-AUTOMATICA tavolo allungabile con meccanismo semi automatico; le allunghe vengono posizionate agevolmente traslando su apposite guide.  
SEMI-AUTOMATIC EXTENSION extendable table with semi-automatic mechanism; the extensions are easily aligned with the top by gliding on special runners.



Gate CB4088-R tavolo allungabile | *extending table*  
metallo P15 nero opaco / ceramica P133 stone  
metal P15 matt black / ceramic P133 stone grey

Gate CB4088-R tavolo allungabile | *extending table*  
metallo P15 nero opaco / ceramica P133 stone  
metal P15 matt black / ceramic P133 stone grey



Gate CB4088-R tavolo allungabile | *extending table*  
metallo P15 nero opaco / ceramica P5C sale  
*metal P15 matt black / ceramic P5C salt white*  
New York CB1022 sedia | *chair*  
metallo P15 nero opaco / similpelle Vintage S0A deserto  
*metal P15 matt black / Vintage faux leather S0A desert*



# Giove

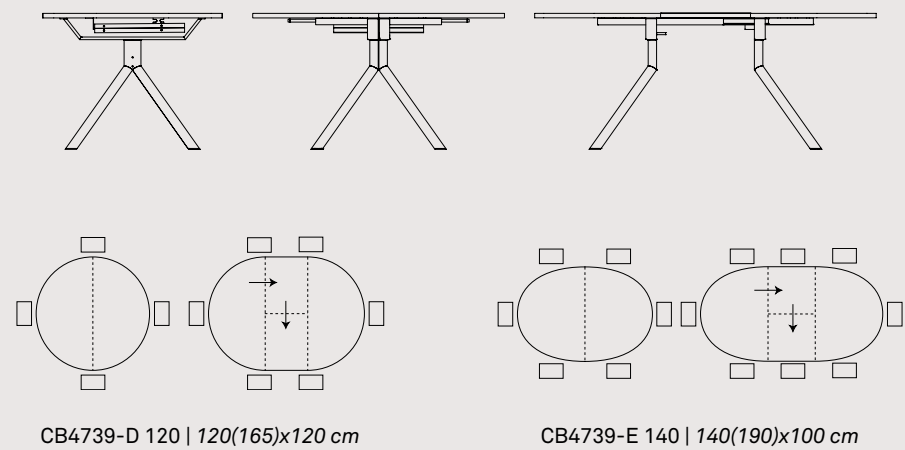

CB4739-D 120 | 120(165)x120 cm

CB4739-E 140 | 140(190)x100 cm

## basamento base

metallo | *metal*



## piano top

ceramica | *ceramic*



vetro | *glass*



nobilitato | *melamine*

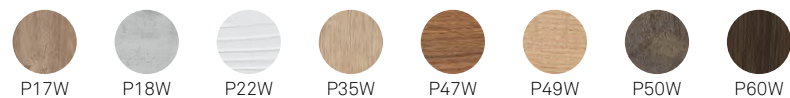

PIANI IN CERAMICA E IN VETRO CON ALLUNGHE IN LAMINATO - PIANI IN NOBILITATO CON ALLUNGHE NELLA STESSA FINITURA |  
CERAMIC OR GLASS TOPS AND LAMINATE EXTENTIONS - MELAMINE TOPS AND EXTENSIONS IN THE SAME FINISH



NOTA per le combinazioni disponibili consultare il listino prezzi. | NOTE please check all available combinations in the price list.

## tavoli fissi e allungabili | extending and non-extending tables

Giove CB4739-D 120 tavolo allungabile | *extending table*  
metallo P16 grigio opaco / nobilitato P18W beton grigio  
*metal P16 matt grey / melamine P18W beton grey*  
Sibilla CB1959 sedia | *chair*  
metallo P16 grigio opaco / rigenerato di cuoio R16 grigio  
*metal P16 matt grey / regenerated leather R16 grey*





EASY  
x-tension

ALLUNGA SEMI-AUTOMATICA tavolo allungabile con meccanismo semi automatico; le allunghe vengono posizionate agevolmente traslando su apposite guide.

SEMI-AUTOMATIC EXTENSION extendable table with semi-automatic mechanism; the extensions are easily aligned with the top by gliding on special runners.



Giove CB4739-D 120 tavolo allungabile | *extending table*  
metallo P15 nero opaco / nobilitato P60W termocotto  
metal P15 matt black / melamine P60W termocotto



Giove CB4739-D 120 tavolo allungabile | *extending table*  
metallo P15 nero opaco / ceramica P133 stone  
metal P15 matt black / ceramic P133 stone grey

EASY  
x-tension

ALLUNGA SEMI-AUTOMATICA tavolo allungabile con meccanismo semi automatico; le allunghe vengono posizionate agevolmente traslando su apposite guide.

SEMI-AUTOMATIC EXTENSION extendable table with semi-automatic mechanism; the extensions are easily aligned with the top by gliding on special runners.



Giove CB4739-E 140 tavolo allungabile | *extending table*  
metallo P176 tortora opaco / ceramica P321 piombo  
metal P176 matt taupe / ceramic P321 lead grey

Giove CB4739-E 140  
tavolo allungabile | *extending table*  
metallo P176 tortora opaco /  
ceramica P321 piombo  
metal P176 matt taupe /  
ceramic P321 lead grey  
Academy CB1663 sedia | *chair*  
metallo P176 tortora opaco /  
polipropilene P900 tortora opaco  
metal P176 matt taupe /  
polypropylene P900 matt taupe

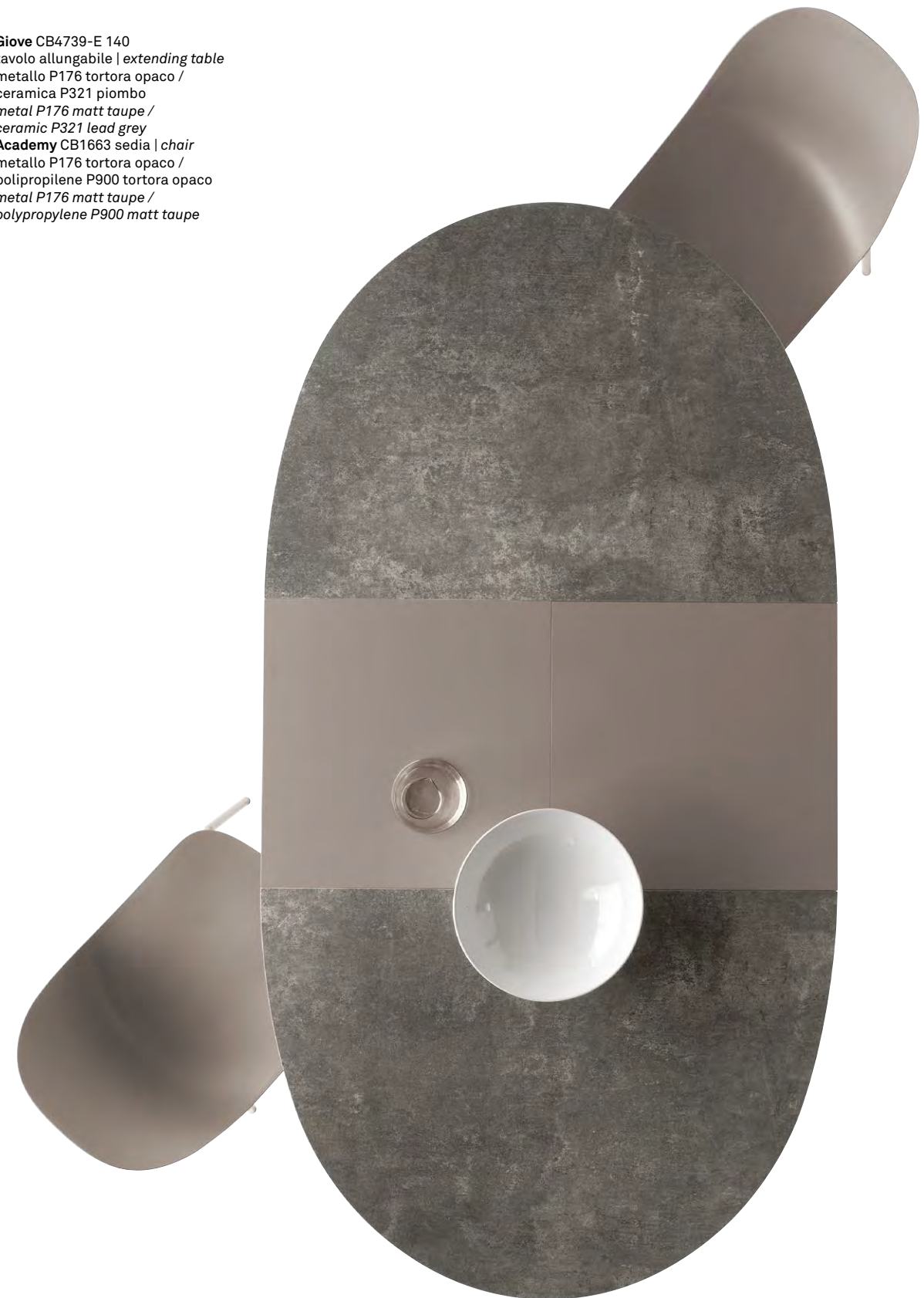

**Giove** CB4739-E 140  
tavolo allungabile | *extending table*  
metallo P94 bianco ottico opaco /  
vetro temprato GEW serigrafato extrachiaro  
*metal P94 matt optic white /*  
*tempered glass GEW frosted extraclear*  
**Gamera** CB1459 sedia | *chair*  
nylon P94 bianco ottico opaco  
*nylon P94 matt optic white*



# Mikado Fix

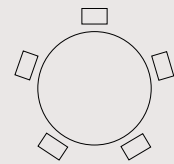
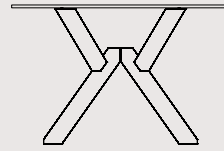

CB4728-FD 120 | Ø 120 cm

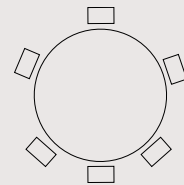

CB4728-FD 140 | Ø 140 cm

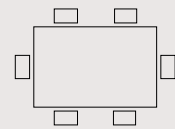

CB4728-FR 130 | 130x85 cm



CB4728-FR 160 | 160x90 cm



CB4728-FR 180 | 180x90 cm

## basamento base

legno | wood

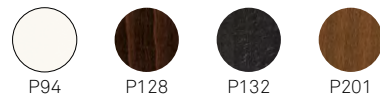

P94

P128

P132

P201

## piano top

vetro | glass



GTR

tavoli fissi e allungabili | extending and non-extending tables

**Mikado CB4728-FD**  
tavolo fisso | *non-extending table*  
faggio P132 grafite /  
vetro temprato GTR trasparente  
beech P132 graphite /  
tempered glass GTR transparent



NOTA per le combinazioni disponibili consultare il listino prezzi. | NOTE please check all available combinations in the price list.



**Mikado CB4728-FD** tavolo fisso | *non-extending table*  
faggio P132 grafite / vetro temprato GTR trasparente  
beech P132 graphite / tempered glass GTR transparent



**Mikado CB4728-FR**  
tavolo fisso | *non-extending table*  
faggio P201 noce /  
vetro temprato GTR trasparente  
beech P201 walnut /  
tempered glass GTR transparent  
**Sibilla CB1959** sedia | *chair*  
metallo P15 nero opaco /  
rigenerato di cuoio 315 nero  
metal P15 matt black /  
regenerated leather 315 black

# Mikado

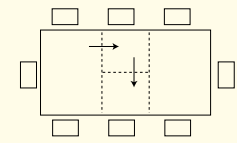
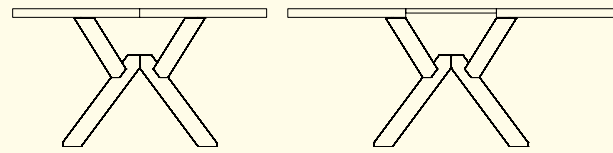

CB4789-R 130 | 130(180)x90 cm

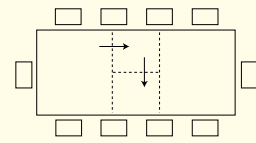

CB4789-R 160 | 160(210)x90 cm

## basamento base

legno | wood



## piano top

nobilitato | melamine

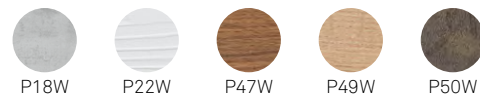

MANUAL  
x-tension

NOTA per le combinazioni disponibili consultare il listino prezzi. | NOTE please check all available combinations in the price list.

tavoli fissi e allungabili | extending and non-extending tables

**Mikado** CB4789-R  
tavolo allungabile | *extending table*  
faggio P176 tortora opaco /  
nobilitato P50W bronzo ossido  
beech P176 matt taupe /  
melamine P50W oxide bronze



## Mikado

MANUAL  
x-tension

ALLUNGA MANUALE tavolo allungabile con meccanismo manuale; le allunghe vengono sollevate e posizionate all'altezza del piano principale.  
MANUAL EXTENSION extendable table with manual mechanism; the extensions are manually lifted and aligned with the top.



Mikado CB4789-R tavolo allungabile | *extending table*  
faggio P16 grigio opaco / nobilitato P47W rovere tabacco  
beech P16 matt grey / melamine P47W tobacco oak

## tavoli fissi e allungabili | *extending and non-extending tables*

Mikado CB4789-R  
tavolo allungabile | *extending table*  
faggio P176 tortora opaco /  
nobilitato P50W bronzo ossido  
beech P176 matt taupe /  
melamine P50W oxide bronze  
Up! CB1955 sedia | *chair*  
metallo P176 tortora opaco /  
similpelle Ekos G8Q tortora  
metal P176 matt taupe /  
Ekos faux leather G8Q taupe



# Pegaso

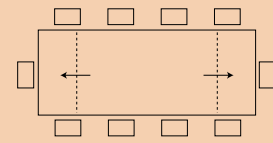
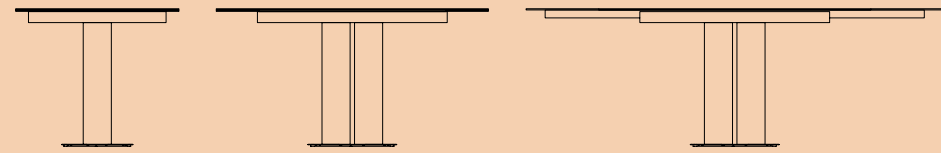

CB4799-R 150 | 150(190)(230)x90 cm

## colonna/piastra column/floor plate

metallo | metal



## piano top

ceramica | ceramic



EASY  
x-tension

NOTA per le combinazioni disponibili consultare il listino prezzi. | NOTE please check all available combinations in the price list.

tavoli fissi e allungabili | extending and non-extending tables

**Pegaso** CB4799-R 150 tavolo allungabile | *extending table*  
metallo P15 nero opaco / ceramica P5C sale  
*metal P15 matt black / ceramic P5C salt white*





Pegaso

EASY  
x-tension

ALLUNGA SEMI-AUTOMATICA tavolo allungabile con meccanismo semi automatico; le allunghe vengono posizionate agevolmente traslando su apposite guide.

SEMI-AUTOMATIC EXTENSION extendable table with semi-automatic mechanism; the extensions are easily aligned with the top by gliding on special runners.



Pegaso CB4799-R 150 tavolo allungabile | *extending table*  
metallo P94 bianco ottico opaco / ceramica P17C marmo bianco alpi  
*metal P94 matt optic white / ceramic P17C white alpi marble*

tavoli fissi e allungabili | *extending and non-extending tables*

Pegaso CB4799-R 150  
tavolo allungabile | *extending table*  
metallo P94 bianco ottico opaco /  
ceramica P17C marmo bianco alpi  
*metal P94 matt optic white /  
ceramic P17C white alpi marble*



**Pegaso** CB4799-R 150 tavolo allungabile | *extending table*  
metallo P15 nero opaco / ceramica P321 piombo  
*metal P15 matt black / ceramic P321 lead grey*  
**New York** CB1022 sedia | *chair*  
metallo P15 nero opaco / pelle 683 nero  
*metal P15 matt black / soft leather 683 black*



# Pentagon

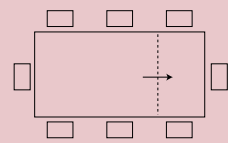
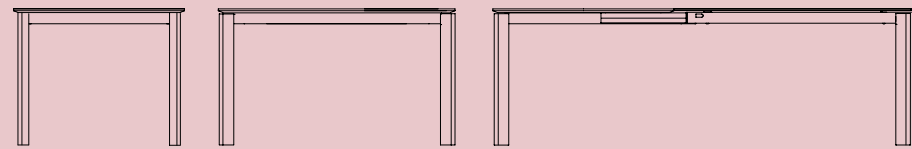

CB4797-R 130 A | 130(180)x90 cm

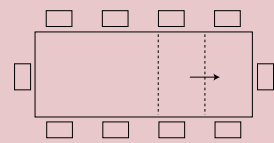

CB4797-R 130 B | 130(180)(230)x90 cm

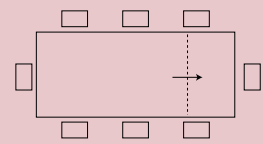

CB4797-R 160 A | 160(210)x90 cm

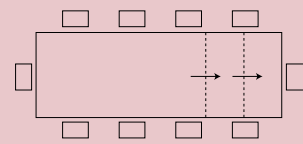

CB4797-R 160 B | 160(210)(260)x90 cm

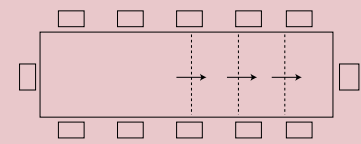

CB4797-R 160 C | 160(210)(260)(310)x90 cm

## gambe legs

metallo | *metal*



## piano top

ceramica | *ceramic*



vetro | *glass*

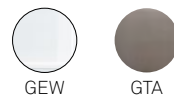

laminato | *lamine*



nobilitato | *melamine*



PIANI IN CERAMICA E IN VETRO CON ALLUNGHE IN LAMINATO - PIANI IN NOBILITATO CON ALLUNGHE NELLA STESSA FINITURA |  
CERAMIC OR GLASS TOPS AND LAMINATE EXTENTIONS - MELAMINE TOPS AND EXTENSIONS IN THE SAME FINISH



NOTA per le combinazioni disponibili consultare il listino prezzi. | NOTE please check all available combinations in the price list.

tavoli fissi e allungabili | extending and non-extending tables

**Pentagon CB4797-R**  
tavolo allungabile | *extending table*  
metallo P94 bianco ottico opaco /  
nobilitato P84W pietra piasentina  
metal P94 matt optic white /  
melamine P84W piasentina stone



## Pentagon

MANUAL  
x-tension

ALLUNGA MANUALE tavolo allungabile con meccanismo manuale; le allunghe vengono sollevate e posizionate all'altezza del piano principale.  
MANUAL EXTENSION extendable table with manual mechanism; the extensions are manually lifted and aligned with the top.



**Pentagon CB4797-R** tavolo allungabile | *extending table*  
metallo P94 bianco ottico opaco / vetro temprato GEW serigrafato extrachiaro  
metal P94 matt optic white / tempered glass GEW frosted extraclear

## tavoli fissi e allungabili | extending and non-extending tables



**Pentagon CB4797-R** tavolo allungabile | *extending table*  
metallo P94 bianco ottico opaco / vetro temprato GEW serigrafato extrachiaro  
metal P94 matt optic white / tempered glass GEW frosted extraclear  
**Academy CB1664** sedia | *chair*  
metallo P3L rosso ossido opaco / polipropilene P3L rosso ossido opaco  
metal P3L matt oxide red / polypropylene P3L matt oxide red

Pentagon

Pentagon CB4797-R tavolo allungabile | *extending table*  
metallo P16 grigio opaco / ceramica P1C cemento  
*metal P16 matt grey / ceramic P1C cement*  
Garda CB1525 sedia | *chair*  
metallo P16 grigio opaco / similpelle Ekos G8R grigio  
*metal P16 matt grey / Ekos faux leather G8R grey*



tavoli fissi e allungabili | *extending and non-extending tables*



Pentagon CB4797-R tavolo allungabile | *extending table*  
 metallo P15 nero opaco / nobilitato P47W rovere tabacco  
*metal P15 matt black / melamine P47W tobacco oak*  
 Sibilla CB1959 sedia | *chair*  
 metallo P15 nero opaco / rigenerato di cuoio R04 cognac  
*metal P15 matt black / regenerated leather R04 cognac*



# Pentagon Fast

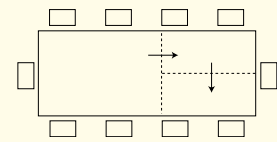
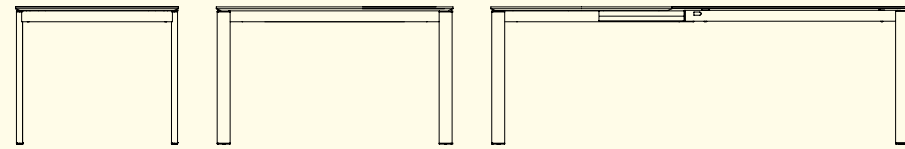

CB4800-R 130 | 130(230)x90 cm

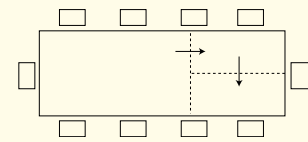

CB4800-R 160 | 160(260)x90 cm

## gambe legs

metallo | *metal*

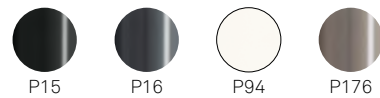

## piano top

ceramica | *ceramic*

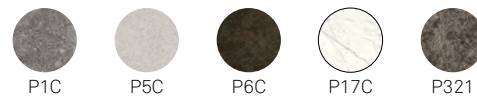

NOTA per le combinazioni disponibili consultare il listino prezzi. | NOTE please check all available combinations in the price list.

tavoli fissi e allungabili | extending and non-extending tables

**Pentagon Fast CB4800-R**  
tavolo allungabile | *extending table*  
metallo P94 bianco ottico opaco /  
ceramica P17C marmo bianco alpi  
*metal P94 matt optic white /*  
*ceramic P17C white alpi marble*



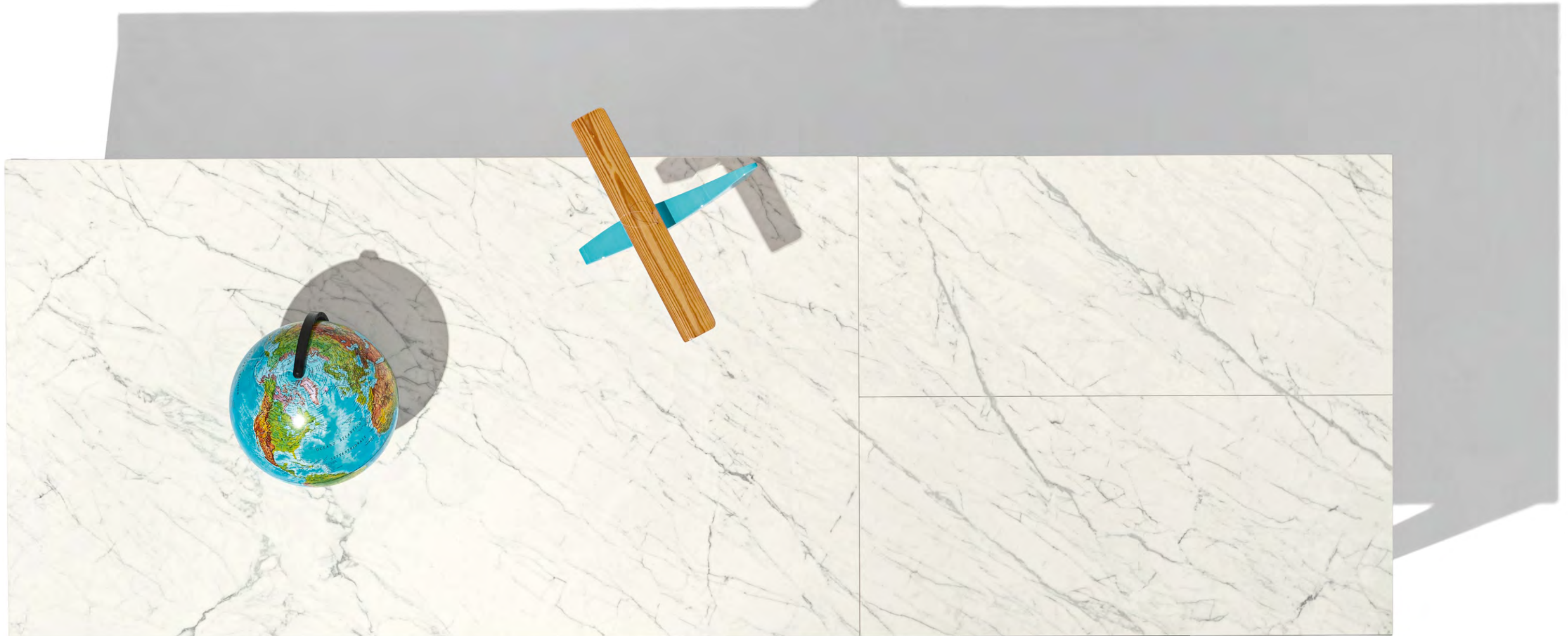

**Pentagon Fast** CB4800-R tavolo allungabile | *extending table*  
metallo P94 bianco ottico opaco / ceramica P17C marmo bianco alpi  
*metal P94 matt optic white / ceramic P17C white alpi marble*  
**Academy** CB1665 sedia | *chair*  
faggio P02 faggio sbiancato / tessuto Mat SLQ grigio  
*beech P02 bleached beechwood / Mat fabric SLQ grey*



Pentagon Fast

EASY  
x-tension

ALLUNGA SEMI-AUTOMATICA tavolo allungabile con meccanismo semi automatico; le allunghe vengono posizionate agevolmente traslando su apposite guide.

SEMI-AUTOMATIC EXTENSION extendable table with semi-automatic mechanism; the extensions are easily aligned with the top by gliding on special runners.



Pentagon Fast CB4800-R tavolo allungabile | extending table  
metallo P15 nero opaco / ceramica P6C ossido nero  
metal P15 matt black / ceramic P6C black oxide

tavoli fissi e allungabili | extending and non-extending tables

Pentagon Fast CB4800-R  
tavolo allungabile | extending table  
metallo P15 nero opaco /  
ceramica P6C ossido nero  
metal P15 matt black /  
ceramic P6C black oxide



**Pentagon Fast CB4800-R**  
tavolo allungabile | *extending table*  
metallo P15 nero opaco /  
ceramica P6C ossido nero  
*metal P15 matt black /*  
*ceramic P6C black oxide*  
**Caffè CB1970 sedia** | *chair*  
polipropilene P973 senape opaco  
*polypropylene P973 matt mustard yellow*



# Planet

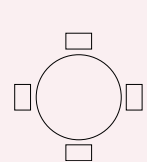
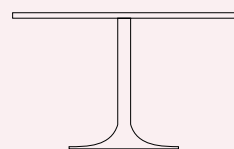

CB4005-FD 90 | Ø 90 cm

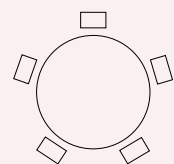

CB4005-FD 120 | Ø 120 cm

## colonna/piastra column/floor plate

metallo | metal

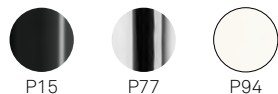

## piano top

vetro | glass



laccato | lacquered



nobilitato | melamine

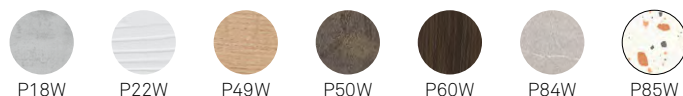

laminato | laminate



laminato stratificato |  
multilayer laminate



NOTA per le combinazioni disponibili consultare il listino prezzi. | NOTE please check all available combinations in the price list.

## tavoli fissi e allungabili | extending and non-extending tables

**Planet CB4005-FD**  
tavolo fisso | non-extending table  
metallo P94 bianco ottico opaco /  
nobilitato P49W rovere naturale /  
metal P94 matt optic white /  
melamine P49W natural oak  
**Alchemia CB1056** sedia | chair  
polipropilene P94 bianco ottico opaco  
polypropylene P94 matt optic white





Planet CB4005-FD tavolo fisso | *non-extending table*  
metallo P15 nero opaco / vetro temprato GTR trasparente  
*metal P15 matt black / tempered glass GTR transparent*

Planet CB4005-FD  
tavolo fisso | *non-extending table*  
metallo P15 nero opaco /  
nobilitato P60W termocotto  
*metal P15 matt black /*  
*melamine P60W termocotto*  
Caffè CB1970 sedia | *chair*  
polipropilene P15 nero opaco  
*polypropylene P15 matt black*



# Royal

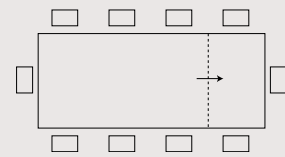
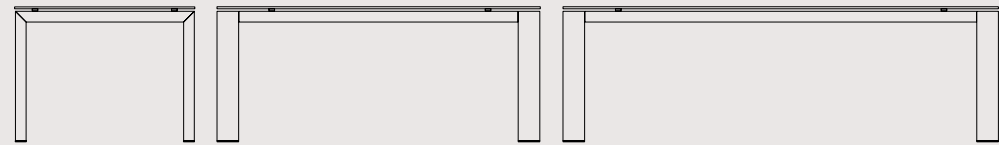

CB4082-MV 180 | 180(240)x100 cm

## gambe legs

metallo | *metal*



P74

## piano top

ceramica | *ceramic*



P133

P166

P321

P1C

**EASY**  
x-tension

ALLUNGA SEMI-AUTOMATICA tavolo allungabile con meccanismo semi automatico; le allunghe vengono posizionate agevolmente traslando su apposite guide.  
*SEMI-AUTOMATIC EXTENSION extendable table with semi-automatic mechanism; the extensions are easily aligned with the top by gliding on special runners.*

NOTA per le combinazioni disponibili consultare il listino prezzi. | *NOTE please check all available combinations in the price list.*

tavoli fissi e allungabili | *extending and non-extending tables*

**Royal CB4082-MV 180**  
tavolo allungabile | *extending table*  
alluminio P74 alluminio lucido /  
ceramica P166 nocciola  
*aluminium P74 polished aluminium /*  
*ceramic P166 nougat*

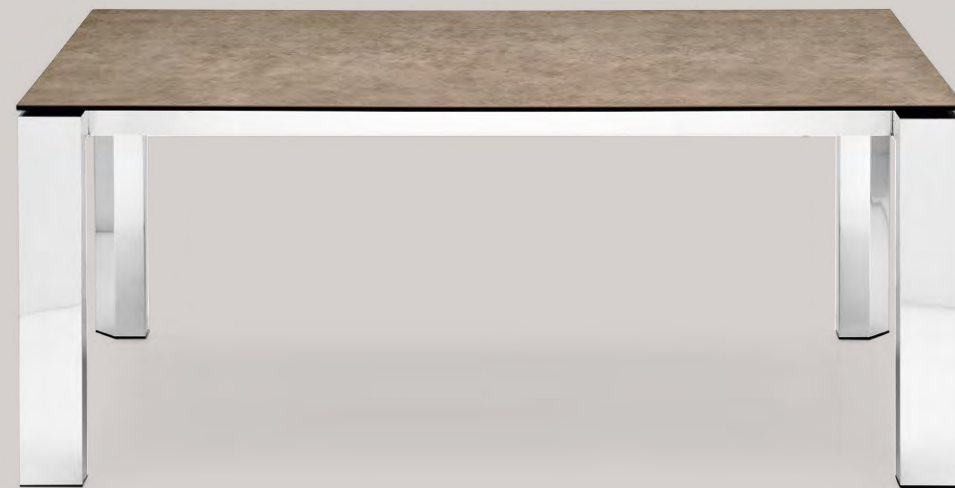

# Sigma

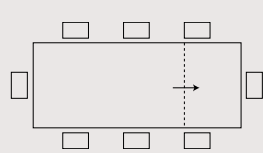
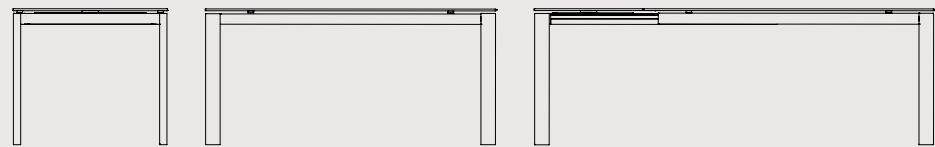

CB4069-R 160 | 160(220)x90 cm

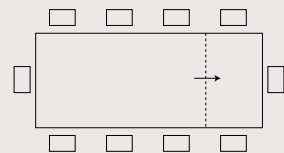

CB4069-R 180 | 180(240)x100 cm

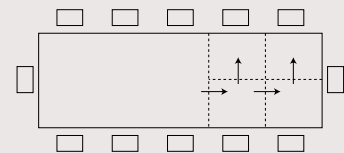

CB4069-RX 180 | 180(240)(300)x100 cm

## gambe legs

legno | wood



## piano top

legno | wood

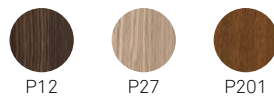

ceramica | ceramic



vetro | glass



NOTA per le combinazioni disponibili consultare il listino prezzi. | NOTE please check all available combinations in the price list.

**Sigma CB4069-R**  
tavolo allungabile | *extending table*  
legno P27 natural / ceramica P166 nocciola  
wood P27 natural / ceramic P166 nougat



Sigma

Sigma CB4069-R tavolo allungabile | *extending table*  
legno P201 noce / legno P201 noce  
wood P201 walnut / wood P201 walnut



tavoli fissi e allungabili | *extending and non-extending tables*

EASY  
x-tension

ALLUNGA SEMI-AUTOMATICA tavolo allungabile con meccanismo semi automatico; le allunghe vengono posizionate agevolmente traslando su apposite guide.  
SEMI-AUTOMATIC EXTENSION extendable table with semi-automatic mechanism; the extensions are easily aligned with the top by gliding on special runners.



1



2



3



4

**Sigma** CB4069-R tavolo allungabile | *extending table*  
legno P12 smoke / *ceramica P5C sale*  
*wood P12 smoke / ceramic P5C salt white*  
**Rosie Soft** CB1901 sedia | *chair*  
metallo P15 nero opaco / *similpelle Vintage S0X canapa*  
*metal P15 matt black / Vintage faux leather S0X hemp*





# Sincro

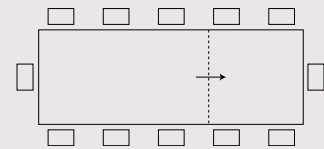
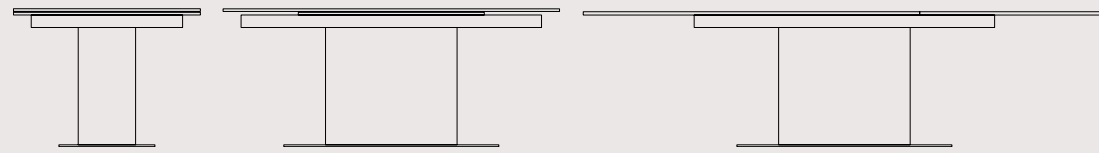

CB4087 | 180(280)x100 cm

## colonna column

legno | wood

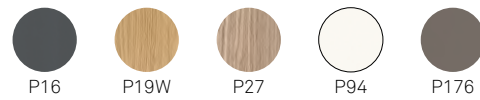

## cassonetto/piastra frame/floor plate

metallo | metal



## piano top

ceramica | ceramic



MAGIC  
x-tension

tavoli fissi e allungabili | extending and non-extending tables

**Sincro CB4087**  
tavolo allungabile | *extending table*  
laccato P176 tortora opaco /  
metallo P95 acciaio satinato /  
ceramica P321 piombo  
*lacquered P176 matt taupe /*  
*metal P95 satin finished steel /*  
*ceramic P321 lead grey*



Sincro

MAGIC  
x-tension

ALLUNGA AUTOMATICA tavolo allungabile con meccanismo automatico; le allunghe si posizionano autonomamente all'altezza del piano principale.  
AUTOMATIC EXTENSION extendable table with automatic mechanism; the extensions will automatically align with the top.



Sincro CB4087 tavolo allungabile | *extending table*  
laccato P176 tortora opaco / metallo P95 acciaio satinato / ceramica P321 piombo  
lacquered P176 matt taupe / metal P95 satin finished steel / ceramic P321 lead grey

tavoli fissi e allungabili | *extending and non-extending tables*

Sincro CB4087  
tavolo allungabile | *extending table*  
laccato P94 bianco ottico opaco -  
metallo P95 acciaio satinato /  
ceramica P117 bianco  
lacquered P94 matt optic white -  
metal P95 satin finished steel /  
ceramic P117 white



# Snap

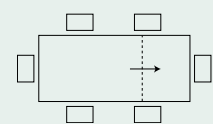
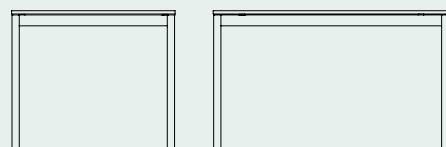

CB4085-R 110 | 110(160)x70 cm

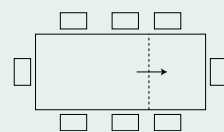

CB4085-R 120 | 120(180)x80 cm

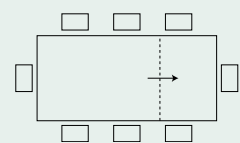

CB4085-R 130 | 130(190)x90 cm

## gambe legs

metallo | *metal*

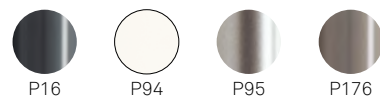

## piano top

vetro | *glass*

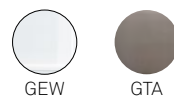

nobilitato | *melamine*

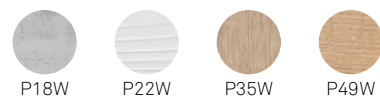

PIANI IN VETRO CON ALLUNGHE IN NOBILITATO - PIANI IN NOBILITATO CON ALLUNGHE NELLA STESSA FINITURA |  
GLASS TOPS AND MELAMINE EXTENSIONS - MELAMINE TOPS AND EXTENSIONS IN THE SAME FINISH

MANUAL  
x-tension

NOTA per le combinazioni disponibili consultare il listino prezzi. | NOTE please check all available combinations in the price list.

Snap CB4085-R tavolo allungabile | *extending table*  
metallo P176 tortora opaco / nobilitato P35W vintage  
*metal P176 matt taupe / melamine P35W vintage*



Snap

MANUAL  
x-tension

ALLUNGA MANUALE tavolo allungabile con meccanismo manuale; le allunghe vengono sollevate e posizionate all'altezza del piano principale.  
MANUAL EXTENSION extendable table with manual mechanism; the extensions are manually lifted and aligned with the top.

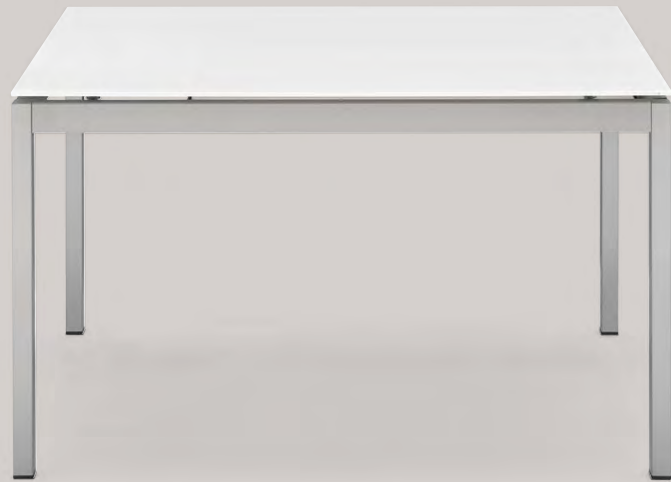

Snap CB4085-R 120 tavolo allungabile | *extending table*  
metallo P95 acciaio satinato / vetro temprato GEW serigrafato extrachiaro  
metal P95 satin finished steel / tempered glass GEW frosted extraclear

tavoli fissi e allungabili | *extending and non-extending tables*

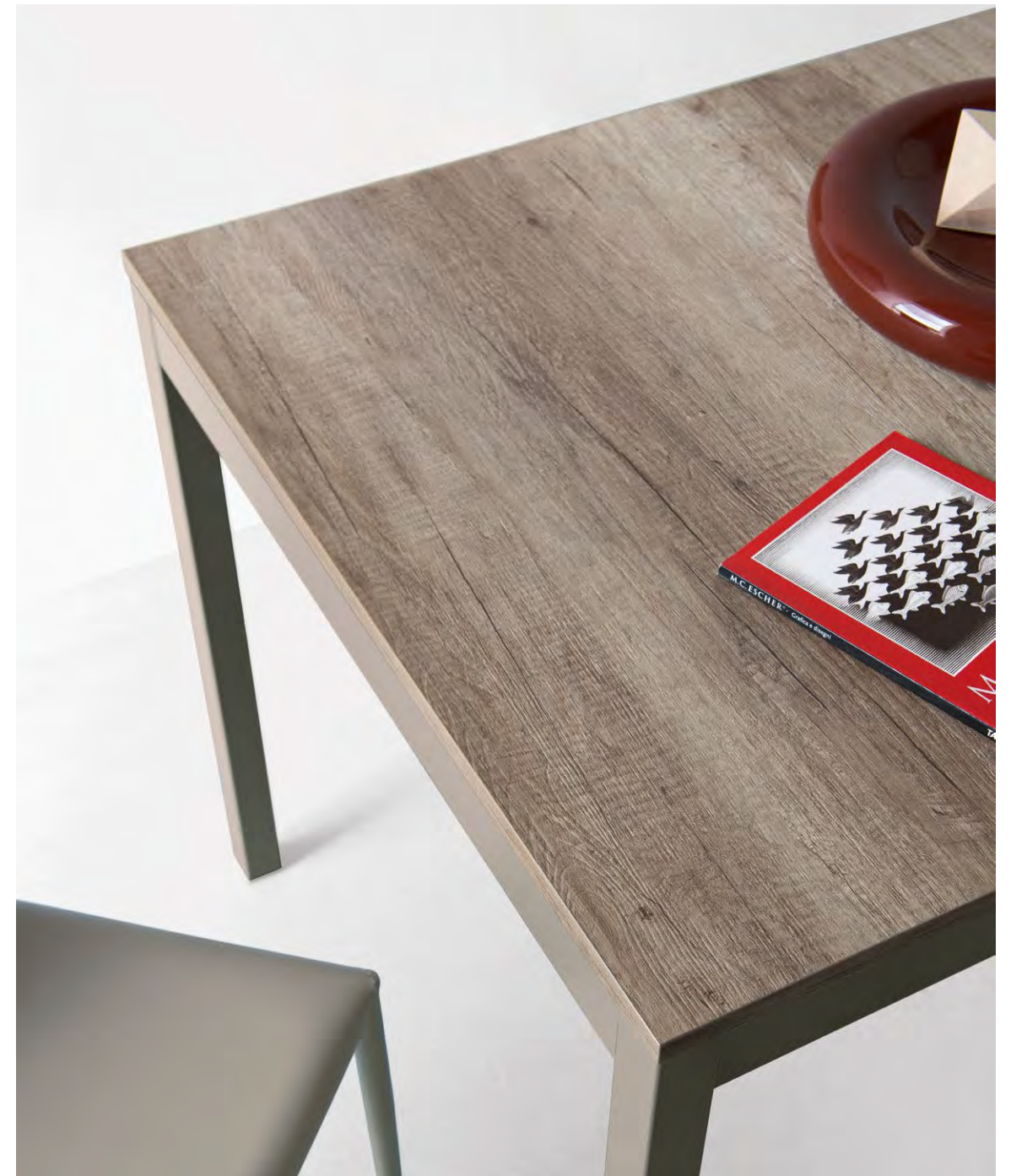

Snap CB4085-R tavolo allungabile | *extending table*  
metallo P176 tortora opaco / nobilitato P35W vintage  
metal P176 matt taupe / melamine P35W vintage

Snap CB4085-R tavolo allungabile | *extending table*  
metallo P16 grigio opaco / nobilitato P18W beton grigio  
*metal P16 matt grey / melamine P18W beton grey*  
Boheme CB1257 sedia | *chair*  
metallo P16 grigio opaco / rigenerato di cuoio R16 grigio  
*metal P16 matt grey / regenerated leather R16 grey*



# Stecco / home selection

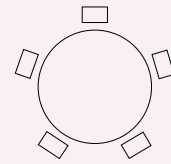
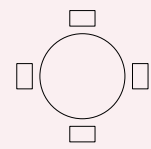
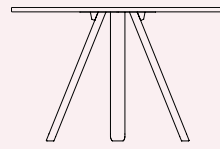
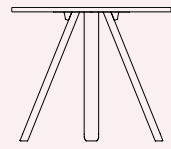

CB4793-FD 90 | Ø 90 cm

CB4793-FD 120 | Ø 120 cm

## basamento base

legno | wood

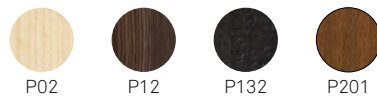

## piano top

laccato | lacquered



nobilitato | melamine

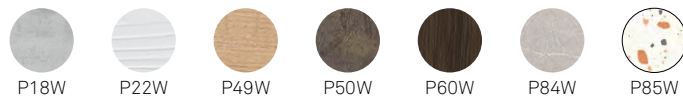

laminato | laminate

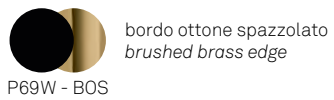

laminato stratificato |  
multilayer laminate



## tavoli fissi e allungabili | extending and non-extending tables

**Stecco** CB4793-FD 120  
tavolo fisso | *non-extending table*  
faggio P02 faggio sbiancato /  
piano in laminato P94 bianco ottico opaco  
*beech P02 bleached beechwood /*  
*laminated surface - P94 matt optic white*  
**Academy** CB1665 sedia | *chair*  
faggio P02 faggio sbiancato /  
polipropilene P94 bianco ottico opaco  
*beech P02 bleached beechwood /*  
*polypropylene P94 matt optic white*



# Wings

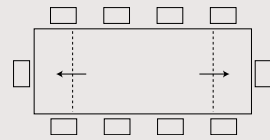
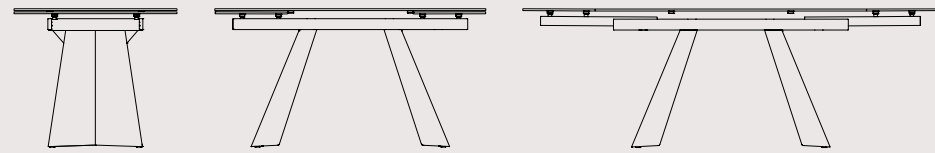

CB4801-R 150 | 150(190)(230)x90 cm

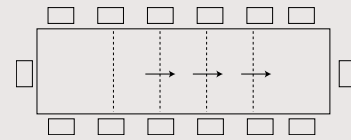

CB4796-R 160 | 160(210)(260)(310)x90 cm

tavoli fissi e allungabili | extending and non-extending tables

Wings CB4801-R 160 tavolo allungabile | *extending table*  
 metallo P15 nero opaco / nobilitato P50W bronzo ossido  
 metal P15 matt black / melamine P50W oxide bronze



## basamento base

metallo | *metal*

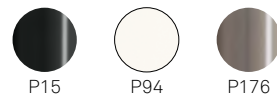

## piano top

ceramica | *ceramic*



nobilitato | *melamine*



EASY  
x-tension

MANUAL  
x-tension

NOTA per le combinazioni disponibili consultare il listino prezzi. | *NOTE please check all available combinations in the price list.*

MANUAL  
x-tension

ALLUNGA MANUALE tavolo allungabile con meccanismo manuale; le allunghe vengono sollevate e posizionate all'altezza del piano principale.  
MANUAL EXTENSION extendable table with manual mechanism; the extensions are manually lifted and aligned with the top.



Wings CB4801-R 160 tavolo allungabile | *extending table*  
 metallo P94 bianco ottico opaco / nobilitato P49W rovere naturale  
 metal P94 matt optic white / melamine P49W natural oak  
 Maya CB1914 sedia | *chair*  
 frassino P19W rovere naturale / similpelle Vintage S0A deserto  
 ashwood P19W natural oak / Vintage faux leather S0A desert



## Wings

EASY  
x-tension

ALLUNGA SEMI-AUTOMATICA tavolo allungabile con meccanismo semi automatico; le allunghe vengono posizionate agevolmente traslando su apposite guide.

SEMI-AUTOMATIC EXTENSION extendable table with semi-automatic mechanism; the extensions are easily aligned with the top by gliding on special runners.



**Wings CB4801-R 150** tavolo allungabile | *extending table*  
metallo P176 tortora opaco / ceramica P321 piombo  
*metal P176 matt taupe / ceramic P321 lead grey*

## tavoli fissi e allungabili | extending and non-extending tables



**Wings CB4801-R 150** tavolo allungabile | *extending table*  
metallo P15 nero opaco / ceramica P6C ossido nero  
*metal P15 matt black / ceramic P6C black oxide*

# Zeffiro

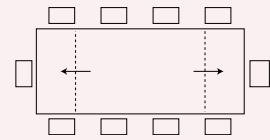
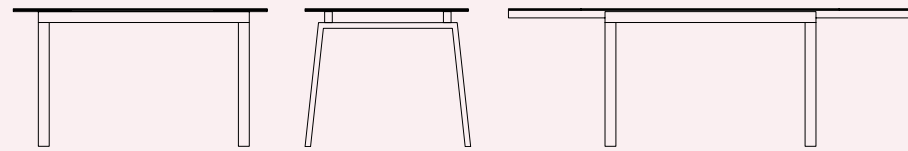

CB4798-R 140 | 140(180)(220)x90 cm

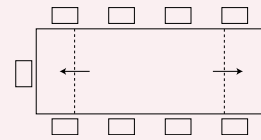

CB4798-R 160 | 160(200)(240)x90 cm

## gambe legs

metallo | metal



legno | wood



## guide rails

metallo | metal



## piano top

ceramica | ceramic

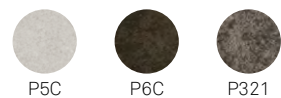

vetro | glass



NOTA per le combinazioni disponibili consultare il listino prezzi. | NOTE please check all available combinations in the price list.

tavoli fissi e allungabili | extending and non-extending tables

Zeffiro CB4798-R tavolo allungabile | extending table  
 metallo P15 nero opaco / metallo P15 nero opaco /  
 vetro temprato GTR trasparente  
 metal P15 matt black / metal P15 matt black /  
 tempered glass GTR transparent



EASY  
x-tension

ALLUNGA SEMI-AUTOMATICA tavolo allungabile con meccanismo semi automatico; le allunghe vengono posizionate agevolmente traslando su apposite guide.

SEMI-AUTOMATIC EXTENSION extendable table with semi-automatic mechanism; the extensions are easily aligned with the top by gliding on special runners.



Zeffiro CB4798-R 160 tavolo allungabile | *extending table*  
metallo P176 tortora opaco / ceramica P321 piombo  
metal P176 matt taupe / ceramic P321 lead grey

Zeffiro CB4798-R 160 tavolo allungabile | *extending table*  
metallo P176 tortora opaco / ceramica P321 piombo  
metal P176 matt taupe / ceramic P321 lead grey



Zeffiro CB4798-R  
 tavolo allungabile | *extending table*  
 faggio P02 faggio sbiancato -  
 metallo P3L rosso ossido opaco /  
 vetro temprato GTR trasparente  
*beech P02 bleached beechwood -*  
*metal P3L matt oxide red /*  
*tempered glass GTR transparent*  
 Academy CB1665 sedia | *chair*  
 faggio P02 faggio sbiancato /  
 polipropilene P3L rosso ossido opaco  
*beech P02 bleached beechwood /*  
*polypropylene P3L matt oxide red*

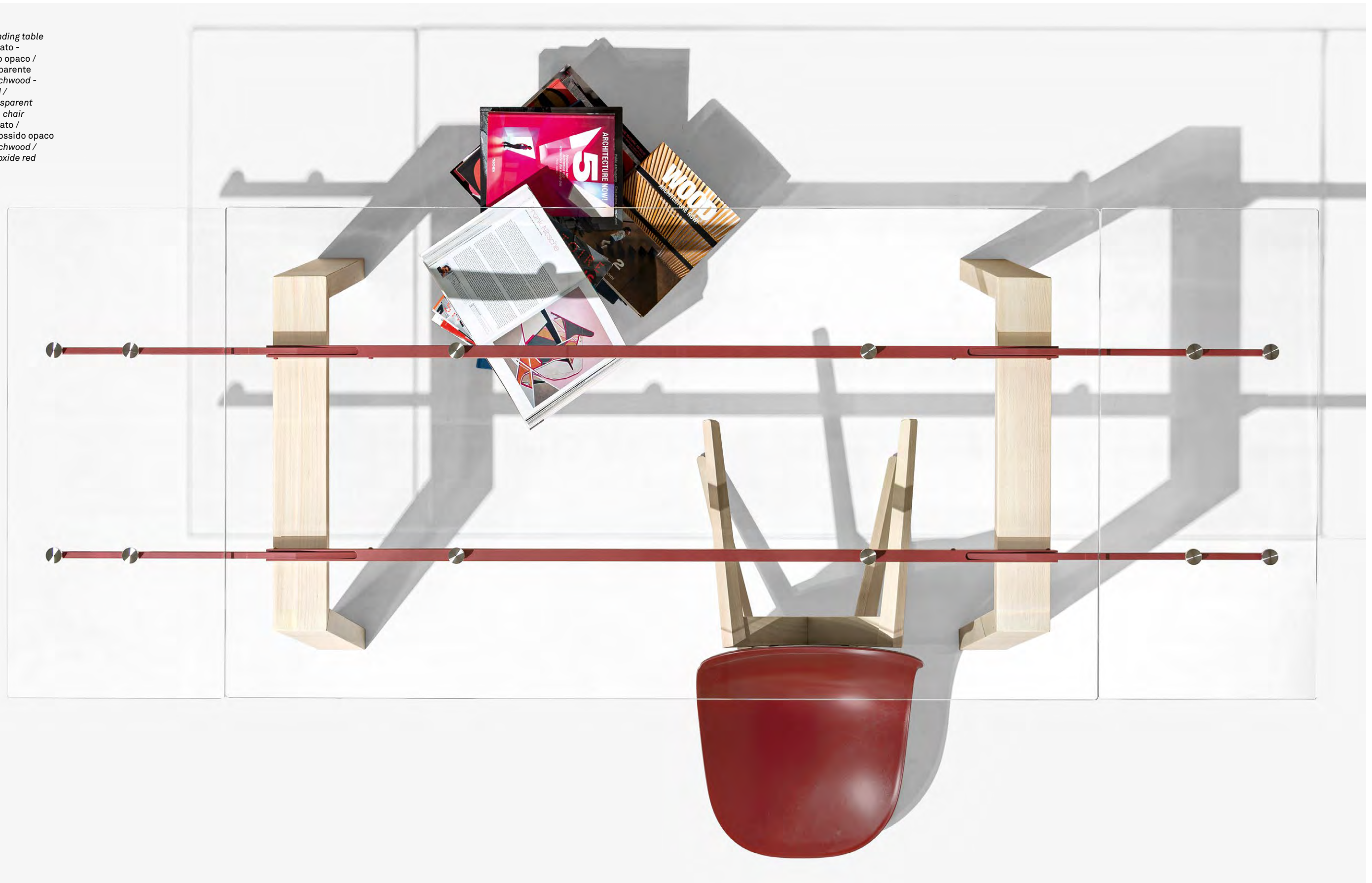

# Tavoli Contract | Contract Tables

## Branch/Cocktail/Stecco

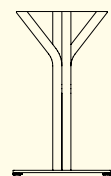

Branch CB4794-B 43

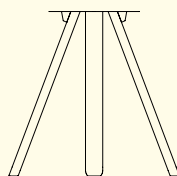

Stecco CB4793-B 30

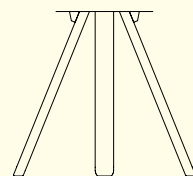

Stecco CB4793-B 40



Cocktail CB4761-B 48

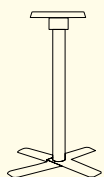

Cocktail CB4786-B 48

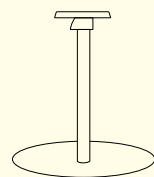

Cocktail CB4759-B 74

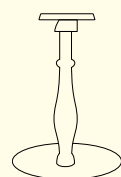

Cocktail CB4787-B 56

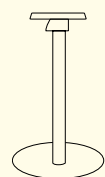

Cocktail CB4759-B 40

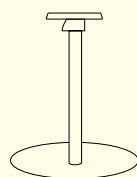

Cocktail CB4759-B 56

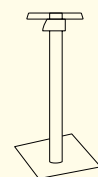

Cocktail CB4760-B 40

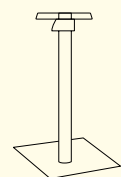

Cocktail CB4760-B 55

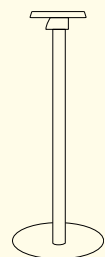

Cocktail CB4759-A 40

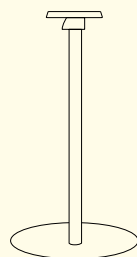

Cocktail CB4759-A 56

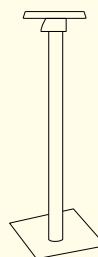

Cocktail CB4760-A 40

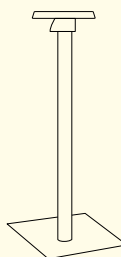

Cocktail CB4760-A 55

### piastra base

metallo | metal

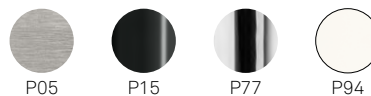

versione cromata non adatta ad uso esterno |  
outdoor use except for chromed version

### colonna column

metallo | metal

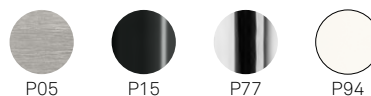

versione cromata non adatta ad uso esterno |  
outdoor use except for chromed version

legno | wood



NOTA per le combinazioni disponibili consultare il listino prezzi. | NOTE please check all available combinations in the price list.

**Cocktail CB4759-B 40 - CB4715-D90LQ**  
tavolo fisso | non-extending table  
metallo P15 nero opaco /  
P69W/BOS nero / ottone spazzolato  
metal P15 matt black /  
P69W/BOS black / brushed brass  
**Academy CB1663 sedia** | chair  
metallo P33L ottone verniciato /  
tessuto Mat SLL limone  
metal P33L Painted Brass /  
Mat fabric SLL lemon yellow



**Cocktail** CB4760-B 55 basamento | *table base*  
 metallo P15 nero opaco / *metal P15 matt black* /  
**Cocktail** CB4764-Q80BK piano | *top*  
 laminato (hpl) con anima nera P421-BNE nero /  
*laminato (hpl) with black core P421-BNE black*  
**Academy** CB1663 sedia | *chair*  
 P15 nero opaco / *similpelle Ekos G8N nero*  
 P15 matt black / *Ekos faux leather G8N black*

**Cocktail** CB4759-B 40 basamento | *table base*  
 metallo P94 bianco ottico opaco  
*metal P94 matt optic white*  
**Cocktail** CB4762-D70BK piano | *top*  
 laminato (hpl) con anima nera  
 P94-BNE bianco ottico opaco  
*laminato (hpl) with black core*  
 P94-BNE matt optic white  
**Academy** CB1664 sedia | *chair*  
 metallo P94 bianco ottico opaco /  
 polipropilene P94 bianco ottico opaco  
*metal P94 matt optic white /*  
*polypropylene P94 matt optic white*



Branch/Cocktail/Stecco



Branch CB4794-B 43  
43x43 H72,5 cm  
adatta per piani di  $\varnothing$  da 60 a 90 cm,  
oppure da 60x60 a 80x80 cm |  
suitable for top sizes:  $\varnothing$  from 60  
to 90 cm, or from 60x60 to 80x80 cm



Stecco CB4793-B 30  
60x60 H72,5 cm  
adatta per piani di  $\varnothing$  da 60 a 100 cm,  
oppure da 60x60 a 90x90 cm |  
suitable for top sizes:  $\varnothing$  from 60  
to 100 cm, or from 60x60 to 90x90 cm



Stecco CB4793-B 40  
68,5x68,5 H72,5 cm  
adatta per piani di  $\varnothing$  da 120 a 130 cm |  
suitable for top sizes:  $\varnothing$  from 120  
to 130 cm



Cocktail CB4761-B 48  
48x48 H73 cm  
adatta per piani di  $\varnothing$  da 60 a 90 cm,  
oppure da 60x60 a 90x90 cm | suitable  
for top sizes:  $\varnothing$  from 60 to 90 cm, or  
from 60x60 to 90x90 cm



Cocktail CB4786-B 48  
48x48 H73 cm  
adatta per piani di  $\varnothing$  da 60 a 90 cm,  
oppure da 60x60 a 90x90 cm | suitable  
for top sizes:  $\varnothing$  from 60 to 90 cm, or from  
60x60 to 90x90 cm



Cocktail CB4759-B 74  
 $\varnothing$  74 H73 cm  
adatta per piani di  $\varnothing$  da 120 a 130  
cm, oppure da 80x80 a 100x100 cm |  
suitable for top sizes:  $\varnothing$  from 120 to 130  
cm, or from 80x80 to 100x100 cm



Cocktail CB4787-B 56  
 $\varnothing$  55 H73 cm  
adatta per piani di  $\varnothing$  da 60 a 100 cm,  
oppure da 60x60 a 70x70 cm |  
suitable for top sizes:  $\varnothing$  from 60  
to 100 cm, or from 60x60 to 70x70 cm



Cocktail CB4759-B 40  
 $\varnothing$  40 H73 cm  
adatta per piani di  $\varnothing$  da 60 a 70 cm |  
suitable for top sizes:  
 $\varnothing$  from 60 to 70 cm



Cocktail CB4759-B 56  
 $\varnothing$  56 H73 cm  
adatta per piani di  $\varnothing$  da 60 a 100 cm,  
oppure da 60x60 a 70x70 cm | suitable  
for top sizes:  $\varnothing$  from 60 to 100 cm, or  
from 60x60 to 70x70 cm



Cocktail CB4760-B 40  
40x40 H73 cm  
adatta per piani di  $\varnothing$  da 60 a 80 cm,  
oppure da 60x60 a 80x80 cm |  
suitable for top sizes:  $\varnothing$  from 60  
to 80 cm, or from 60x60 to 80x80 cm



Cocktail CB4760-B 55  
55x55 H73 cm  
adatta per piani di  $\varnothing$  da 60 a 120 cm, op-  
pure da 60x60 a 100x100, o 120x80 cm |  
suitable for top sizes:  $\varnothing$  from 60 to 120 cm,  
or from 60x60 to 100x100, or 120x80 cm



Cocktail CB4759-A 40  
 $\varnothing$  40 H109 cm  
adatta per piani di dimensione:  
 $\varnothing$  da 60 a 70 cm | suitable for top  
sizes:  $\varnothing$  from 60 to 70 cm



Cocktail CB4759-A 56  
 $\varnothing$  56 H109 cm  
adatta per piani di dimensione:  $\varnothing$  da 60  
a 100 cm, oppure da 60x60 a 70x70 cm  
| suitable for top sizes:  $\varnothing$  from 60  
to 100 cm, or from 60x60 to 70x70 cm



Cocktail CB4760-A 40  
40x40 H109 cm  
adatta per piani di dimensione:  $\varnothing$  da 60  
a 70 cm, oppure da 60x60 a 70x70 cm |  
suitable for top sizes:  $\varnothing$  from 60  
to 70 cm, or from 60x60 to 70x70 cm



Cocktail CB4760-A 55  
55x55 H109 cm  
adatta per piani di dimensione:  $\varnothing$  da 60  
a 100 cm, oppure da 60x60 a 80x80 cm  
| suitable for top sizes:  $\varnothing$  from 60  
to 100 cm, or from 60x60 to 80x80 cm

tavoli contract | contract tables

Branch CB4794-B 43 basamento | table base  
faggio P132 grafite / metallo P15 nero opaco  
beech P132 graphite / metal P15 matt black  
Cocktail CB4762-Q80BK piano | top  
laminato stratificato (hpl) con anima nera P510 ardesia  
stratified laminate (hpl) with black core P510 slate grey  
Academy CB1665 sedia | chair  
faggio P132 grafite / similpelle Ekos G8N nero |  
beech P132 graphite / Ekos faux leather G8N black

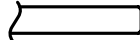

**Piani in laminato 3 cm**  
Laminated tops 3 cm

Bordo verticale | Straight edge - 3 cm 

CB4716 | 59x59 / 69x69 / 79x79 / 89x89 / 119x79 cm



CB4715 | Ø59 / Ø69 / Ø79 / Ø89 / Ø99 / Ø119 / Ø129

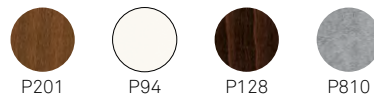

**Piani in nobilitato**  
Melamine Tops

Bordo inclinato esterno | Externally bevelled edge - 3,5 cm 

CB4716 | 70x70 / 80x80 cm

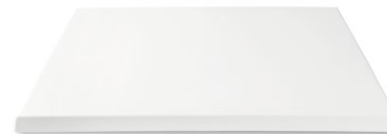

**Piani in laminato 5 cm**  
Laminated tops 5 cm

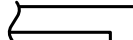
Bordo verticale | Straight edge - 5 cm 

CB4712 | 59x59 / 69x69 / 79x79 / 89x89 / 119x79 cm



**Piani in nobilitato**  
Melamine Tops

Bordo inclinato esterno | Externally bevelled edge - 2,5 cm 

CB4715 | Ø60 cm



Stecco CB4793-FD 120 basamento | table base  
faggio P02 faggio sbiancato  
beech P02 bleached beechwood  
Cocktail CB4715-D120L piano | top  
piano in laminato P94 bianco ottico opaco  
lamine P94 matt optic white  
Academy CB1665 sedia | chair  
faggio P02 faggio sbiancato /  
polipropilene P94 bianco ottico opaco  
beech P02 bleached beechwood /  
polypropylene P94 matt optic white





**Piani in laminato stratificato HPL (BK anima nera)**  
*HPL multilayer laminate tops (BK black core)*

Bordo inclinato interno a 45° |  
 45° internally bevelled edge - 1 cm

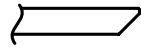

**CB4764** | 59x59 / 69x69 / 79x79 / 89x89 / 99x99 / 119x79 cm



**Piani in laminato stratificato HPL (FC Full Color)**  
*HPL multilayer laminate tops (FC Full Color)*

Bordo inclinato interno a 45° |  
 45° internally bevelled edge - 1 cm

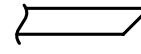

**CB4764** | 59x59 / 69x69 / 79x79 / 89x89 / 99x99 / 119x79 cm

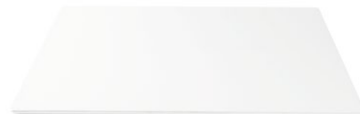

Bordo arrotondato | *Rounded edge* - 1 cm

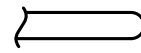

**CB4763** | Ø59 / Ø69 / Ø79 / Ø89 cm



**Piani in laminato stratificato HPL**  
*HPL multilayer laminate tops*

Bordo verticale | *Straight edge* - 1 cm

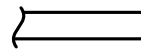

**CB4762** | 59x59 / 69x69 / 79x79 / 89x89 / 99x99 / 119x79 cm



**CB4762** | Ø59 / Ø69 / Ø79 / Ø89 / Ø99 / Ø119 / Ø129 cm



**Piani lucidi HR LAQ2**  
*Glossy tops HR LAQ2*

Bordo verticale | *Straight edge* - 3 cm

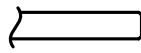

**CB4716** | 69x69 / 79x79 / 89x89 cm  
**CB4715** | Ø69 / Ø79 / Ø89 / Ø119 / Ø129 cm

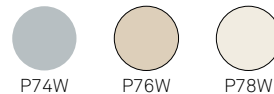

**Branch** CB4794-B 43 basamento | *table base*  
 faggio P132 grafite / metallo P15 nero opaco  
 beech P132 graphite / metal P15 matt black  
**Cocktail** CB4762-Q80BK piano | *top laminato stratificato (hpl) con anima nera P510 ardesia stratified laminate (hpl) with black core P510 slate grey*  
**Academy** CB1665 sedia | *chair*  
 faggio P132 grafite / similpelle Ekos G8N nero  
 beech P132 graphite / Ekos faux leather G8N black



NOTA per le combinazioni disponibili consultare il listino prezzi. | NOTE please check all available combinations in the price list.

**Cocktail** CB4760-A 55 P94  
basamento | table base  
metallo P94 bianco ottico opaco  
metal P94 matt optic white  
**Cocktail** CB4716-Q 80L piano | top  
laminato P19W rovere naturale  
lamine P19W natural oak  
**Academy** CB1673 sgabello | stool  
frassino P19W rovere naturale /  
polipropilene P94 bianco ottico opaco  
ashwood P19W natural oak /  
polypropylene P94 matt optic white



**Cocktail** CB4759-A 56  
basamento | table base  
metallo P15 nero opaco  
metal P15 matt black  
**Cocktail** CB4762-D80BK piano | top  
laminato HPL P421-BNE nero  
lamine HPL P421-BNE black  
**Academy** CB1675 sgabello | stool  
P15 nero opaco /  
similpelle Ekos G8N nero  
P15 matt black /  
Ekos faux leather G8N black



# Eminence Consolle

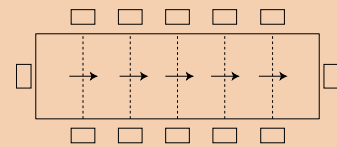
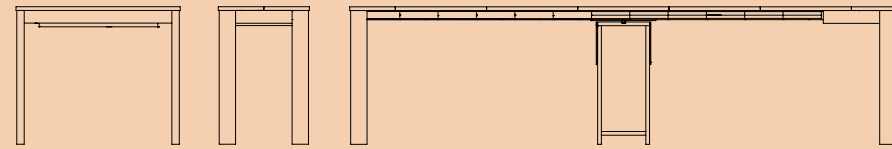

CB4724-RC 50 | 50(100)(150)(200)(250)(300)x90 cm

## gambe legs

legno | wood



## piano top

nobilitato | melamine



MANUAL  
x-tension

ALLUNGA MANUALE tavolo allungabile con meccanismo manuale; le allunghe vengono sollevate e posizionate all'altezza del piano principale.

MANUAL EXTENSION extendable table with manual mechanism; the extensions are manually lifted and aligned with the top.



NOTA per le combinazioni disponibili consultare il listino prezzi. | NOTE please check all available combinations in the price list.



Eminence Consolle CB4724-RC 50 consolle allungabile | extending console  
faggio P15 nero opaco / nobilitato P50W bronzo ossido  
beech P15 matt black / melamine P50W oxide bronze

# Sigma Consolle

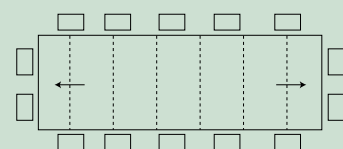
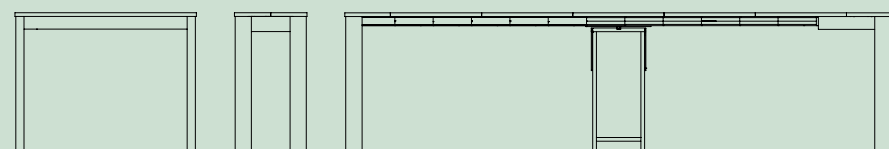

CB4069-RCX 49 | 49(99,5)(150)(200)(250)(300)x100 cm

consolle e tavoli pieghevoli / consoles and folding tables



## gambe/piano legs/top

legno | wood



P201

laccato | lacquered



P94



P176

ALLUNGHE IN NOBILITATO | MELAMINE EXTENSION



ALLUNGA MANUALE tavolo allungabile con meccanismo manuale; le allunghe vengono sollevate e posizionate all'altezza del piano principale.  
MANUAL EXTENSION extendable table with manual mechanism; the extensions are manually lifted and aligned with the top.



Sigma Consolle CB4069-RCX 49 consolle allungabile | extending console  
laccato P94 bianco ottico opaco / legno P94 bianco ottico opaco  
lacquered P94 matt optic white / P94 matt optic white

NOTA per le combinazioni disponibili consultare il listino prezzi. | NOTE please check all available combinations in the price list.

# Spazio

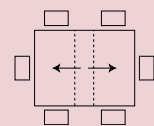
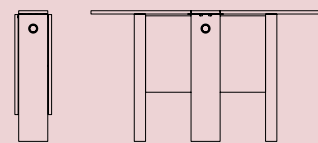

CB07 | 20(73)(126)x80 cm

## struttura/ piano frame/ top

nobilitato | melamine



P39



NOTA per le combinazioni disponibili consultare il listino prezzi. | NOTE please check all available combinations in the price list.

## consolle e tavoli pieghevoli / consoles and folding tables

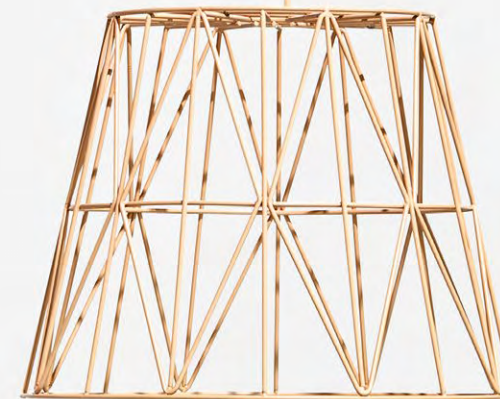

Spazio CB07 tavolo pieghevole | *folding table*  
nobilitato P39 bianco opaco  
*melamine P39 matt white*  
Academy CB1663 sedia | *chair*  
metallo P2L cipria opaco / tessuto Mat SLN rosa  
*metal P2L matt pink / Mat fabric SLN pink*



# Magic-J

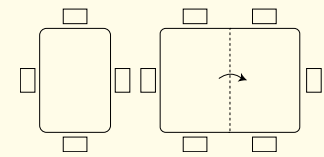
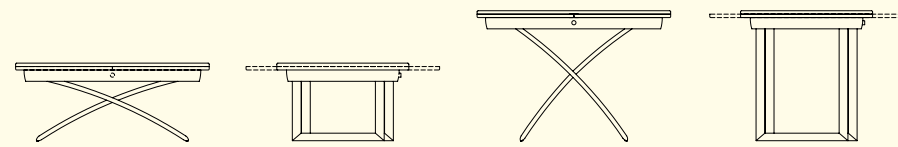

CB5041-W | 110x75(150) H74(34)(64) cm

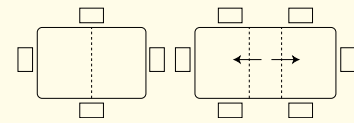

CB5041-G | 115(150)x75 H72(34)(64) cm

## basamento base

metallo | metal

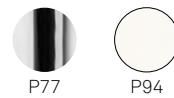

## piano top

legno | wood

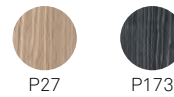

laccato | lacquered



vetro | glass



NOTA per le combinazioni disponibili consultare il listino prezzi. | NOTE please check all available combinations in the price list.



**Magic-J** CB5041-G tavolini trasformabili | multi-purpose table  
metallo P77 cromato / vetro temperato GB serigrafato nero  
metal P77 chromed / tempered glass GB frosted black

Magic-J

EASY  
x-tension

ALLUNGA SEMI-AUTOMATICA tavolo allungabile con meccanismo semi automatico; le allunghe vengono posizionate agevolmente traslando su apposite guide.

SEMI-AUTOMATIC EXTENSION extendable table with semi-automatic mechanism; the extensions are easily aligned with the top by gliding on special runners.



Magic-J CB5041-W tavolini trasformabili | multi-purpose table  
metallo P94 bianco ottico opaco / legno P27 natural  
metal P94 matt optic white / wood P27 natural

tavolini trasformabili | multi-purpose tables

Magic-J CB5041-W  
tavolini trasformabili | multi-purpose table  
metallo P94 bianco ottico opaco / legno P27 natural  
metal P94 matt optic white / wood P27 natural  
Gamera CB1459 sedia | chair  
nylon P94 bianco ottico opaco  
nylon P94 matt optic white



# Mascotte

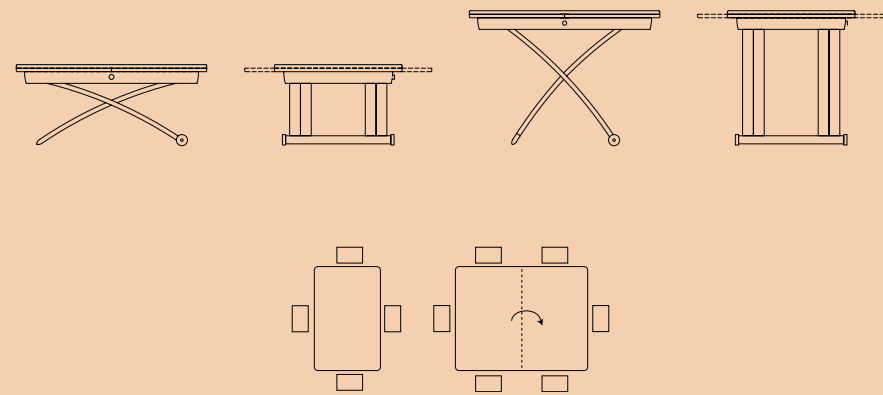

CB490 | 105x70(140) H74(32,5)(64,5) cm

## basamento base

legno | wood

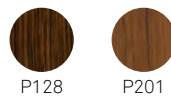

laccato | lacquered



## piano top

legno | wood

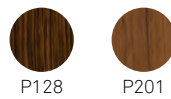

laccato | lacquered



NOTA per le combinazioni disponibili consultare il listino prezzi. | NOTE please check all available combinations in the price list.



**Mascotte** CB490 tavolini trasformabili | *multi-purpose table*  
laccato P94 bianco ottico opaco / legno P94 bianco ottico opaco  
lacquered P94 matt optic white / wood P94 matt optic white



EASY  
x-tension

ALLUNGA SEMI-AUTOMATICA tavolo allungabile con meccanismo semi automatico; le allunghe vengono posizionate agevolmente traslando su apposite guide.

SEMI-AUTOMATIC EXTENSION extendable table with semi-automatic mechanism; the extensions are easily aligned with the top by gliding on special runners.



**Mascotte CB490**  
tavolini trasformabili | *multi-purpose table*  
faggio P128 wengé / legno P128 wengé  
beech P128 wengé / wood P128 wengé

**Mascotte CB490** tavolini  
trasformabili | *multi-purpose table*  
laccato P94 bianco ottico opaco  
legno P94 bianco ottico opaco  
*lacquered P94 matt optic white*  
*wood P94 matt optic white*  
**Academy CB1665** sedia | *chair*  
faggio P94 bianco ottico opaco  
polipropilene P94 bianco ottico opaco  
*beech P94 matt optic white*  
*polypropylene P94 matt optic white*



# Islands

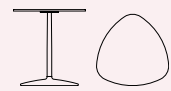

CB5061-A | 40x40 H42 cm

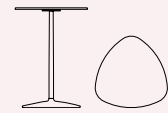

CB5061-B | 40x40 H55 cm

## colonna/piastra column/floor plate

laccato | lacquered



## piano top

laccato | lacquered



## tavolini fissi | coffee tables

Islands CB5061-A - CB5061-B  
tavolini fissi | coffee tables  
laccato P2L cipria opaco - P176 tortora opaco -  
P94 bianco ottico opaco - P3L rosso ossido opaco  
lacquered P2L matt pale pink - P176 matt taupe -  
P94 matt optic white - P3L matt oxide red



NOTA per le combinazioni disponibili consultare il listino prezzi. | NOTE please check all available combinations in the price list.

# Bubbles

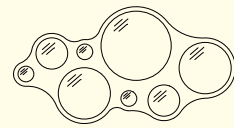

CB5029 | 98x51,5 cm

## struttura frame

laccato | lacquered

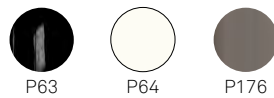

specchio | mirror



specchi | mirrors

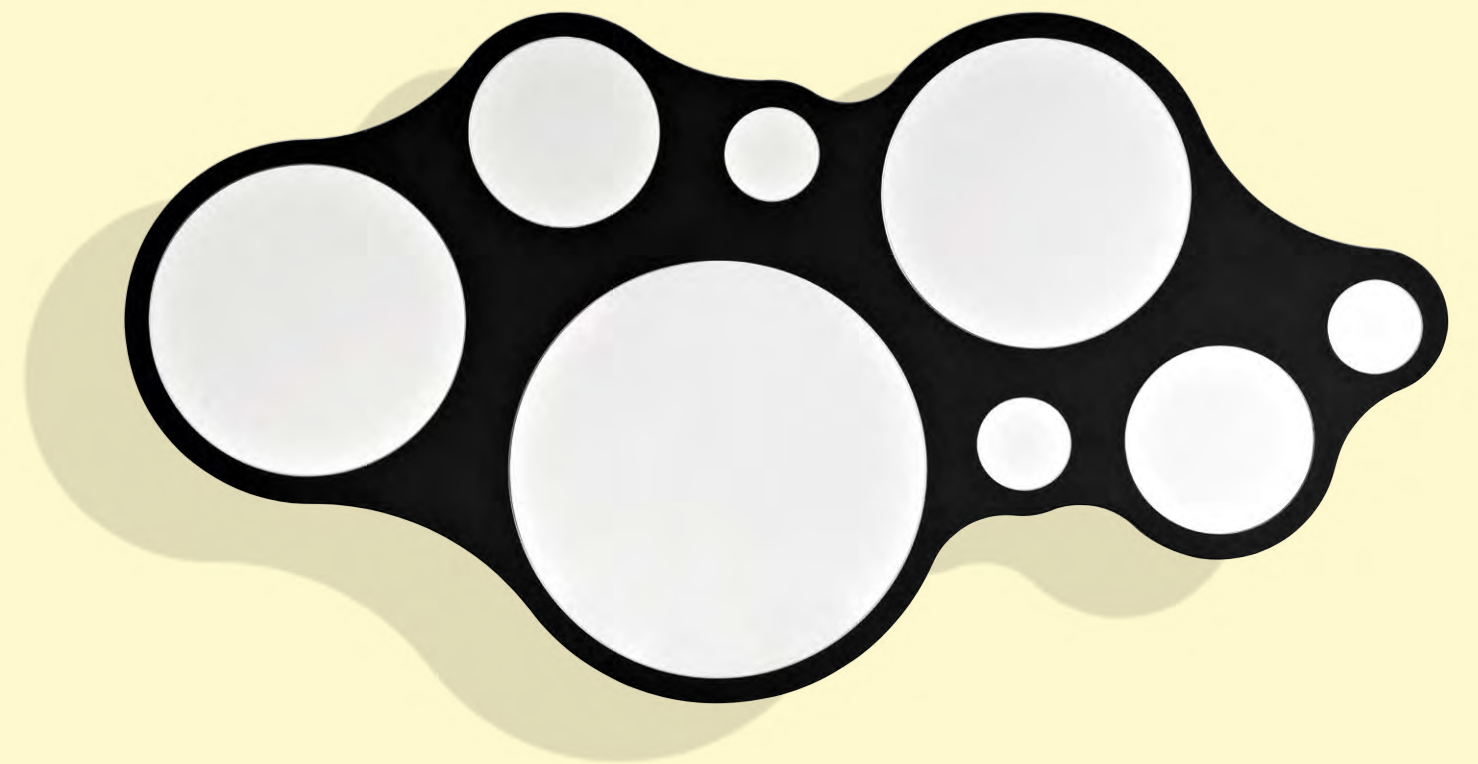

**Bubbles** CB5029 specchio | mirror  
laccato P63 mero lucido - specchio GMR  
lacquered P63 glossy black - mirror GMR

# Drop

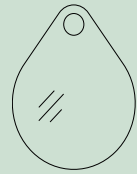

CB5034-P | 65x87 cm



CB5034-G | 60x154 cm

## struttura frame

laccato | lacquered



P64

specchio | mirror



GMR

specchi | mirrors

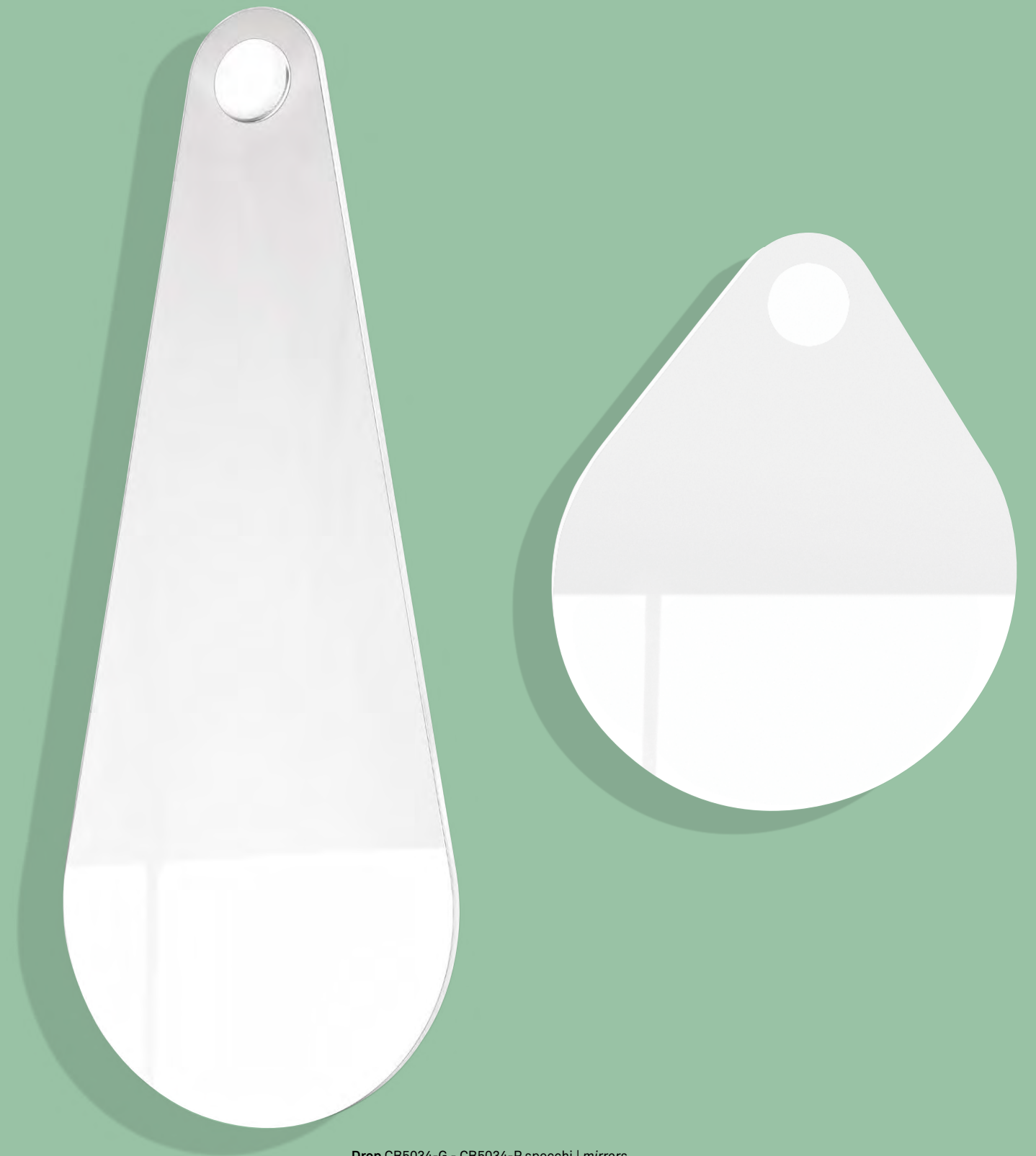

**Drop** CB5034-G - CB5034-P specchi | mirrors  
laccato P94 bianco ottico opaco - specchio GMR  
lacquered P94 matt optic white - mirror GMR

# Lune

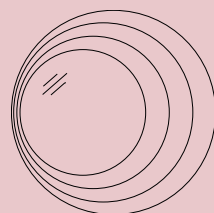

CB5074 | Ø 90 cm

## struttura frame

specchio | *mirror*



GMR

specchi | mirrors

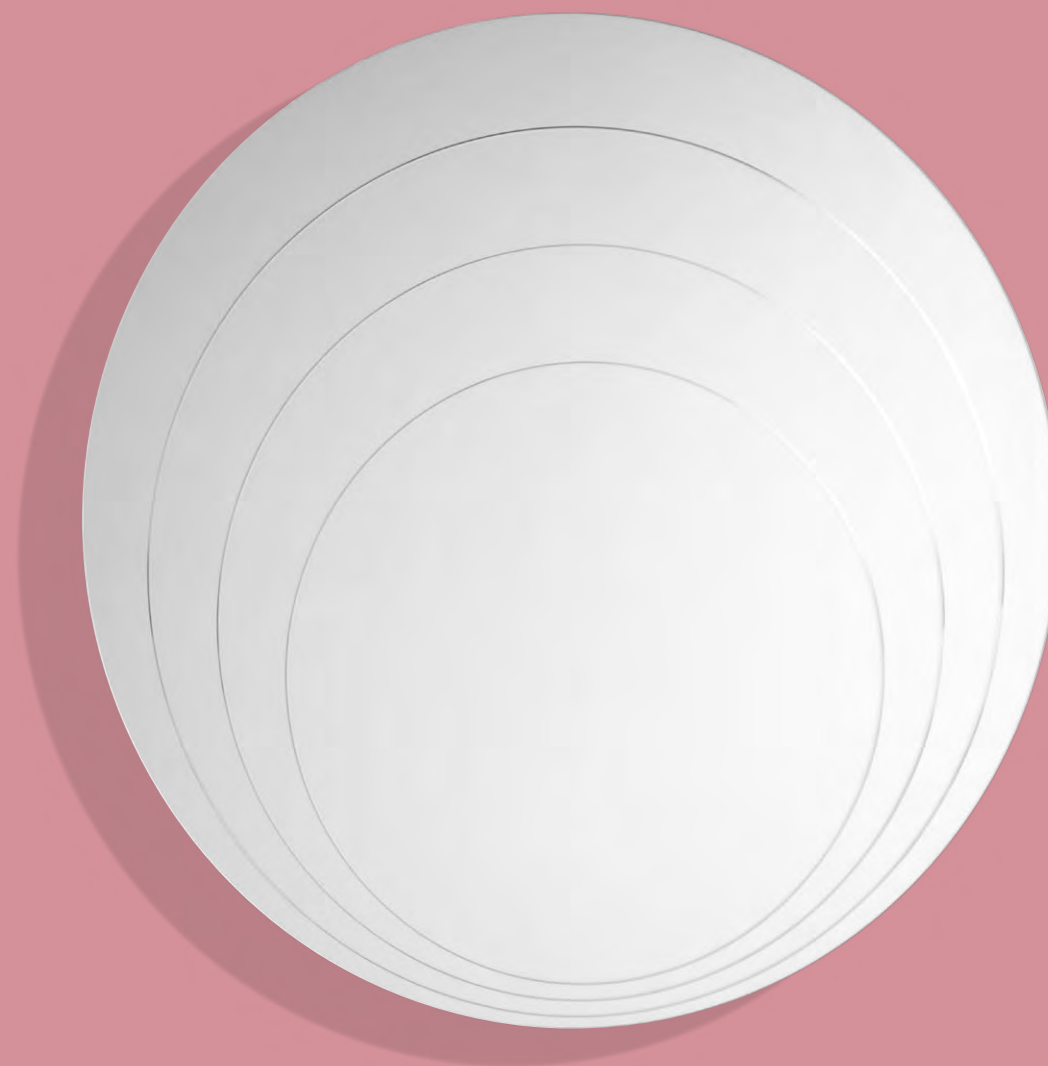

Lune CB5074 specchio | *mirror*  
specchio GMR  
*mirror GMR*

sgabelli  
stools



**ACADEMY**  
CB1672  
L47 P50 H106 HS66  
W18½" D19¾" H41¼" SH26"  
p. 182-197



**ACADEMY**  
CB1673  
L50 P50 H121 HS81  
W19¾" D19¾" H47¾" SH32"  
p. 182-197



**ACADEMY**  
CB1674  
L48 P55 H104 HS66  
W19" D21¼" H41" SH26"  
p. 182-197



**CLELIA**  
CB2123  
L40 P40 H68  
W15¼" W15¼" H26¾"  
p. 32-39



**CLELIA**  
CB2124  
L40 P40 H79  
W15¼" D15¼" H31½"  
p. 32-39



**CLELIA**  
CB2121  
L49 P54 H90 HS66  
W19¾" D21¾" H35½" SH26"  
p. 32-39



**CLELIA**  
CB2121-A  
L49 P54 H90 HS65  
W19¾" D21¾" H35½" SH25½"  
p. 32-39



**ACADEMY**  
CB1675  
L50 P53 H119 HS81  
W19¾" D20¾" H46¾" SH32"  
p. 182-197



**ACADEMY**  
CB1676  
L44 P49 H123(104) HS85(66)  
W17¾" D19¾" H48¼(41)" SH33¼(26)"  
p. 182-197



**ACE**  
CB1329  
L41,5 P48 H92 HS65  
W16¾" D19" H36¼" SH25½"  
p. 198-201



**ACE**  
CB1692  
L41,5 P48 H92 HS65  
W16¾" D19" H36¼" SH25½"  
p. 198-201



**CLELIA**  
CB2122  
L50 P55 H101 HS76  
W19¾" D21¼" H39¾" SH30"  
p. 32-39



**CLELIA**  
CB2122-A  
L50 P55 H101 HS75  
W19¾" D21¼" H39¾" SH29¾"  
p. 32-39



**CLIP**  
CB1975  
L45 P47,5 H91 HS66  
W17¾" D18¾" H35½" SH26"  
p. 234-237



**CLIP**  
CB1972  
L45 P47,5 H91 HS65  
W17¾" D18¾" H35½" SH25½"  
p. 234-237



**AIR**  
CB57  
L51 P53 H96,5 HS65  
W20¼" D20¾" H38" SH25¾"  
p. 202-203



**BAYO**  
CB1984  
L47 P46,5 H90 HS65  
W 8½" D18¾" H35½" SH25¾"  
p. 18-27



**BAYO**  
CB1985  
L47 P47 H101 HS76  
W18½" W18½" H39¾" SH30"  
p. 18-27



**BOHEME**  
CB1393  
L43 P49,5 H90 HS65  
W17" D19½" H35½" SH25¾"  
p. 224-227



**COSMOPOLITAN**  
CB1939  
L46,5 P46 H78 HS65  
W18¾" D18¾" H30¾" SH25¾"  
p. 244-247



**COSMOPOLITAN**  
CB1940  
L50 P50 H93 HS80  
W19¾" D19¾" H36¾" SH31½"  
p. 244-247



**COSMOPOLITAN**  
CB1941  
L47 P50 H76 HS65  
W18½" D19¾" H30" SH25¾"  
p. 244-247



**COSMOPOLITAN**  
CB1942  
L50 P50 H91,5 HS80  
W19¾" D19¾" H36¼" SH31½"  
p. 244-247



**COSMOPOLITAN**

CB1943  
L44 P43,5 H94(77) HS80(63)  
W17½" D17¼" H37½(30%) SH31¼(24½)"

p. 244-247



**COSMOPOLITAN**

CB1944  
L44 P42,5 H95(70) HS81(56)  
W17½" D16¾" H37½(27%) SH32(22¼)"

p. 244-247



**EVERGREEN**

CB1140  
L44 P46 H95 HS65  
W17½" D18½" H37½" SH25½"

p. 254-255



**GARDA**

CB1688  
L44,5 P50,6 H98 HS65  
W17½" D20" H38¾" SH25½"

p. 262-263



**JAM**

CB1485  
L46,5 P46 H77,5 HS65  
W18½" D18½" H30¾" SH25½"

p. 286-293



**JAM**

CB1487  
L50 P50 H92,5 HS80  
W19¾" D19¾" H36½" SH31½"

p. 286-293



**JAM**

CB1033  
L48 P51 H77,5 HS65  
W19" D20½" H30¾" SH25½"

p. 286-293

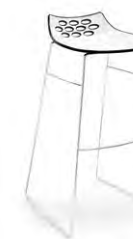

**JAM**

CB1034  
L48 P51 H92,5 HS80  
W19" D20½" H36½" SH31½"

p. 286-293



**GO!**

CB1513  
L43 P49 H94 HS65  
W17" D19¾" H37¾" SH25½"

p. 264-267



**GO!**

CB1689  
L43 P49 H94 HS65  
W17" D19¾" H37¾" SH25½"

p. 264-267



**ICE**

CB1049  
L41,5 P42,5 H82,5 HS65  
W16¾" D16¾" H32½" SH25½"

p. 278-281



**ICE**

CB1050  
L41,5 P42,5 H98 HS80  
W16¾" D16¾" H38¾" SH31½"

p. 278-281



**JAM**

CB1035  
L44 P43 H93(73,5) HS80(61)  
W17¾" D17" H36¾(29) SH31¼(24½)"

p. 286-293



**JAM**

CB1476  
L44 P43 H93(71) HS80(58)  
W17¾" D17" H36¾(28) SH31¼(22½)"

p. 286-293



**JELLY**

CB1529  
L43 P52 H95 HS65  
W17" D20½" H37½" SH25½"

p. 294-297



**JELLY METAL**

CB1969  
L43 P51 H94 HS65  
W17" D20½" H37¾" SH25½"

p. 298-301



**ICE**

CB1039  
L42,5 P44 H97,5(78,5) HS84(65)  
W16¾" D17¾" H38¾(31) SH33¼(25%)

p. 278-281



**ICE**

CB1475  
L41,5 P42,5 H98(76) HS80(58)  
W16¾" D16¾" H38¾(30) SH31¼(22¼)"

p. 278-281



**INDUSTRIAL**

CB1957  
L44 P44 H65  
W17¾" D17¾" H25½"

p. 282-285



**INDUSTRIAL**

CB1958  
L46 P46 H80  
W18½" D18½" H31½"

p. 282-285



**JENNY**

CB1219  
L44 P56 H94 HS65  
W17¾" D22¼" H37¾" SH25½"

p. 302-303



**JOE**

CB1532  
L40 P47 H103(81) HS81,5(59,5)  
W15¾" D18½" H40¾(32) SH32¼(23½)"

p. 304-304



**L'EAU**

CB1269  
L41,5 P42,5 H84,5 HS65  
W16¾" D16¾" H33¾" SH25½"

p. 306-309



**L'EAU**

CB1270  
L41,5 P43,5 H98,5 HS80  
W16¾" D17¼" H38¾" SH31½"

p. 306-309



**L'EAU**  
CB1288  
L42,5 P45 H99,5(80,5) HS84(65)  
W16¼" D17¼" H39¼(31¼)" SH33¼(25¼)"  
p. 306-309



**L'EAU**  
CB1477  
L42,5 P45 H98(76) HS80(58)  
W16¼" D17¼" H38¾(30)" SH31½(22¼)"  
p. 306-309



**LED**  
CB1541  
L44 P46 H78,5 HS65  
W17¾" D18¼" H31" SH25¼"  
p. 310-315



**LED**  
CB1427  
L41,5 P42,5 H83 HS67  
W16¾" D16¼" H32¼" SH26½"  
p. 310-315



**RILEY**  
CB2116  
L43 P48,5 H91 HS75  
W17" D19¼" H35¼" SH29¼"  
p. 90-97



**RILEY SOFT**  
CB2116-A  
L43 P48,5 H91 HS76  
W17" D19¼" H35¼" SH30"  
p. 90-97



**RILEY**  
CB2109  
L38 P46 H91,5(76,5) HS81(65)  
W15" P 18¼" H36¼(30¼)" SH32(25¼)"  
p. 90-97



**RILEY SOFT**  
CB2109-A  
L38 P46 H91,5(76,5) HS82(66)  
W15" D18¼" H36¼(30¼)" SH32¼(26)"  
p. 90-97



**LED**  
CB1428  
L41,5 P42,5 H98 HS82  
W16¾" D16¼" H38¾" SH32¾"  
p. 310-315



**LED**  
CB1405  
L41,5 P42,5 H98(76) HS80(58)  
W16¾" D16¼" H38¾(30)" SH31½(22¼)"  
p. 310-315



**NEWYORK**  
CB1087  
L57 P55 H91 HS65  
W22½" D21¼" H35¼" SH25¼"  
p. 322-329



**NEWYORK**  
CB1088  
L57 P53 H110(97) HS80(66)  
W22½" D20¼" H43¾(38¼)" SH31½(26)"  
p. 322-329



**ROCKET**  
CB1960  
L40 P40 H81(66) HS81(66)  
W15¼" D15¼" H32(26)" SH32(26)"  
p. 336-337



**SIREN**  
CB1542  
L51 P55 H98 HS65  
W20¼" D21¼" H38¾" SH25¼"  
p. 350-353



**STULLE**  
CB2100  
L43 P43 H50  
W17" D17" H19¼"  
p. 110-123



**STULLE**  
CB2101  
L45 P45 H68  
W17¼" D17¼" H26¼"  
p. 110-123



**RILEY**  
CB2108  
L41 P48,5 H80 HS65  
W16¼" D19¼" H31½" SH25¼"  
p. 90-97



**RILEY SOFT**  
CB2108-A  
L41 P48,5 H80 HS66  
W16¼" D19¼" H31½" SH26"  
p. 90-97



**RILEY**  
CB2110  
L43 P47,5 H80 HS65  
W17" D18¼" H31½" SH25¼"  
p. 90-97



**RILEY SOFT**  
CB2110-A  
L43 P47,5 H80 HS66  
W17" D18¼" H31½" SH26"  
p. 90-97



**STULLE**  
CB2102  
L46 P46 H79  
W18¼" D18¼" H31¼"  
p. 110-123



**TUKA**  
CB1997  
L55 P56 H88 HS65  
W21¼" D22¼" H34¼" SH25¼"  
p. 144-157



**TUKA**  
CB1998  
L55 P56 H98 HS76  
W21¼" D22¼" H38¾" SH30"  
p. 144-157



**TUKA**  
CB1995  
L55 P56 H88 HS65  
W21¼" D22¼" H34¼" SH25¼"  
p. 144-157





**TUKA**  
CB1996  
L55 P56 H98 HS76  
W21¼" D22¼" H38¾" SH30"  
p. 144-157



**YO!**  
CB1987  
L50 P54 H98 HS67  
W19¼" D21¼" H38¾" SH26½"  
p. 158-177



**YO!**  
CB1987-N  
L50 P54 H98 HS67  
W19¼" D21¼" H38¾" SH26½"  
p. 158-177



**YO!**  
CB1987-A  
L50 P54 H98 HS65  
W19¼" D21¼" H38¾" SH25½"  
p. 158-177

**sedie  
chairs**



**ACADEMY**  
CB1665  
L44,5 P51 H84 HS46  
W17¾" D20¼" H33¼" SH18½"  
p. 182-197



**ACADEMY**  
CB1663  
L49 P51 H84 HS46  
W19¾" D20¼" H33¼" SH18½"  
p. 182-197



**ACADEMY**  
CB1671  
L53,5 P52,5 H83 HS45  
W21¼" D20¼" H32¾" SH17¼"  
p. 182-197



**YO!**  
CB1992  
L51 P54 H109 HS78  
W20¾" D21¾" H43" SH30¾"  
p. 158-177



**YO!**  
CB1992-N  
L51 P54 H109 HS78  
W20¾" D21¾" H43" SH30¾"  
p. 158-177



**YO!**  
CB1992-A  
L51 P54 H109 HS76  
W20¾" D21¾" H43" SH30"  
p. 158-177



**ACADEMY**  
CB1671-E  
L53,5 P52,5 H83 HS45  
W21¾" D20¾" H32¾" SH17¾"  
p. 182-197



**ACADEMY**  
CB1696  
L54 P52 H83 HS46  
W21¾" D20½" H33¾" SH18½"  
p. 182-197



**ACADEMY**  
CB1696-N  
L54 P52 H83 HS46  
W21¾" D20½" H33¾" SH18½"  
p. 182-197



**ACADEMY**  
CB1697  
L54 P52 H83 HS46 HB70  
W21¾" D20½" H32¾" SH17¾" AH27½"  
p. 182-197



**ACADEMY**  
CB1697-N  
L54 P52 H83 HS46 HB70  
W21¾" D20½" H32¾" SH17¾" AH27½"  
p. 182-197



**ACADEMY**  
CB1664  
L44,5 P51 H84 HS46  
W17¾" D20¼" H33¼" SH18½"  
p. 182-197



**ACADEMY**  
CB1694 180 | CB1694 360  
L49 P50 H85 HS46  
W19¾" D19¾" H33½" SH18½"  
p. 182-197



**ACE**  
CB1320  
L42 P45 H84 HS47  
W16¾" D17¾" H33¼" SH18½"  
p. 198-201



**ACE**  
CB1693  
L42 P45 H84 HS47  
W16½" D17¼" H33¾" SH18½"  
p. 198-201



**AIR**  
CB93  
L53 P55 H84 HS44  
W20¼" D21¼" H33¾" SH17¾"  
p. 202-203



**AIR HIGH**  
CB1069  
L51 P60 H97,5 HS45  
W20¼" D23¾" H38½" SH17¼"  
p. 204-205



**ALCHEMIA**  
CB1056  
L49,5 P51 H79 HS45  
W19½" D20¼" H31¼" SH17¼"  
p. 206-211



**CLELIA**  
CB2120  
L50 P52 H77 HS47  
W19¼" D20½" H30¾" SH18½"  
p. 32-39



**CLELIA**  
CB2120-A  
L50 P52 H77 HS46  
W19¼" D20½" H30¾" SH18½"  
p. 32-39



**CLIP**  
CB1974  
L43 P45 H79 HS46  
W17" D17¼" H31¾" SH18½"  
p. 234-237



**CLIP**  
CB1971  
L43 P45 H79 HS46  
W17" D17¼" H31¾" SH18½"  
p. 234-237



**AREA51**  
CB1042  
L50,5 P50 H80 HS45  
W20" D19¾" H31½" SH17¾"  
p. 212-215



**ARGO**  
CB1523  
L48 P47 H82 HS46  
W19" D18½" H32¾" SH18½"  
p. 216-221



**AURORA**  
CB1963  
L47 P56 H88 HS47  
W18½" D22¼" H34¾" SH18½"  
p. 222-223



**AURORA**  
CB1963-S  
L47 P56 H88 HS47  
W18½" D22¼" H34¾" SH18½"  
p. 222-223



**CLUB**  
CB1462  
L47 P57 H91 HS46  
W18½" D22½" H35¾" SH18½"  
p. 238-239



**COPENHAGEN**  
CB1656  
L47 P55 H96 HS45  
W18½" D21¼" H37¾" SH17¾"  
p. 240-243



**COPENHAGEN**  
CB1656-S  
L47 P55 H96 HS45  
W18½" D21¼" H37¾" SH17¾"  
p. 240-243



**EMMA**  
CB1662  
L48,5 P57 H85,5 HS47  
W19¾" D22½" H33¾" SH18½"  
p. 248-249



**BAYO**  
CB1983  
L52 P54 H82,5 HS46  
W20½" D21¾" H32½" SH18½"  
p. 18-27



**BAYO**  
CB2119  
L60 P54 H82,5 HS46 HB65  
W23¾" D21¾" H32½" SH18½" AH25%"  
p. 18-27



**BOHEME**  
CB1257  
L48 P52 H90 HS46,5  
W19" D20½" H35½" SH17¾"  
p. 224-227



**CAFFÈ**  
CB1970  
L43 P53 H83 HS47  
W17" D20¼" H32¾" SH18½"  
p. 228-233



**ESCUDO**  
CB1526  
L45 P53 H85 HS46  
W17¾" D20¾" H33½" SH18½"  
p. 250-253



**EVERGREEN**  
CB1139  
L44 P51 H82 HS47  
W17¾" D20¾" H32¾" SH18½"  
p. 254-255



**GAMERA**  
CB1459  
L53 P53 H82 HS45  
W20¾" D20¾" H32¾" SH17¾"  
p. 256-261



**GARDA**  
CB1525  
L44 P54 H96 HS46  
W17¾" D21¾" H37¾" SH18½"  
p. 262-263



**GO!**  
CB1419  
L42 P47 H83 HS46  
W16½" D18½" H32¾" SH18½"  
p. 264-267



**GO!**  
CB1690  
L42 P47 H83 HS46  
W16½" D18½" H32¾" SH18½"  
p. 264-267



**GOSSIP**  
CB1110  
L57 P61 H79,5 HS45 HB65  
W22½" D24½" H31¾" SH17¾" AH25½"  
p. 268-269



**HELIOS**  
CB1312  
L44 P52,5 H83 HS46  
W17¾" D20¾" H32¾" SH18½"  
p. 270-273



**JAM**  
CB1030  
L51,5 P54 H82,5 HS45  
W20¾" D21¾" H32½" SH17¾"  
p. 286-293



**JAM**  
CB1059  
L47,5 P54 H82,5 HS45  
W18¾" D21¾" H32½" SH17¾"  
p. 286-293



**JELLY**  
CB1528  
L42 P51,5 H80 HS45  
W16¾" D20¾" H31½" SH17¾"  
p. 294-297



**JELLY METAL**  
CB1954  
L42 P50 H80 HS46  
W16¾" D20¾" H31½" SH18½"  
p. 298-301



**HEXA**  
CB1936  
L51 P59 H89 HS47  
W20¾" D23¾" H35½" SH18½"  
p. 274-277



**HEXA**  
CB1937  
L51 P59 H89 HS47  
W20¾" D23¾" H35½" SH18½"  
p. 274-277



**HEXA**  
CB1977  
L51 P59 H89 HS47  
W20¾" D23¾" H35½" SH18½"  
p. 274-277



**HEXA**  
CB1938  
L51 P59 H89 HS47  
W20¾" D23¾" H35½" SH18½"  
p. 274-277



**JENNY**  
CB1362  
L42 P54 H86 HS45  
W16¾" D21¾" H33¾" SH17¾"  
p. 302-303



**L'EAU**  
CB1273  
L55 P55 H80 HS45  
W21¾" D21¾" H31½" SH17¾"  
p. 306-309



**L'EAU**  
CB1273-N  
L47,5 P55 H80 HS45  
W18¾" D21¾" H31½" SH17¾"  
p. 306-309



**LED**  
CB1507  
L49 P54 H81 HS45  
W19¾" D21¾" H32" SH17¾"  
p. 310-315



**HEXA**  
CB1935  
L50 P58 H90 HS47  
W19¾" D22¾" H35½" SH18½"  
p. 274-277



**HEXA**  
CB1934  
L49 P59 H89 HS47  
W19¾" D23¾" H35½" SH18½"  
p. 274-277



**ICE**  
CB1038  
L47,5 P53,5 H82 HS46  
W18¾" D21¾" H32¾" SH18½"  
p. 278-281



**JAM**  
CB1486  
L47,5 P54 H82,5 HS45  
W18¾" D21¾" H32½" SH17¾"  
p. 286-293



**LED**  
CB1298  
L51 P53 H80 HS45  
W20¾" D20¾" H31½" SH17¾"  
p. 310-315



**LED**  
CB1298-N  
L47 P53 H80 HS45  
W18¾" D20¾" H31½" SH17¾"  
p. 310-315



**MAYA**  
CB1914  
L51 P61 H92 HS47  
W20¾" D24¾" H36¼" SH18½"  
p. 316-319



**MAYA**  
CB1926  
L51 P61 H92 HS47  
W20¾" D24¾" H36¼" SH18½"  
p. 316-319



**MAYA**  
CB1919  
L51 P61 H92 HS47  
W20¼" D24¼" H36¼" SH18½"  
p. 316-319



**MAYA**  
CB1976  
L51 P61 H92 HS47  
W20¼" D24¼" H36¼" SH18½"  
p. 316-319



**MAYA**  
CB1927  
L51 P61 H92 HS47  
W20¼" D24¼" H36¼" SH18½"  
p. 316-319



**MAYA**  
CB1913  
L51 P61 H92 HS47  
W20¼" D24¼" H36¼" SH18½"  
p. 316-319



**ROSIE SOFT**  
CB1922  
L55 P59 H79 HS47 HB67  
W21¼" D23¼" H31¼" SH18½" AH26½"  
p. 338-341



**ROSIE SOFT**  
CB1923  
L55 P59 H79 HS47 HB67  
W21¼" D23¼" H31¼" SH18½" AH26½"  
p. 338-341



**ROSIE SOFT**  
CB1901  
L55 P59 H79 HS47 HB67  
W21¼" D23¼" H31¼" SH18½" AH26½"  
p. 338-341



**ROSIE SOFT**  
CB1924  
L55 P59 H79 HS47 HB67  
W21¼" D23¼" H31¼" SH18½" AH26½"  
p. 338-341



**MAYA**  
CB1925  
L51 P60 H93 HS47  
W20¼" D23¼" H36¼" SH18½"  
p. 316-319



**MILANO**  
CB1284  
L43 P47 H81 HS45  
W17" D18½" H32" SH17¼"  
p. 320-321



**NEW YORK**  
CB1022  
L57 P52 H75,5 HS45 HB64  
W22½" D20¼" H29¼" SH17¼" AH25¼"  
p. 322-329



**NOVA**  
CB1669  
L42 P47 H83,5 HS46  
W16½" D18¼" H32¼" SH18½"  
p. 330-331



**ROSIE SOFT**  
CB1921  
L55 P59 H78 HS47 HB67  
W21¼" D23¼" H30¼" SH18½" AH26½"  
p. 338-341



**SAMI**  
CB1472  
L48 P53 H83,5 HS45  
W19" D20¼" H32¼" SH17¼"  
p. 342-343



**SANDY**  
CB1260  
L48,5 P55,5 H96,5 HS45  
W19¼" D21¼" H38" SH17¼"  
p. 344-345



**SIBILLA**  
CB1959  
L45 P56 H83 HS47  
W17¼" D22¼" H32¼" SH18½"  
p. 346-349



**NOVA**  
CB1666  
L41,5 P47 H83,5 HS46  
W16½" D18¼" H32¼" SH18½"  
p. 330-331



**ROBINSON**  
CB1436  
L43,5 P52,5 H82 HS47  
W17¼" D20¼" H32¼" SH18½"  
p. 332-333



**ROBINSON SOFT**  
CB1436-S  
L45 P52,5 H82 HS47  
W17¼" D20¼" H32¼" SH18½"  
p. 334-335



**ROSIE SOFT**  
CB1910  
L55 P59 H79 HS47 HB67  
W21¼" D23¼" H31¼" SH18½" AH26½"  
p. 338-341



**SIBILLA SOFT**  
CB1959-A  
L45 P56 H83 HS49,5  
W17¼" D22¼" H32¼" SH19½"  
p. 98-103



**SIGNORINA**  
CB2111  
L56 P53 H77 HS47 HB62  
W22¼" D20¼" H30¼" SH18½" AH24¼"  
p. 104-109



**SIREN**  
CB1536  
L52 P56 H77 HS47  
W20¼" D22¼" H30¼" SH18½"  
p. 350-353



**SNACK**  
CB1956  
L46 P53 H79 HS46  
W18¼" D20¼" H31¼" SH18½"  
p. 354-357



**SONORA**  
CB1973  
L49 P55 H82 HS47  
W19½" D21¼" H32¾" SH18½"  
p. 358-359



**TUKA**  
CB1994  
L46 P57 H81 HS47  
W18½" D22½" H32" SH18½"  
p. 144-157



**TUKA**  
CB2117  
L55 P56 H76 HS47 HB65  
W21¼" D22½" H30" SH18½" AH25½"  
p. 144-157



**TUKA**  
CB1993  
L46 P57 H81 HS47  
W18½" D22½" H32" SH18½"  
p. 144-157



**TUKA**  
CB1999  
L55 P56 H76 HS47 HB65  
W21¼" D22½" H30" SH18½" AH25½"  
p. 144-157



**UP!**  
CB1955  
L49 P48 H81 HS47  
W19½" D19" H32" SH18½"  
p. 360-363



**YO!**  
CB1986  
L47 P55,5 H81 HS47  
W18½" D21¼" H32" SH18½"  
p. 158-177



**YO!**  
CB1986-N  
L47 P55,5 H81 HS47  
W18½" D21¼" H32" SH18½"  
p. 158-177



**YO!**  
CB1986-A  
L47 P55,5 H81 HS45  
W18½" D21¼" H32" SH17¾"  
p. 158-177



**YO!**  
CB1988  
L47 P55,5 H81 HS47  
W18½" D21¼" H32" SH18½"  
p. 158-177



**YO!**  
CB1988-N  
L47 P55,5 H81 HS47  
W18½" D21¼" H32" SH18½"  
p. 158-177



**YO!**  
CB1988-A  
L47 P55,5 H81 HS45  
W18½" D21¼" H32" SH17¾"  
p. 158-177

**sedie  
home office  
home office  
chairs**



**ACADEMY**  
CB1911  
L63 P63 H92(83,5) HS55(46)  
W24¾" D24¾" H36¼(32¾)" SH21¼(18¼)"  
p. 182-197



**ACADEMY**  
CB1695  
L61 P57 H92(81) HS54(43)  
W24¼" D22½" H36¼(32)" SH21¼(17)"  
p. 182-197



**AIR RACE**  
CB321  
L60 P64 H92(83) HS53(44) HB 75(66)  
W23¾" D25¼" H36¼(32¾)" SH20¾(17¾)"  
AH29¾(25)"  
p. 202-203



**JAM**  
CB623  
L63 P62 H90(81) HS53(44)  
W24¾" D24½" H35½(32)" SH20¾(17¾)"  
p. 286-293



**NEW YORK**  
CB624  
L63 P65 H87(78) HS54(45) HB 64(55)  
W24¾" D25¾" H34¼(30¾)" SH21¼(17¾)"  
AH 25¼(21¼)"  
p. 322-329

**sedie  
pieghevoli  
folding  
chairs**



**ALU**  
CB205  
L45 P55(4,5) H85(96) HS45  
W17¼" D21¼(1¼)" H33¼(37¾)" SH17¼"  
p. 364-365



**OLIVIA**  
CB208  
L38,5 P48(4) H80(96) HS46  
W15¼" D19(1¼)" H31¼(37¾)" SH18½"  
p. 366-367



**SKIP**  
CB207  
L47 P51(5) H80(91) HS46  
W18½" D20¼(2)" H31¼(35¾)" SH18½"  
p. 368-369

**sedie lounge,  
panche e pouf**  
*lounge chairs,  
benches and  
ottomans*



**POF**  
CB5207  
L47 P47 H48  
W18½" D18½" H19"  
p. 80-85



**STULLE**  
CB5208  
L82,5 P42,5 H47  
W32½" D16¼" H18½"  
p. 110-123



**TUKA**  
CB2113  
L69 P67 H80 HS37  
W27¼" D26½" H31½" SH14⅝"  
p. 144-157



**TUKA**  
CB2114  
L69 P67 H80 HS37  
W27¼" D26½" H31½" SH14⅝"  
p. 144-157



**YO!**  
CB5210  
L130 P41 H48  
W51¼" D16¼" H19"  
p. 158-177

**tavoli fissi e  
allungabili**  
*extending and  
non-extending  
tables*



**AIRPORT**  
CB4011-R  
p. 372-377



**ALADINO**  
CB4742-Q  
p. 378-381



**ALADINO**  
CB4742-R  
p. 378-381



**ATHOS**  
CB4783-R  
p. 382-387



**BARON**  
CB4010-FR  
p. 388-397



**BARON**  
CB4010-R  
p. 388-397



**BARON COUNTER**  
CB4010-FRH  
p. 398-399



**DINE**  
CB4094-R  
p. 408-413



**DIX**  
CB4804-FD  
p. 46-51



**BARON COUNTER**  
CB4010-RH  
p. 398-399



**BOLD**  
CB4795-R 160  
p. 400-405



**EMINENCE Metal**  
CB4724-R  
p. 414-421



**EMINENCE Wood**  
CB4724-R  
p. 422-427



**COCKTAIL**  
CB4759-FD  
p. 406-407



**DINE**  
CB4094-Q  
p. 408-413



**EMINENCE FAST**  
CB4788-R  
p. 428-433



**EXCELLENCE**  
CB4784-R  
p. 434-437



**GATE**  
CB4088-R  
p. 438-443



**GIOVE**  
CB4739-D  
p. 444-451



**MIKADO**  
CB4789-R  
p. 456-459



**PEGASO**  
CB4799-R  
p. 460-465



**GIOVE**  
CB4739-E  
p. 444-451



**IRON**  
CB4809-FR  
p. 58-63



**PENTAGON**  
CB4797-R  
p. 466-473



**PENTAGON FAST**  
CB4800-R  
p. 474-481



**MIKADO FIX**  
CB4728-FD  
p. 452-455



**MIKADO FIX**  
CB4728-FR  
p. 452-455



**PLANET**  
CB4005-FD  
p. 482-485



**ROYAL**  
CB4082-MV  
p. 486-487





**SIGMA**  
CB4069  
p. 488-493



**SINCRO**  
CB4087  
p. 494-497



**TRIA**  
CB4807-FD  
p. 134-143



**TRIA**  
CB4807-FR  
p. 134-143



**SNAP**  
CB4085-R  
p. 498-503



**STECCO**  
CB4793-FD  
p. 504-505



**WINGS**  
CB4801-R | CB4796-R  
p. 506-511



**YO!**  
CB4805-FD  
p. 158-177



**STULLE TABLE**  
CB4806-FD  
p. 110-123



**TABLA**  
CB4803-R  
p. 124-129



**YO!**  
CB4805-FR  
p. 158-177



**ZEFFIRO**  
CB4798-R  
p. 512-517



**TAVOLI CONTRACT | CONTRACT TABLE**  
BRANCH/COCKTAIL/STECCHO

p. 518-529



**MAGIC-J**

CB5041-G  
L115(150) P75 H72(34)(64)  
W45½(59½)" D29½" H28½(13½)(25¼)"

p. 536-539



**MASCOTTE**

CB490  
L105 P70(140) H74(32,5)(64,5)  
W41½" D27½(55½)" H29¼(12¼)(25½)"

p. 540-543

**tavoli e consolle pieghevoli,  
tavolini trasformabili**  
*folding tables and consoles,  
multi-purpose tables*



**DEE-J**

CB4808-RC 40  
L120P40(80) H77(73)  
W47¼" D15¼" H30½(28¼)"

p. 40-45



**QUADRO**

CB08  
L90 P14(60) H50  
W35½" D23½(5½)" H19¼"

p. 86-89



**QUADRO**

CB08-A  
L90 P14,5(60) H62  
W35½" D23½(5½)" H24½"

p. 86-89



**EMINENCE CONSOLLE**

CB4724-RC 50  
L50(100)(150)(200)(250)(300) P90 H76(66,5)  
W19½(39½)(59½)(78½)(98½)(118½)" D35½" H30"

p. 530-531



**MAGIC-J**

CB5041-W  
L110 P75(150) H74(34)(64)  
W43¾" D29½(59½)" H29¼(13½)(25¼)"

p. 536-539



**SIGMA CONSOLLE**

CB4069-RCX 49  
L49(99,5)(150)(200)(250)(300) P100 H75(65)  
W19¾(39¼)(59½)(78½)(98½)(118½)" D39¾" H29¾"

p. 532-533



**SPAZIO**

CB07  
L20(73)(126) P80 H72,5  
W7½(28¼)(49½)" D31½" H28¾"

p. 534-535

**complementi  
occasionals**



**APP**  
CB5212  
Ø45 H166  
Ø17¼" H65¾"  
p. 10-13



**BAIK**  
CB5211  
L26,5 P29 H30  
W10½" D11½" H11¼"  
p. 14-17



**BIBLI**  
CB5201  
L70 P15,5 H15  
W27¼" D6¼" H6"  
p. 28-31



**ISLANDS**  
CB5061-A  
L40 P40 H42  
W15¼" D15¼" H16¾"  
p. 544-545



**ISLANDS**  
CB5061-B  
L40 P40 H55  
W15¼" D15¼" H21¼"  
p. 544-545



**LUNE**  
CB5074  
L90 P2,5  
W35½" D1"  
p. 550-551



**MIRÒ**  
CB5213-P  
L70 P2 H79,5  
W27¼" D0¼" H31¾"  
p. 76-79



**BUBBLES**  
CB5029  
L98 P2,5 H51,5  
W38¾" D1" H20¾"  
p. 546-547



**DROP**  
CB5034-P  
L65 P2,5 H87  
W25¾" D1" H34¼"  
p. 548-549



**DROP**  
CB5034-G  
L60 P2,5 H154  
W23¾" D1" H60¾"  
p. 548-549



**ENS**  
CB5202  
L60 P2 H8  
W23¾" D0¾" H3¼"  
p. 52-57



**MIRÒ**  
CB5213-G  
L64 P2 H106,5  
W25¼" D0¾" H42"  
p. 76-79



**STULLE**  
CB5209-P  
Ø40 H40  
Ø15¾" H15¾"  
p. 110-123



**STULLE**  
CB5209-G  
Ø70 H30  
Ø27¾" H11¾"  
p. 110-123



**TAPÌ**  
CB7224-A  
L160 P240 H1,3  
W63" D94½" H0¾"  
p. 130-133



**ENS**  
CB5206  
L36,5 P15 H8  
W14¾" D6" H3¼"  
p. 52-57



**ENS**  
CB5203  
L17 P19 H16  
W6¾" D7½" H6¾"  
p. 52-57



**ENS**  
CB5204  
L17 P13 H8  
W6¾" D5¼" H3¼"  
p. 52-57



**ENS**  
CB5205  
L17 P13 H16  
W6¾" D5¼" H6¾"  
p. 52-57



**TAPÌ**  
CB7224-B  
L200 P300 H1,3  
W78¾" D118¼" H0¾"  
p. 130-133

**mobili**  
*cabinets*



**LIBRA**  
CB6102-1  
L90 P38,5 H110,4  
W35½" D15¼" H43½"

p. 64-69



**LIBRA**  
CB6102-2  
L162 P38,5 H110,4  
W63¾" D15¼" H43½"

p. 64-69



**LIBRA**  
CB6102-3  
L90 P38,5 H184,4  
W35½" D15¼" H72¾"

p. 64-69



**LIBRA**  
CB6102-4  
L162 P38,5 H184,4  
W63¾" D15¼" H72¾"

p. 64-69



**MADE**  
CB6101-1  
L108 P40 H75,5  
W42¾" D15¼" H29¾"

p. 70-75



**MADE**  
CB6101-2  
L144 P40 H75,5  
W56¾" D15¼" H29¾"

p. 70-75



**MADE**  
CB6101-3  
L162 P40 H75,5  
W63¾" D15¼" H29¾"

p. 70-75



**MADE**  
CB6101-4  
L162 P40 H75,5  
W63¾" D15¼" H29¾"

p. 70-75



**MADE**  
CB6101-5  
L162 P40 H39,5  
W63¾" D15¼" H15¾"

p. 70-75



**MADE**  
CB6101-6  
L162 P40 H57,5  
W63¾" D15¼" H22¾"

p. 70-75

NOME/NAME	CODICE/CODE	CM	INCHES
Airport	CB4011-R 130	L130(195)(260) P90 H76,5(64,5)	W51¼(76¾)(102¾) D35½" H30¼(25½)"
Aladino	CB4742-Q 80	L80(160) P80 H75(69)	W31½(62)" D31½" H29¾(27¼)"
Aladino	CB4742-R 110	L110(150) P70 H75(69)	W43¾(59¼)" D27¾" H29¾(27¼)"
Aladino	CB4742-R 120	L120(180) P85 H75(69)	W47¼(70¾)" D33½" H29¾(27¼)"
Athos	CB4783-R 150	L150(200) P100 H75(66)	W59¾(78¼)" D39¾" H29¾(25)"
Athos	CB4783-R 180	L180(230) P100 H75(66)	W70¾(90¾)" D39¾" H29¾(25)"
Baron	CB4010-FR 110	L110 P70 H75(67)	W43¾" D27¾" H29¾(26½)"
Baron	CB4010-R 110	L110(155) P70 H75(67)	W43¾(61¼)" D27¾" H29¾(26½)"
Baron	CB4010-FR 130	L130 P85 H75(67)	W51¼" D33½" H29¾(26½)"
Baron Counter	CB4010-FRH 130	L130 P85 H90(82)	W51¼" D33½" H35¼(32¾)"
Baron	CB4010-R 130	L130(190) P85 H75(67)	W51¼(74¾)" D33½" H29¾(26½)"
Baron Counter	CB4010-RH 130	L130(190) P85 H90(82)	W51¼(74¾)" D33½" H35¼(32¾)"
Baron	CB4010-FR 160	L160 P85 H75(67)	W62" D33½" H29¾(26½)"
Baron	CB4010-R 160	L160(220) P85 H75(67)	W62(86¾)" D33½" H29¾(26½)"
Baron	CB4010-FR 180	L180 P100 H75(67)	W70¾" D39¾" H29¾(26½)"
Baron	CB4010-R 180	L180(240) P100 H75(67)	W70¾(94¼)" D39¾" H29¾(26½)"
Bold	CB4795-R 160	L160(210)(260)(310) P90 H76(69)	W62(82¼)(102¾)(122¾)" D35½" H29(27¼)"
Cocktail	CB4759-FD 90	Ø90 H76(73)	Ø35½" H30(28¾)"
Cocktail	CB4759-FD 120	Ø120 H76(73)	Ø47¼" H30(28¾)"
Dine	CB4094-Q 90	L90(130) P90 H75(65,5)	W35½(51¼)" D35½" H29¾(25¾)"
Dine	CB4094-R 110	L110(150) P70 H75(65,5)	W43¾(59¼)" D27¾" H29¾(25¾)"
Dine	CB4094-R 120	L120(170) P80 H75(65,5)	W47¼(66)" D31½" H29¾(25¾)"
Dix	CB4804-FD 90	Ø90 H76(73)	Ø35½" H30(28¾)"
Dix	CB4804-FD 120	Ø120 H76(73)	Ø47¼" H30(28¾)"
Eminence	CB4724-R 110 A	L110(155) P70 H76(66,5)	W43¾(61¼)" D27¾" H29(26¼)"
Eminence	CB4724-R 130 A	L130(180) P90 H76(66,5)	W51¼(70¾)" D35½" H29(26¼)"
Eminence	CB4724-R 130 B	L130(180)(230) P90 H76(66,5)	W51¼(70¾)(90¾)" D35½" H29(26¼)"
Eminence	CB4724-R 160 A	L160(210) P90 H76(66,5)	W62(82¼)" D35½" H29(26¼)"
Eminence	CB4724-R 160 B	L160(210)(260) P90 H76(66,5)	W62(82¼)(102¾)" D35½" H29(26¼)"
Eminence	CB4724-R 160 C	L160(210)(260)(310) P90 H76(66,5)	W62(82¼)(102¾)(122¾)" D35½" H29(26¼)"
Eminence Fast	CB4788-R 130	L130(230) P90 H76(66,5)	W51¼(90¾)" D35½" H29(26¼)"
Eminence Fast	CB4788-R 160	L160(260) P90 H76(66,5)	W62(102¾)" D35½" H29(26¼)"
Excellence	CB4784-R 120	L120(200) P80 H76(68)	W47¼(78¼)" D31½" H29(26¾)"
Gate	CB4088-R 160	L160(220) P90 H75(65)	W62(86¾)" D35½" H29¾(25¾)"
Gate	CB4088-R 180	L180(240) P100 H75(65)	W70¾(94¼)" D39¾" H29¾(25¾)"
Giove	CB4739-D 120	L120(165) P120 H75(61)	W47¼(64)" D47¼" H29¾(24¾)"
Giove	CB4739-E 140	L140(190) P100 H75(61)	W55¾(74¾)" D39¾" H29¾(24¾)"
Iron	CB4809-FR 160	L160 P90 H75(72)	W63" D35½" H29¾(28¾)"
Iron	CB4809-FR 200	L200 P100 H75(72)	W78¾" D39¾" H29¾(28¾)"
Mikado	CB4728-FD 120	Ø120 H76(75)	Ø47¼" H29(29¾)"
Mikado	CB4728-FD 140	Ø140 H76(75)	Ø55½" H29(29¾)"
Mikado	CB4728-FR 130	L130 P85 H76(75)	W51¼" D33½" H29(29¾)"
Mikado	CB4789-R 130	L130(180) P90 H76(69)	W51¼(70¾)" D35½" H29(27¼)"
Mikado	CB4728-FR 160	L160 P90 H76(75)	W62" D35½" H29(29¾)"
Mikado	CB4789-R 160	L160(210) P90 H76(69)	W62(82¼)" D35½" H29(27¼)"
Mikado	CB4728-FR 180	L180 P90 H76(75)	W70¾" D35½" H29(29¾)"
Pegaso	CB4799-R 150	L150(190)(230) P90 H76(64)	W59¾(74¾)(90¾)" D35½" H29(25¼)"
Pentagon	CB4797-R 130 A	L130(180) P90 H76(68)	W51¼(70¾)" D35½" H29(26¾)"
Pentagon	CB4797-R 130 B	L130(180)(230) P90 H76(68)	W51¼(70¾)(90¾)" D35½" H29(26¾)"
Pentagon	CB4797-R 160 A	L160(210) P90 H76(68)	W62(82¼)" D35½" H29(26¾)"
Pentagon	CB4797-R 160 B	L160(210)(260) P90 H76(68)	W62(82¼)(102¾)" D35½" H29(26¾)"
Pentagon	CB4797-R 160 C	L160(210)(260)(310) P90 H76(68)	W62(82¼)(102¾)(122¾)" D35½" H29(26¾)"
Pentagon Fast	CB4800-R 130	L130(230) P90 H76(68)	W51¼(90¾)" D35½" H29(26¾)"
Pentagon Fast	CB4800-R 160	L160(260) P90 H76(68)	W62(102¾)" D35½" H29(26¾)"
Planet	CB4005-FD 90	Ø90 H75(73,5)	Ø35½" H29¾(29)"
Planet	CB4005-FD 120	Ø120 H75(73,5)	Ø47¼" H29¾(29)"
Royal	CB4082-MV 180	L180(240) P100 H75(65)	W70¾(94¼)" D39¾" H29¾(25¾)"
Sigma	CB4069-R 160	L160(220) P90 H75(65)	W62(86¾)" D35½" H29¾(25¾)"
Sigma	CB4069-R 180	L180(240) P100 H75(65)	W70¾(94¼)" D39¾" H29¾(25¾)"
Sigma XL	CB4069-RX 180	L180(240)(300) P100 H75(65)	W70¾(94¼)(118¾)" D39¾" H29¾(25¾)"
Sincro	CB4087	L180(280) P100 H76(67)	W70¾(110¼)" D39¾" H29(26¼)"
Snap	CB4085-R 110	L110(160) P70 H76(67,5)	W43¾(62)" D27¾" H29(26¾)"
Snap	CB4085-R 120	L120(180) P80 H76(67,5)	W47¼(70¾)" D31½" H29(26¾)"
Snap	CB4085-R 130	L130(190) P90 H76(67,5)	W51¼(74¾)" D35½" H29(26¾)"
Stecco	CB4793-FD 90	Ø90 H76(73)	Ø35½" H30(28¾)"
Stecco	CB4793-FD 120	Ø120 H76(73)	Ø47¼" H30(28¾)"
Stulle Table	CB4806-FD 120	Ø120 H75(60,5)	Ø47¼" H29¾(23¾)"
Tabla	CB4803-R 130	L132(182) P92 H76(68)	W52(71¼)" D36¼" H30(26¾)"
Tabla	CB4803-R 160	L162(212) P92 H76(68)	W63¾(83½)" D36¼" H30(26¾)"
Tria	CB4807-FD 120	Ø120 H76(73,5)	Ø47¼" H30(29)"
Tria	CB4807-FR 160	L160 P90 H76(73,5)	W63" D35½" H30(29)"
Tria	CB4807-FR 200	L200 P100 H76(73,5)	W78¾" D39¾" H30(29)"
Wings	CB4801-R 150	L150(190)(230) P90 H76(64)	W59¾(74¾)(90¾)" D35½" H29(25¼)"
Wings	CB4796-R 160	L160(210)(260)(310) P90 H76(69)	W62(82¼)(102¾)(122¾)" D35½" H29(27¼)"
Yo!	CB4805-FD 120	Ø120 H76(73,5)	Ø47¼" H30(29)"
Yo!	CB4805-FR 160	L160 P90 H76(73,5)	W63" D35½" H30(29)"
Yo!	CB4805-FR 200	L200 P100 H76(73,5)	W78¾" D39¾" H30(29)"
Zeffiro	CB4798-R 140	L140(180)(220) P90 H76(63)	W55¾(70¾)(86¾)" D35½" H30(24¾)"
Zeffiro	CB4798-R 160	L160(200)(240) P90 H76(63)	W62(78¾)(94¼)" D35½" H30(24¾)"

## sgabelli stools

CB57	Air	202-203
CB1033	Jam	286-293
CB1034	Jam	286-293
CB1035	Jam	286-293
CB1039	Ice	278-281
CB1049	Ice	278-281
CB1050	Ice	278-281
CB1087	New York	322-329
CB1088	New York	322-329
CB1140	Evergreen	254-255
CB1219	Jenny	302-303
CB1269	L'eau	306-309
CB1270	L'eau	306-309
CB1288	L'eau	306-309
CB1329	Ace	198-201
CB1393	Boheme	224-227
CB1405	Led	310-315
CB1427	Led	310-315
CB1428	Led	310-315
CB1475	Ice	278-281
CB1476	Jam	286-293
CB1477	L'eau	306-309
CB1485	Jam	286-293
CB1487	Jam	286-293
CB1513	Go!	264-267
CB1529	Jelly	294-297
CB1532	Joe	304-304
CB1541	Led	310-315
CB1542	Siren	350-353
CB1672	Academy	182-197
CB1673	Academy	182-197
CB1674	Academy	182-197
CB1675	Academy	182-197
CB1676	Academy	182-197
CB1688	Garda	262-263
CB1689	Go!	264-267
CB1692	Ace	198-201
CB1939	Cosmopolitan	244-247
CB1940	Cosmopolitan	244-247
CB1941	Cosmopolitan	244-247
CB1942	Cosmopolitan	244-247
CB1943	Cosmopolitan	244-247
CB1944	Cosmopolitan	244-247
CB1957	Industrial	282-285
CB1958	Industrial	282-285
CB1960	Rocket	336-337
CB1969	Jelly Metal	298-301
CB1972	Clip	234-237
CB1975	Clip	234-237
CB1984	Bayo	18-27

CB1985	Bayo	18-27
CB1987	Yo!	158-177
CB1987-A	Yo!	158-177
CB1987-N	Yo!	158-177
CB1992	Yo!	158-177
CB1992-A	Yo!	158-177
CB1992-N	Yo!	158-177
CB1995	Tuka	144-157
CB1996	Tuka	144-157
CB1997	Tuka	144-157
CB1998	Tuka	144-157
CB2100	Stulle	110-123
CB2101	Stulle	110-123
CB2102	Stulle	110-123
CB2108	Riley	90-97
CB2108-A	Riley Soft	90-97
CB2109	Riley	90-97
CB2109-A	Riley Soft	90-97
CB2110	Riley	90-97
CB2110-A	Riley Soft	90-97
CB2116	Riley	90-97
CB2116-A	Riley Soft	90-97
CB2121	Clelia	32-39
CB2121-A	Clelia	32-39
CB2122	Clelia	32-39
CB2122-A	Clelia	32-39
CB2123	Clelia	32-39
CB2124	Clelia	32-39

## sedie chairs

CB93	Air	202-203
CB1022	New York	322-329
CB1030	Jam	286-293
CB1038	Ice	278-281
CB1042	Area51	212-215
CB1056	Alchemia	206-211
CB1059	Jam	286-293
CB1069	Air High	204-205
CB1110	Gossip	268-269
CB1139	Evergreen	254-255
CB1257	Boheme	224-227
CB1260	Sandy	344-345
CB1273	L'eau	306-309
CB1273-N	L'eau	306-309
CB1284	Milano	320-321
CB1298	Led	310-315
CB1298-N	Led	310-315
CB1312	Helios	270-273
CB1320	Ace	198-201
CB1362	Jenny	302-303

CB1419	Go!	264-267
CB1436	Robinson	332-333
CB1436-S	Robinson Soft	334-335
CB1459	Gamera	256-261
CB1462	Club	238-239
CB1472	Sami	342-343
CB1486	Jam	286-293
CB1507	Led	310-315
CB1523	Argo	216-221
CB1525	Garda	262-263
CB1526	Escudo	250-253
CB1528	Jelly	294-297
CB1536	Siren	350-353
CB1656	Copenhagen	240-243
CB1656-S	Copenhagen	240-243
CB1662	Emma	248-249
CB1663	Academy	182-197
CB1664	Academy	182-197
CB1665	Academy	182-197
CB1666	Nova	330-331
CB1669	Nova	330-331
CB1671	Academy	182-197
CB1671-E	Academy	182-197
CB1677	Academy	182-197
CB1678-1	Academy	182-197
CB1690	Go!	264-267
CB1693	Ace	198-201
CB1694 180	Academy	182-197
CB1694 360	Academy	182-197
CB1696	Academy	182-197
CB1696-N	Academy	182-197
CB1697	Academy	182-197
CB1697-N	Academy	182-197
CB1901	Rosie Soft	338-341
CB1910	Rosie Soft	338-341
CB1913	Maya	316-319
CB1914	Maya	316-319
CB1919	Maya	316-319
CB1921	Rosie Soft	338-341
CB1922	Rosie Soft	338-341
CB1923	Rosie Soft	338-341
CB1924	Rosie Soft	338-341
CB1925	Maya	316-319
CB1926	Maya	316-319
CB1927	Maya	316-319
CB1934	Hexa	274-277
CB1935	Hexa	274-277
CB1936	Hexa	274-277
CB1937	Hexa	274-277
CB1938	Hexa	274-277
CB1954	Jelly Metal	298-301
CB1955	Up!	360-363
CB1956	Snack	354-357
CB1959	Sibilla	346-349
CB1959-A	Sibilla Soft	98-103

CB1963	Aurora	222-223
CB1963-S	Aurora	222-223
CB1966	Academy	182-197
CB1970	Caffè	228-233
CB1971	Clip	234-237
CB1973	Sonora	358-359
CB1974	Clip	234-237
CB1976	Maya	316-319
CB1977	Hexa	274-277
CB1983	Bayo	18-27
CB1986	Yo!	158-177
CB1986-A	Yo!	158-177
CB1986-N	Yo!	158-177
CB1988	Yo!	158-177
CB1988-A	Yo!	158-177
CB1988-N	Yo!	158-177
CB1993	Tuka	144-157
CB1994	Tuka	144-157
CB1999	Tuka	144-157
CB2111	Signorina	104-109
CB2117	Tuka	144-157
CB2119	Bayo	18-27
CB2120	Clelia	32-39
CB2120-A	Clelia	32-39
CB5101	Academy	182-197

## sedie home office home office chairs

CB321	Air Race	202-203
CB623	Jam	286-293
CB624	New York	322-329
CB1911	Academy	182-197
CB1695	Academy	182-197

## sedie pieghevoli folding chairs

CB205	Alu	364-365
CB207	Skip	368-369
CB208	Olivia	366-367

## sedie lounge, panche e pouf lounge chairs, benches and ottomans

CB2113	Tuka	144-157
CB2114	Tuka	144-157
CB5207	Pof	80-85
CB5208	Stulle	110-123
CB5210	Yo!	158-177

## tavoli fissi e allungabili extending and non-extending tables

CB4005-FD 120	Planet	482-485
CB4005-FD 90	Planet	482-485
CB4010-FR 110	Baron	388-397
CB4010-FR 130	Baron	388-397
CB4010-FR 160	Baron	388-397
CB4010-FR 180	Baron	388-397
CB4010-FRH 130	Baron Counter	398-399
CB4010-R 110	Baron	388-397
CB4010-R 130	Baron	388-397
CB4010-R 160	Baron	388-397
CB4010-R 180	Baron	388-397
CB4010-RH 130	Baron Counter	398-399
CB4011-R 130	Airport	372-377
CB4069-R 160	Sigma	488-493
CB4069-R 180	Sigma	488-493
CB4069-RCX 49	Sigma Consolle	532-533
CB4069-RX 180	Sigma XL	488-493
CB4082-MV 180	Royal	486-487
CB4085-R 110	Snap	498-503
CB4085-R 120	Snap	498-503
CB4085-R 130	Snap	498-503
CB4087	Sincro	494-497
CB4088-R 160	Gate	438-443
CB4088-R 180	Gate	438-443
CB4094-Q 90	Dine	408-413
CB4094-R 110	Dine	408-413
CB4094-R 120	Dine	408-413
CB4712-Q	Cocktail	518-529
CB4715-D	Cocktail	518-529

CB4716-Q	Cocktail	518-529
CB4716-R	Cocktail	518-529
CB4724-R 110 A	Eminence Metal	414-421
CB4724-R 130 A	Eminence Metal	414-421
CB4724-R 130 B	Eminence Metal	414-421
CB4724-R 160 A	Eminence Metal	414-421
CB4724-R 160 B	Eminence Metal	414-421
CB4724-R 160 C	Eminence Metal	414-421
CB4724-R 110 A	Eminence Wood	414-421
CB4724-R 130 A	Eminence Wood	414-421
CB4724-R 130 B	Eminence Wood	414-421
CB4724-R 160 A	Eminence Wood	414-421
CB4724-R 160 B	Eminence Wood	414-421
CB4724-R 160 C	Eminence Wood	414-421
CB4728-FD 120	Mikado	452-455
CB4728-FD 140	Mikado	452-455
CB4728-FR 130	Mikado	452-455
CB4728-FR 160	Mikado	452-455
CB4728-FR 180	Mikado	452-455
CB4739-D 120	Giove	444-451
CB4739-E 140	Giove	444-451
CB4742-Q 80	Aladino	378-381
CB4742-R 110	Aladino	378-381
CB4742-R 120	Aladino	378-381
CB4759-A 40	Cocktail	518-529
CB4759-A 56	Cocktail	518-529
CB4759-B 40	Cocktail	518-529
CB4759-B 56	Cocktail	518-529
CB4759-B 74	Cocktail	518-529
CB4759-FD 120	Cocktail	406-407
CB4759-FD 90	Cocktail	406-407
CB4760-A 40	Cocktail	518-529
CB4760-A 55	Cocktail	518-529
CB4760-B 40	Cocktail	518-529
CB4760-B 55	Cocktail	518-529
CB4761-B 48	Cocktail	518-529
CB4762-D	Cocktail	518-529
CB4762-Q	Cocktail	518-529
CB4762-R	Cocktail	518-529
CB4763-D	Cocktail	518-529
CB4764-Q	Cocktail	518-529
CB4764-R	Cocktail	518-529
CB4783-R 150	Athos	382-387
CB4783-R 180	Athos	382-387
CB4784-R 120	Excellence	434-437
CB4786-B 48	Cocktail	518-529
CB4787-B 56	Cocktail	518-529
CB4788-R 130	Eminence Fast	428-433
CB4788-R 160	Eminence Fast	428-433
CB4789-R 130	Mikado	456-459
CB4789-R 160	Mikado	456-459
CB4793-B 30	Stecco	518-529
CB4793-B 40	Stecco	518-529
CB4793-FD 120	Stecco	504-505
CB4793-FD 90	Stecco	504-505

CB4794-B 43	Branch	518-529
CB4795-R 160	Bold	400-405
CB4796-R 160	Wings	506-511
CB4797-R 130 A	Pentagon	466-473
CB4797-R 130 B	Pentagon	466-473
CB4797-R 160 A	Pentagon	466-473
CB4797-R 160 B	Pentagon	466-473
CB4797-R 160 C	Pentagon	466-473
CB4798-R 140	Zeffiro	512-517
CB4798-R 160	Zeffiro	512-517
CB4799-R 150	Pegaso	460-465
CB4800-R 130	Pentagon Fast	474-481
CB4800-R 160	Pentagon Fast	474-481
CB4801-R 150	Wings	506-511
CB4803-R 130	Tabla	124-129
CB4803-R 160	Tabla	124-129
CB4804-FD 120	Dix	46-51
CB4804-FD 90	Dix	46-51
CB4805-FD 120	Yo!	158-177
CB4805-FR 160	Yo!	158-177
CB4805-FR 200	Yo!	158-177
CB4806-FD 120	Stulle Table	110-123
CB4807-FD 120	Tria	134-143
CB4807-FR 160	Tria	134-143
CB4807-FR 200	Tria	134-143
CB4809-FR 160	Iron	58-63
CB4809-FR 200	Iron	58-63

## mobili cabinets tavoli e consolle pieghevoli, tavolini trasformabili folding tables and consoles, multi-purpose tables

CB07	Spazio	534-535
CB08	Quadro	86-89
CB08-A	Quadro	86-89
CB490	Mascotte	540-543
CB5041-G	Magic-J	536-539
CB5041-W	Magic-J	536-539
CB4724-RC 50	Eminence Consolle	530-531
CB4808-RC 40	Dee-J	40-45

## complementi occasionalis

CB5029	Bubbles	546-547
CB5034-G	Drop	548-549
CB5034-P	Drop	548-549
CB5061-A	Islands	544-545
CB5061-B	Islands	544-545
CB5074	Lune	550-551
CB5201	Bibli	28-31
CB5202	Ens	52-57



# DISCOVER THE CONNUBIA COLLECTION FINISHES

Tutti i materiali che utilizziamo rispettano severi standard qualitativi. I tessuti che abbiamo selezionato per voi sono piacevoli al tatto, resistono alle macchie e mantengono inalterati i colori anche dopo molto tempo. I nostri piani in ceramica hanno eccezionali caratteristiche di resistenza, sono facili da pulire e assolutamente igienici. Il legno che utilizziamo viene protetto con speciali cicli di verniciatura che offrono un'efficace barriera contro le macchie. Calligaris è inoltre certificata FSC, il marchio che identifica i prodotti contenenti legno proveniente da foreste gestite in maniera corretta e responsabile secondo rigorosi standard ambientali, sociali ed economici.

*All our materials comply with the strictest quality standards. For your pleasure, we have sourced fabrics which are not only delightfully tactile and stain-resistant, but ones which hold their colour over time. Our ceramic tops are exceptionally hard-wearing, easy to clean and utterly hygienic. Our wood is protected with special varnishing processes which create an effective barrier against staining. In addition, Connubia is FSC certified, meaning that it only uses wood that comes from well-managed forests in compliance with strict environmental, social and economic standards.*

LEGNI | WOOD TYPES

LEGNO MASSELLO | SOLID WOOD



È ottenuto direttamente dal tronco dell'albero mediante lavorazioni meccaniche. Le particolarità estetiche e di venatura sono caratteristiche dell'essenza legnosa utilizzata. Il legno massello viene finito nelle tonalità tipiche delle varie essenze con una lavorazione di verniciatura (la finitura).

Obtained by cutting the tree log through a mechanic process. The aesthetic features and grain pattern depend on the wood essence. Solid wood is usually varnished (finishing process) and reproduces the typical essence shades.

IMPIALLACCIATURE | VENEERS



Si realizzano utilizzando fogli di legno nobile di spessore variabile ricavati direttamente dai tronchi di migliore qualità. Questi vengono poi incollati su vari supporti e finiti nella tonalità di tinta desiderata. Conferiscono grande qualità ai prodotti ed un eccellente risultato estetico.

Veneer is obtained by using thin sheets of wood with different thicknesses which are taken from the best quality tree logs. Veneer layers are usually glued to a support and then stained accordingly. Veneer increases the quality of the products and delivers an excellent aesthetic result.

LAMINATI | LAMINATED FINISHES

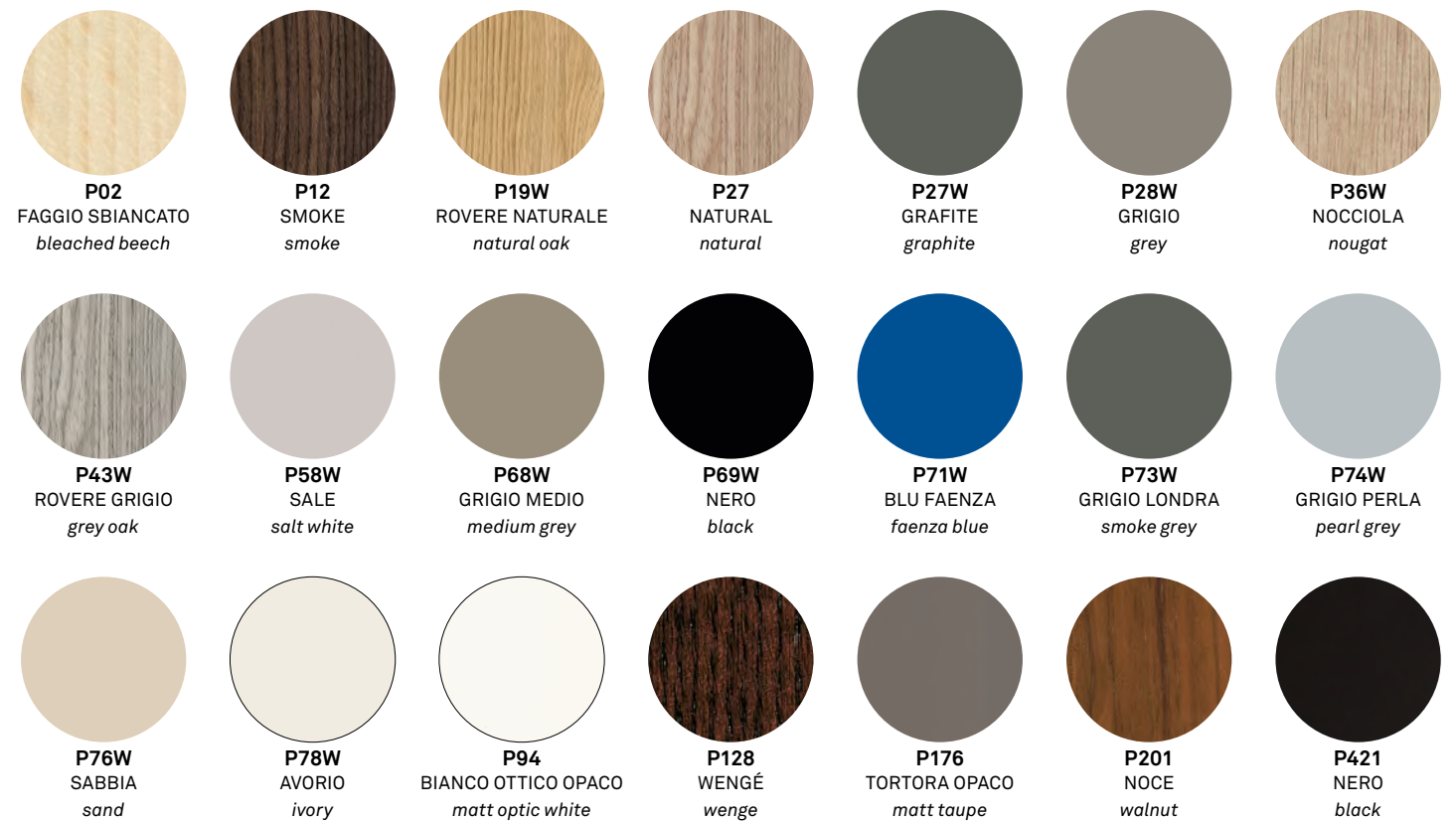

Sono rivestimenti prefiniti ottenuti incollando a pressione più strati di materiale fibroso impregnato con resine termoindurenti e spalmato sullo strato decorativo (unicolore o stampato) con resine melaminiche. Vengono quindi incollati su un pannello di particelle di legno (supporto). Garantiscono una grande varietà di soluzioni estetiche e ottime caratteristiche di stabilità, resistenza all'usura, agli urti, all'abrasione e all'umidità.

Obtained by pressure gluing various layers of fibrous material soaked in thermosetting resins and spread on the visible layer (plain coloured or patterned) with melamine resins. They are then glued on a wooden grain panel (support). Laminated panels allow a great variety of aesthetic solutions and have excellent stability, resistance to wear and tear, collisions, abrasion and humidity.

FENIX NTM® NANOTECH MATT MATERIAL

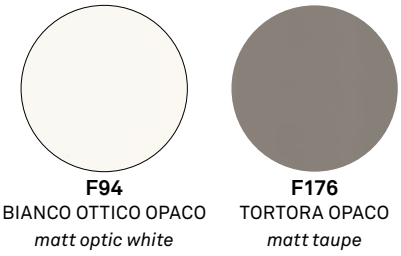

**LAMINATO FENIX NTM®**

È un materiale innovativo di Arpa Industriale creato per l'interior design. La parte esterna di FENIX NTM® è ottenuta con l'ausilio di nanotecnologie ed è caratterizzata da una superficie trattata con resine acriliche di nuova generazione, indurite e fissate attraverso il processo di Electron Beam Curing. Con una bassa riflessione della luce, la sua superficie è estremamente opaca, anti impronte digitali e piacevolmente soft touch.

An innovative material created for interior design applications by Arpa Industriale. The external surface of FENIX NTM® involves the use of nanotechnology and it is characterized by next generation acrylic resins, hardened and fixed with Electron Beam Curing process. With low light reflectivity, its surface is extremely opaque, anti-fingerprint and features a very pleasant soft touch.

LAMINATI STRATIFICATI HPL | MULTILAYER LAMINATE TOPS (HPL)

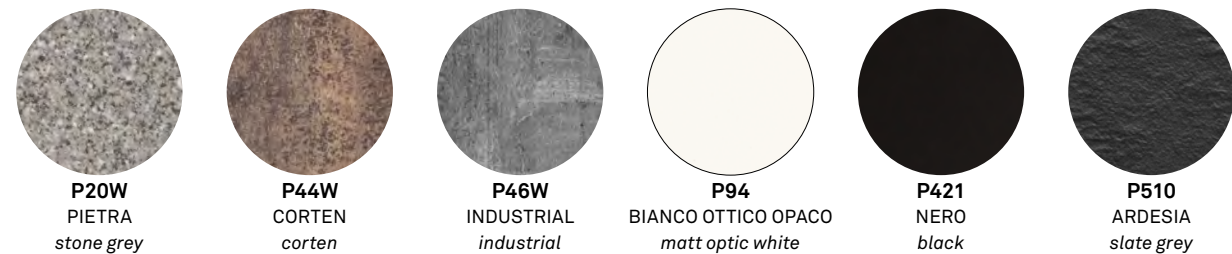

Il laminato stratificato utilizzato è un materiale autoportante di spessore 10mm costituito da più strati di materiale fibroso impregnati con resine termoindurenti e pressati tra loro ad alta pressione. La superficie esterna del pannello è realizzata in laminato decorativo a base di resine termoindurenti.

*This multilayer laminate is a 10 mm thick, self-supporting material formed with different layers of fibrous material absorbed with thermosetting resins and pressed together under high pressure. The external surface of the panel is a decorative laminate made with a base of thermosetting resins.*

NOBILITATI (SUPERFICI TERMO-STRUTTURATE) | MELAMINE FINISHES – THERMAL STRUCTURED SURFACES



Sono rivestimenti prefiniti ottenuti utilizzando carte (unicolori o stampate) impregnate e spalmate sul lato decorativo generalmente con resine melaminiche, che vengono applicati su un pannello di particelle di legno (supporto). Garantiscono una grande varietà di soluzioni estetiche, ottima stabilità e buone caratteristiche di resistenza all'usura e durata nel tempo.

*Obtained by gluing plain coloured or patterned sheets which are spread on the visible layer with melamine resins on a wooden grain panel (support). Melamine coated panels allow a great variety of aesthetic solutions, they are durable and have excellent stability and resistance to wear and tear.*

METALLI | METALS

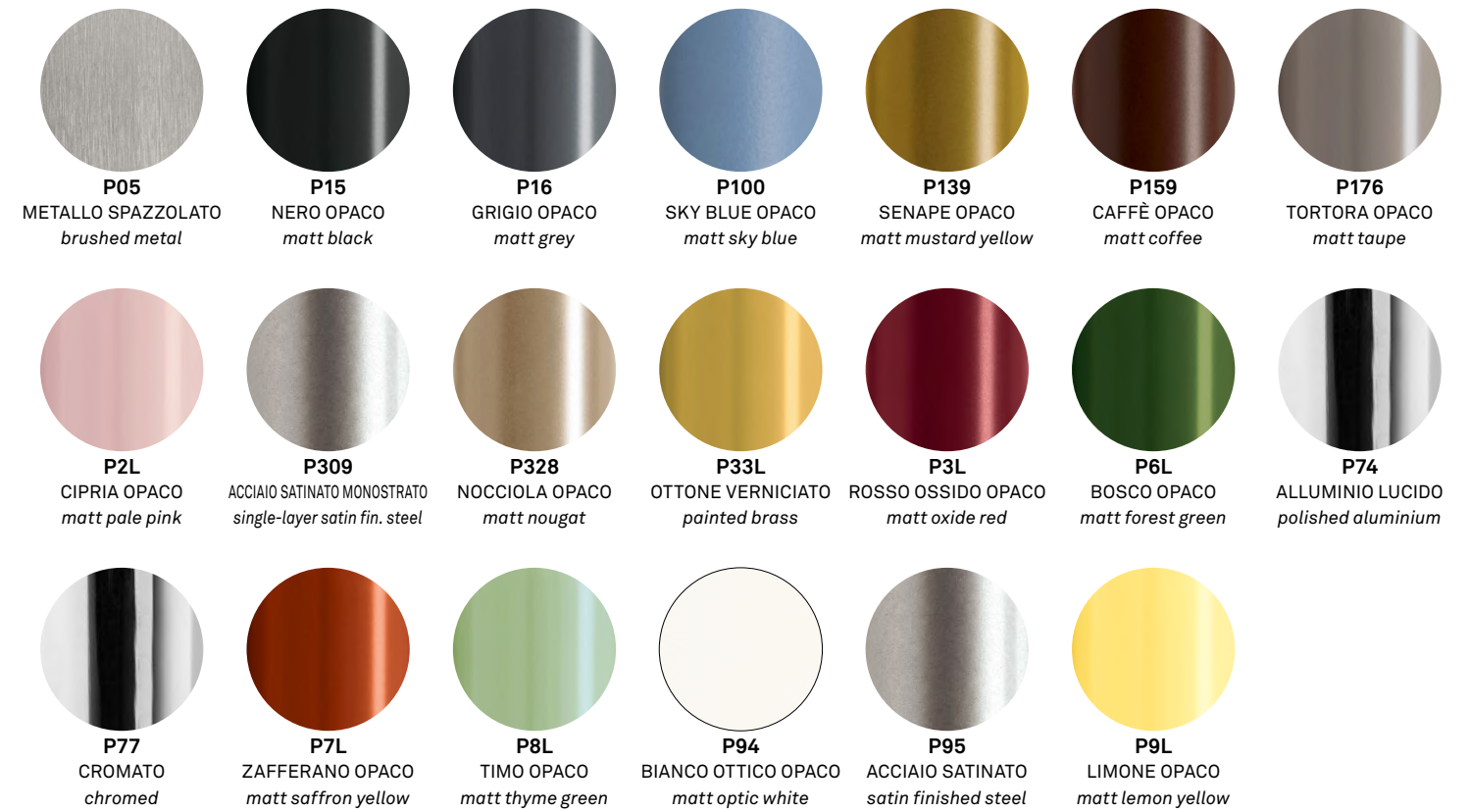

ALLUMINIO | ALUMINIUM





FINITURE LUCIDE | GLOSSY FINISHES

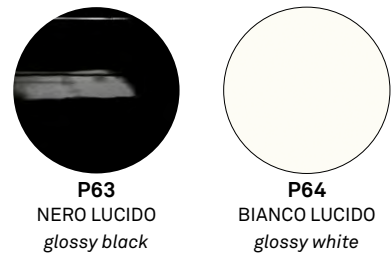

**P63**  
NERO LUCIDO  
glossy black

**P64**  
BIANCO LUCIDO  
glossy white

FINITURE OPACHE | MATT FINISHES



**P2L**  
CIPRIA OPACO  
matt pale pink

**P3L**  
ROSSO OSSIDO OPACO  
matt oxide red

**P7L**  
ZAFFERANO OPACO  
matt saffron yellow

**P8L**  
TIMO OPACO  
matt thyme green

**P15**  
NERO OPACO  
matt black

**P16**  
GRIGIO OPACO  
matt grey

**P21L**  
CANAPA OPACO  
matt hemp

**P23L**  
CIPRIA OPACO  
matt pale pink

**P24L**  
BORDEAUX OPACO  
matt burgundy

**P35L**  
ARANCIO OPACO  
matt orange

**P36L**  
SALVIA OPACO  
matt sage

**P94**  
BIANCO OTTICO OPACO  
matt optic white

**P100**  
SKY BLUE OPACO  
matt sky blue

**P151**  
CANAPA OPACO  
matt hemp

**P176**  
TORTORA OPACO  
matt taupe

**P328**  
NOCCIOLA OPACO  
matt nougat

**P900**  
TORTORA OPACO  
matt taupe

**P942**  
ARANCIO OPACO  
matt orange

**P946**  
ROSSO OPACO  
matt red

**P947**  
VERDE CHIARO OPACO  
matt light green

**P956**  
GRIGIO OPACO  
matt grey

**P973**  
SENAPE OPACO  
matt mustard yellow

MATERIALI PLASTICI | PLASTIC MATERIALS

PLASTICHE TRASPARENTI | TRANSPARENT PLASTICS

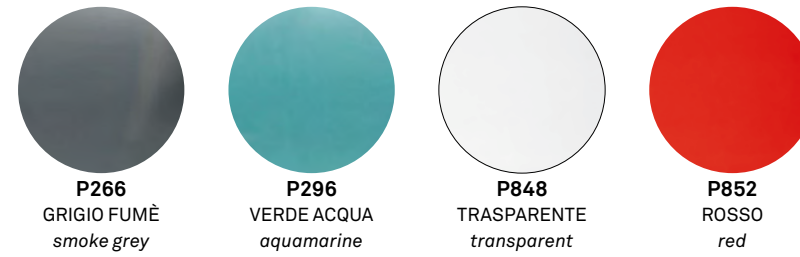

**P266**  
GRIGIO FUMÈ  
smoke grey

**P296**  
VERDE ACQUA  
aquamarine

**P848**  
TRASPARENTE  
transparent

**P852**  
ROSSO  
red

PLASTICHE COPRENTI | SOLID COLOUR PLASTICS

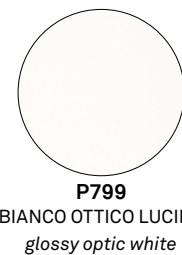

**P799**  
BIANCO OTTICO LUCIDO  
glossy optic white

PLASTICHE BICOLORE | BICOLOR PLASTICS

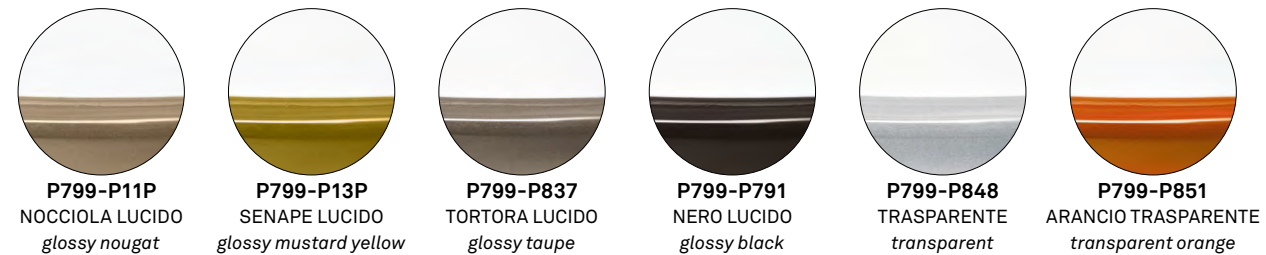

**P799-P11P**  
NOCCIOLA LUCIDO  
glossy nougat

**P799-P13P**  
SENAPE LUCIDO  
glossy mustard yellow

**P799-P837**  
TORTORA LUCIDO  
glossy taupe

**P799-P791**  
NERO LUCIDO  
glossy black

**P799-P848**  
TRASPARENTE  
transparent

**P799-P851**  
ARANCIO TRASPARENTE  
transparent orange

**MATERIALI SINTETICI LAVABILI | WASHABLE SYNTHETIC FABRICS**

**CARBON LOOK - SONOR** | 84% PVC - 11% PL - 5% PU gr/m<sup>2</sup> 640 



**481**  
CARBON LOOK  
ANTRACITE  
anthracite grey

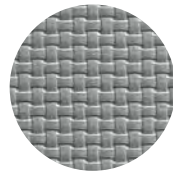

**480**  
SONOR  
ALLUMINIO  
aluminium

**NET** | 77% PVC - 23% PL gr/m<sup>2</sup> 560



**450**  
STEEL  
steel

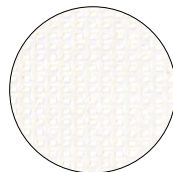

**459**  
BIANCO OTTICO  
optic white

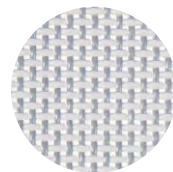

**460**  
GRIGIO  
grey

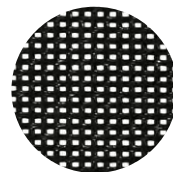

**461**  
NERO  
black

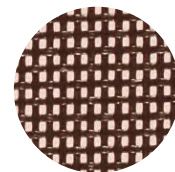

**473**  
CAFFÈ  
coffee

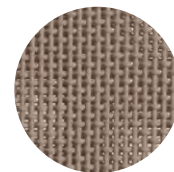

**C6A**  
TORTORA  
taupe

**NET NANCY** | 49% PVC - 42% PL - 9% CO gr/m<sup>2</sup> 587



**AV0**  
BIANCO  
white



**AV1**  
CORDA  
cord



**AV7**  
SAHARA  
sahara

**BEDFORD** | 50% PU - 50% PL gr/m<sup>2</sup> 800 



**S7K**  
TORTORA  
taupe



**S7M**  
NERO  
black



**SLY**  
SALE  
salt white

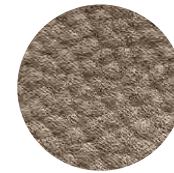

**SLZ**  
FANGO  
mud brown

**EKOS** | 55% PU - 29 CO% - 16% PL gr/m<sup>2</sup> 410 



**G8J**  
MOKA  
moka



**G8K**  
BIANCO  
white



**G8L**  
NOISETTE  
noisette



**G8N**  
NERO  
black

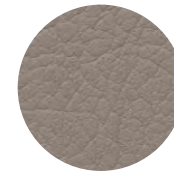

**G8Q**  
TORTORA  
taupe

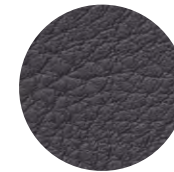

**G8R**  
GRIGIO  
grey



**G8S**  
COGNAC  
cognac

**VINTAGE** | 55% PU - 29% CO - 16% PL gr/m<sup>2</sup> 393 

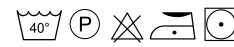

**S0A**  
DESERTO  
desert

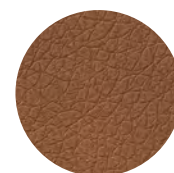

**S0B**  
TABACCO  
tobacco



**S0C**  
EBANO  
ebony



**S0W**  
CENERE  
ash grey





**S0X**  
CANAPA  
hemp

TESSUTI | FABRICS

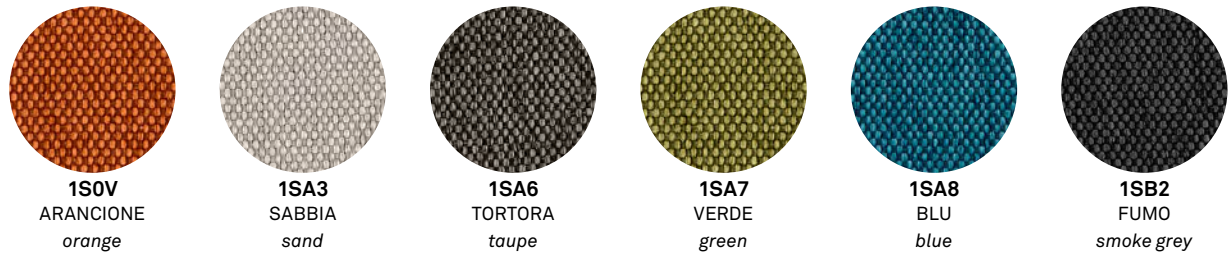
**BERNA** | 100% PL gr/m<sup>2</sup> 350 



**OSLO** | 100% CO gr/m<sup>2</sup> 328  

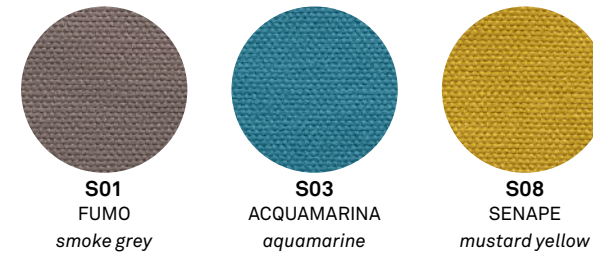

**CROS** | 100% PL gr/m<sup>2</sup> 390 



**PLAIN** | 100% CO gr/m<sup>2</sup> 515 



**MAT** | 100% PL gr/m<sup>2</sup> 457



**VENICE** | 100% PL gr/m<sup>2</sup> 430 

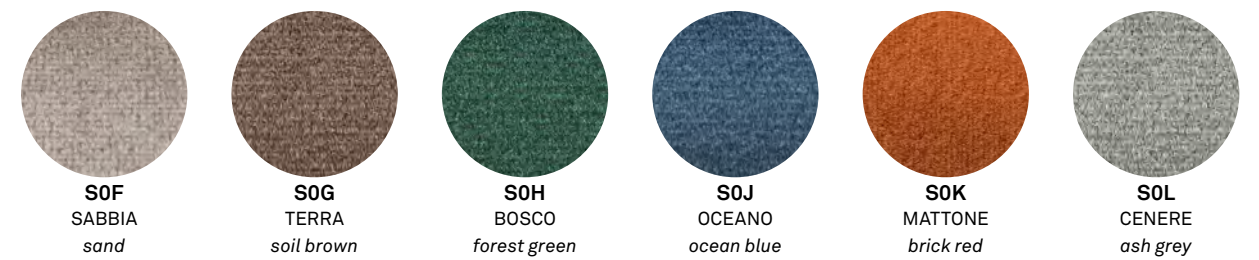

**RIGENERATO DI CUOIO/PELLE | REGENERATED LEATHER/SOFT LEATHER**

RIGENERATO DI CUOIO | REGENERATED LEATHER



Il rigenerato di cuoio è un agglomerato ottenuto dall'impasto di sfridi di pellame (minimo 60%) ed altri materiali naturali e rifinito con le stesse modalità utilizzate per il cuoio.

*Regenerated leather is the result of the mixture of leather off-cuts (min 60%) and other natural materials. Regenerated leather is finished with the same procedure used for leather.*

PELLE | SOFT LEATHER

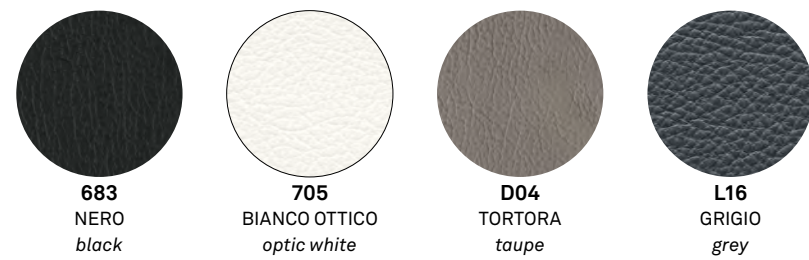

La pelle utilizzata si ottiene dalla parte più nobile del pellame (il fiore) di bovino europeo tagliato in spessori variabili secondo le esigenze e sottoposto a concia. La finitura esterna è ottenuta con pigmenti a base d'acqua.

*The leather comes from the finest part of the European ox skin (the core) cut in different thicknesses depending on the requests and then tanned. The external finish is obtained by using water based colours.*

**VETRI | GLASS OPTIONS**

VETRI | GLASS

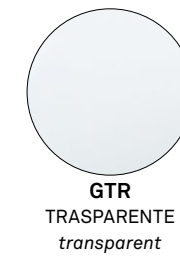

VETRI SERIGRAFATI | FROSTED GLASS

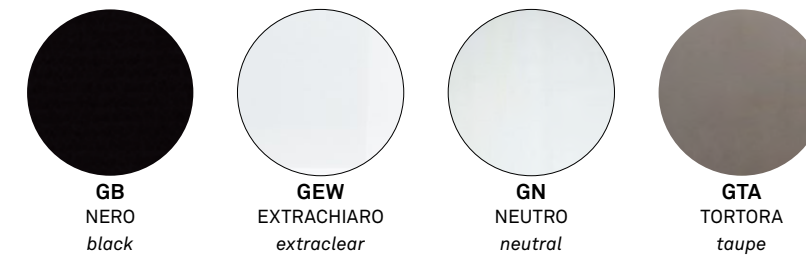

## CERAMICA | CERAMIC

## ACCOPIATO CERAMICA-VETRO | LAMINATED CERAMIC-GLASS

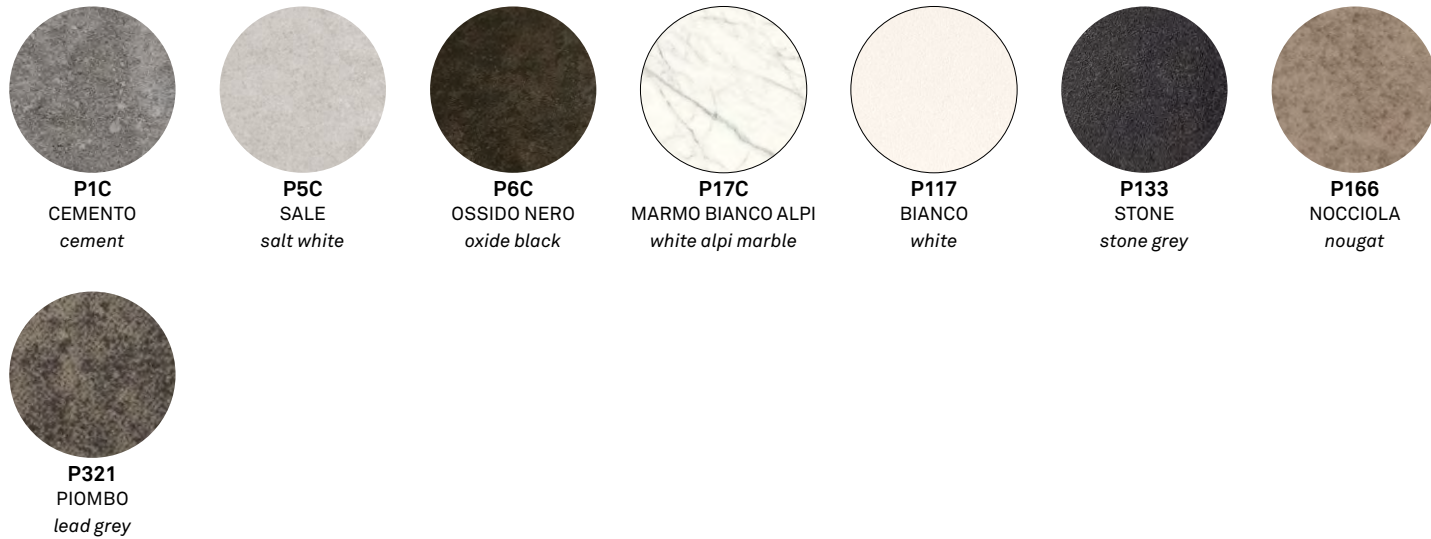

Il top ceramica-vetro è un prodotto autoportante ottenuto accoppiando, con uno speciale procedimento in autoclave, una lastra di ceramica (gres porcellanato) ad un vetro float temprato. Lo spessore della lastra di ceramica è di 3 mm, ed è accoppiata con un vetro di spessore 8 mm (totale 11 mm). Il gres porcellanato è un materiale ceramico ottenuto da materie prime di speciale pregio e purezza, macinate e colorate nell'impasto, compattate ad altissima pressione e cotte alla temperatura di 1200 °C.

Il piano di lavoro in gres porcellanato offre caratteristiche eccezionali in termini di resistenza ai graffi, agli urti, alle macchie, agli sbalzi termici ed ai prodotti chimici. È facile da pulire ed assolutamente igienico in quanto non assorbe liquidi e non rilascia sostanze nocive.

*The ceramic-glass top is a self-holding product manufactured by coupling one ceramic plate (porcelain tile) to a tempered floating glass thanks to a special process carried out in autoclave. The ceramic plate thickness is 3 mm and is coupled with an 8 mm thick glass (for a total of 11 mm). The porcelain tile is a ceramic material obtained using a mixture of stoneware composed by clay and valuable raw materials, which are mixed, body tinted, compacted whilst high pressure is applied and finally fired at 1200 °C.*

*The porcelain tile working surface features exceptional performances in terms of scratch, impact, stain, thermal shock and chemical resistance. It's easy to clean and very hygienic because it does not absorb liquids and does not release harmful substances.*

## ACCOPIATO CERAMICA-LEGNO | LAMINATED CERAMIC-WOOD



L'accoppiato ceramica-legno è un prodotto ottenuto applicando una lastra di ceramica (gres porcellanato) ad un pannello di particelle di legno con una speciale tecnica di incollaggio. Il gres porcellanato è un materiale ceramico ottenuto da materie prime di speciale pregio e purezza, macinate e colorate nell'impasto, compattate ad altissima pressione e cotte alla temperatura 1200 °C.

Il piano di lavoro in gres porcellanato offre caratteristiche eccezionali in termini di resistenza ai graffi, agli urti, alle macchie, agli sbalzi termici ed ai prodotti chimici. È facile da pulire ed assolutamente igienico in quanto non assorbe liquidi e non rilascia sostanze nocive.

*The ceramic-wood top is obtained by applying a layer of ceramic (gres porcelain tile) onto a panel made of wooden particles with a special gluing technique. The porcelain tile is a ceramic material obtained using a mixture of stoneware composed by clay and valuable raw materials, which are mixed, body tinted, compacted whilst high pressure is applied and finally fired at 1200 °C.*

*The porcelain tile working surface features exceptional performances in terms of deep abrasion, stain, thermal shock and chemical resistance. It's easy to clean and very hygienic because it does not absorb liquids and does not release harmful substances.*



Via Trieste, 12  
33044 Manzano  
(Udine) Italy  
Ph. +39 0432 748211

[connubia@connubia.it](mailto:connubia@connubia.it)

[connubia.com](http://connubia.com)

Copyright © Calligaris S.p.A.

CAMPIONE PROMOZIONALE GRATUITO NON DESTINATO ALLA VENDITA - ESCLUSO IVA ART. 2 COMMA 3 LETTERA C DPR 633/72 ESONERATO DALLA BOLLA DI ACCOMPAGNAMENTO ART. 4 PUNTO 6 DPR 627/78  
FREE PROMOTIONAL SAMPLE - VAT NOT INCLUDED ART. 2 PAR. 3 LETTER C DPR 633/72 - NO TRANSPORT DOCUMENTS REQUIRED ART. 4 ITEM 6 ART 627/78 - STAMPA / PRINT 05/2020

