

YOUR
OWN
STYLE
SHOWER
ENCLOSURES

 **inda**[®]
bathroom Interiors

INDEX

Your own style.

HISTORY	2
TOTAL LIVING	4
YOUR OWN COLOR	6
WALK IN COULISSANTE	8
WALK IN	18
INDISSIMA WALK IN	34
INDISSIMA ALU	40
INDISSIMA	48
AZURE	58
PRAIA DESIGN	66
CLAIRE DESIGN	78
AIR	94
KLAR	100
TRENDY DESIGN	106
SOPRAVASCA	116
FINISHES	124
SYMBOL KEY	127

HISTORY

4 production sites for 4 categories of items

ACCESSORI DA BAGNO
SPECCHI TECNOLOGICI
MOBILI DA BAGNO
PARETI DOCCIA

ACCESSOIRES DE SALLE DE BAIN
MIROIRS TECHNOLOGIQUES
MEUBLES DE SALLE DE BAINS
PAROIS DE DOUCHE

BATHROOM ACCESSORIES
TECHNOLOGICAL MIRRORS
BATHROOM CABINETS
SHOWER ENCLOSURES

Inda, Gruppo Industriale italiano del settore arredobagno, con i suoi 70 anni d'esperienza è, dal 1944, al servizio di chi desidera arredare il proprio ambiente bagno con stile e funzionalità. La capacità del Gruppo di cogliere le esigenze ed i gusti di un pubblico eterogeneo in continuo cambiamento e di anticipare le tendenze dell'abitare, gli ha permesso di consolidare la leadership nei mercati internazionali.

Sono quattro le divisioni di prodotto del Gruppo: mobili, pareti doccia, accessori e specchi, tutte di produzione interna nelle quattro fabbriche Inda, per formare un pensiero unico, ideale per infinite soluzioni d'arredamento della sala da bagno. Creatività, originalità, distintiva eleganza sono elementi caratterizzanti che si esprimono nel design Inda attraverso tutte le sue forme, dal classico, al moderno, alle soluzioni più all'avanguardia, che rispondono armoniosamente all'evoluzione dell'abitare. Un progetto globale che si declina in ogni situazione architettonica, grazie all'eccezionale versatilità e dedizione delle proprie risorse creative e produttive.

Inda est un groupe industriel italien spécialisé dans l'aménagement des salles de bains avec 70 années d'expérience au service de tous ceux qui souhaitent meubler leur salle de bains avec style et fonctionnalité. La capacité du groupe à satisfaire les besoins et les goûts d'un public hétérogène en constante évolution et à anticiper les tendances de la décoration d'intérieur lui ont permis de consolider la leadership sur les marchés internationaux. Il existe quatre divisions de produits du Groupe : meubles, parois de douche, accessoires et miroirs, tous de production

interne dans les quatre usines Inda, pour former un concept unique, idéal pour des solutions à l'infini d'ameublement de salle de bains. La créativité, l'originalité, l'élégance qui le distingue sont des caractéristiques qui se reflètent dans la conception d'Inda sous toutes les formes : du classique au moderne, aux solutions d'avant-garde qui s'adaptent harmonieusement à l'évolution des foyers. Un projet global qui se décline dans toutes les solutions architectoniques grâce à la versatilité exceptionnelle et au dévouement des propres ressources créatives et productives.

Since 1944, with over 70 years of experience, Inda - Italian producer of bathroom furniture, accessories and shower enclosures - has been helping its customer to stylish and ergonomically furnish their bathrooms.

The Group's ability to capture the needs and tastes of a diverse, constantly-changing public and anticipate current trends has helped it consolidate its leading place in international markets.

The Group counts four categories of items: cabinets, shower enclosures, accessories and mirrors, all of them produced internally in Inda's four production sites, to shape a unique concept, ideal for endless decor solutions of your bathroom. Inda's design arises from creativity, originality and distinctive elegance expressing on all styles from classic to modern, to the most avant-garde solutions, that respond harmoniously to the way living evolves. It is a global project that comes through in every architectural situation thanks to the exceptional versatility and dedication of its creative and productive resources.





INDA MILANO

More than a showroom

VIA PIER LOMBARDO, 30
CORNER VIA TIRABOSCHI
MILANO
indamilano@inda.net

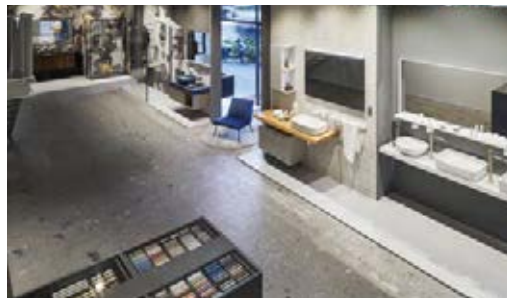

TOTAL LIVING

A bathroom with a coordinated aesthetics.

Il bagno, oggi più che mai, è diventato uno spazio imprescindibile del nostro ambiente domestico, passando da un luogo di servizio a una vera e propria esperienza totalizzante.

Per questo motivo, Inda propone diverse soluzioni di abbinamento estetico riguardanti diverse categorie di prodotto, per arredare il tuo bagno con un'estetica coordinata. Pareti doccia, mobili, accessori, specchi: tutto è perfettamente abbinato.

La salle de bains est désormais un espace indispensable dans nos foyers. C'est bien plus qu'une simple pièce de service, c'est une véritable expérience complète de notre quotidien. C'est pour cette raison qu'Inda propose diverses combinaisons d'ordre esthétique dans plusieurs catégories de produits pour meubler votre salle de bains de manière esthétique et coordonnée.

Les parois de douche, le meubles et les accessoires sont parfaitement coordonné

Today more than ever, bathrooms have become an essential space in our home environment, going from being somewhere to freshen up to a real all-encompassing experience.

This is why Inda offers different matching aesthetic solutions for different product categories to furnish your bathroom with a coordinated look. Shower enclosures, furniture, accessories, mirrors: everything fits perfectly together.







Freedom of being

Inda propone un'unica soluzione cromatica per tutta la stanza da bagno, con 15 colori opachi selezionati per:

- le pareti doccia WALK IN e CLAIRE DESIGN
- gli accessori LEA, GEALUNA, MY LOVE e MY SECRET
- specchi PIRANO, MAGGIORE, TENNO, ZARA e SPALATO

da abbinare alle stesse finiture mobili e piani top, ai lavabi integrati Giotto e ai lavabi in appoggio in mineralguss.

Inda propose une solution de couleur unique pour toute la salle de bain, avec 15 couleurs opaques sélectionnées pour :

- les parois de douche WALK IN et CLAIRE DESIGN
- les accessoires LEA, GEALUNA, MY LOVE et MY SECRET
- miroirs PIRANO, MAGGIORE, TENNO, ZARA et SPALATO

à combiner avec les mêmes finitions des meubles, plans top des meubles, avec les lavabos Giotto intégré et aux lavabos en mineralguss.

Inda suggests an entire colour solution for your bathroom, with 15 selected matt shades for:

- WALK IN and CLAIRE DESIGN shower enclosures
- LEA, GEALUNA, MY LOVE and MY SECRET accessories
- PIRANO, MAGGIORE, TENNO, ZARA and SPALATO mirrors

to be combined with the same finishes of cabinets and worktops, Giotto integrated washbasins and tabletop washbasins in mineral marble.



GF
Laccato opaco Grafite
Laqué mat Grafite
Mat lacquered Grafite



TN
Laccato opaco Titanio
Laqué mat Titanio
Mat lacquered Titanio



BD
Laccato opaco Blu denim
Laqué mat Blu denim
Mat lacquered Blu denim



AV
Laccato opaco Avio
Laqué mat Avio
Mat lacquered Avio



PT
Laccato opaco Platino
Laqué mat Platino
Mat lacquered Platino



CX
Laccato opaco Creta
Laqué mat Creta
Mat lacquered Creta



ST
Laccato opaco Seta
Laqué mat Seta
Mat lacquered Seta



MP
Laccato opaco Perla
Laqué mat Perla
Mat lacquered Perla



AX
Laccato opaco Avorio
Laqué mat Avorio
Mat lacquered Avorio



VV
Laccato opaco Verde salvia
Laqué mat Verde salvia
Mat lacquered Verde salvia



VF
Laccato opaco Verde felce
Laqué mat Verde felce
Mat lacquered Verde felce

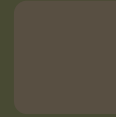

BN
Laccato opaco Bruno
Laqué mat Bruno
Mat lacquered Bruno



VN
Laccato opaco Avana
Laqué mat Avana
Mat lacquered Avana



VS
Laccato opaco Visone
Laqué mat Visone
Mat lacquered Visone



TL
Laccato opaco Terra di Luna
Laqué mat Terra di Luna
Mat lacquered Terra di Luna



WALK IN COULISSANTE

The combination between practicality and design.

Una soluzione per ogni tipologia di spazio, pensata per chi vuole una parete doccia walk-in che offra la protezione completa degli schizzi nella sua massima estensibilità. Il telaio ridotto al minimo, l'assenza del binario superiore, la maniglia intagliata nel vetro e la possibilità di ridurre l'ingombro sottolineano il suo aspetto minimale. Definita l'evoluzione della serie Walk-in per il suo ampio ingresso, diventa anche porta scorrevole in nicchia o abbinata a parete fissa.

Une solution pour chaque type d'espace, conçue pour ceux qui veulent une douche walk-in qui offre une protection complète contre les éclaboussures dans son extensibilité maximale.

Le cadre réduit au minimum, l'absence de traverse supérieure, la poignée taillée dans le verre et la possibilité de réduire sa taille soulignent son aspect minimal. Ayant défini l'évolution de la série Walk-In grâce à sa grande entrée, elle devient également une porte coulissante pour niche ou combinée avec une paroi fixe.

A solution for any room and for those looking for a Walk-In shower enclosure that offers a complete protection of splashes in its maximum extensibility. A minimal frame, the absence of upper track, a handle obtained with a hole in the glass wall and the possibility to reduce its volume underline its basic nature.

Keeping its wide entrance as the main feature, our Walk-In series enlarges its options with the sliding door for installation in niche, or combined with a fixed panel.





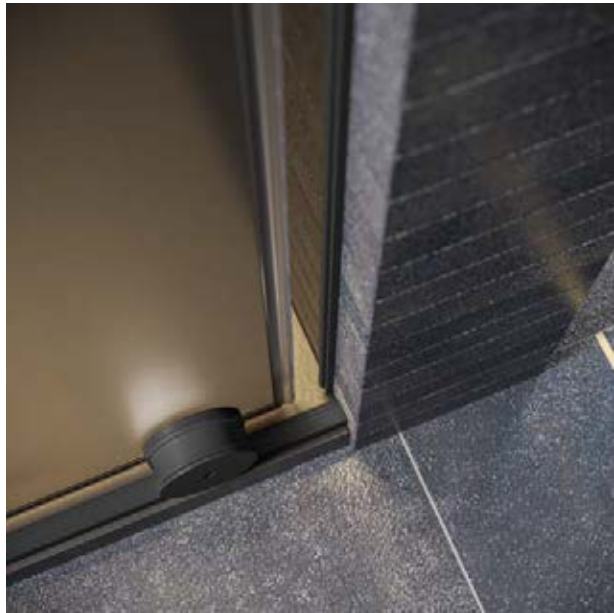

10_WALK IN COULISSANTE





12_WALK IN COULISSANTE

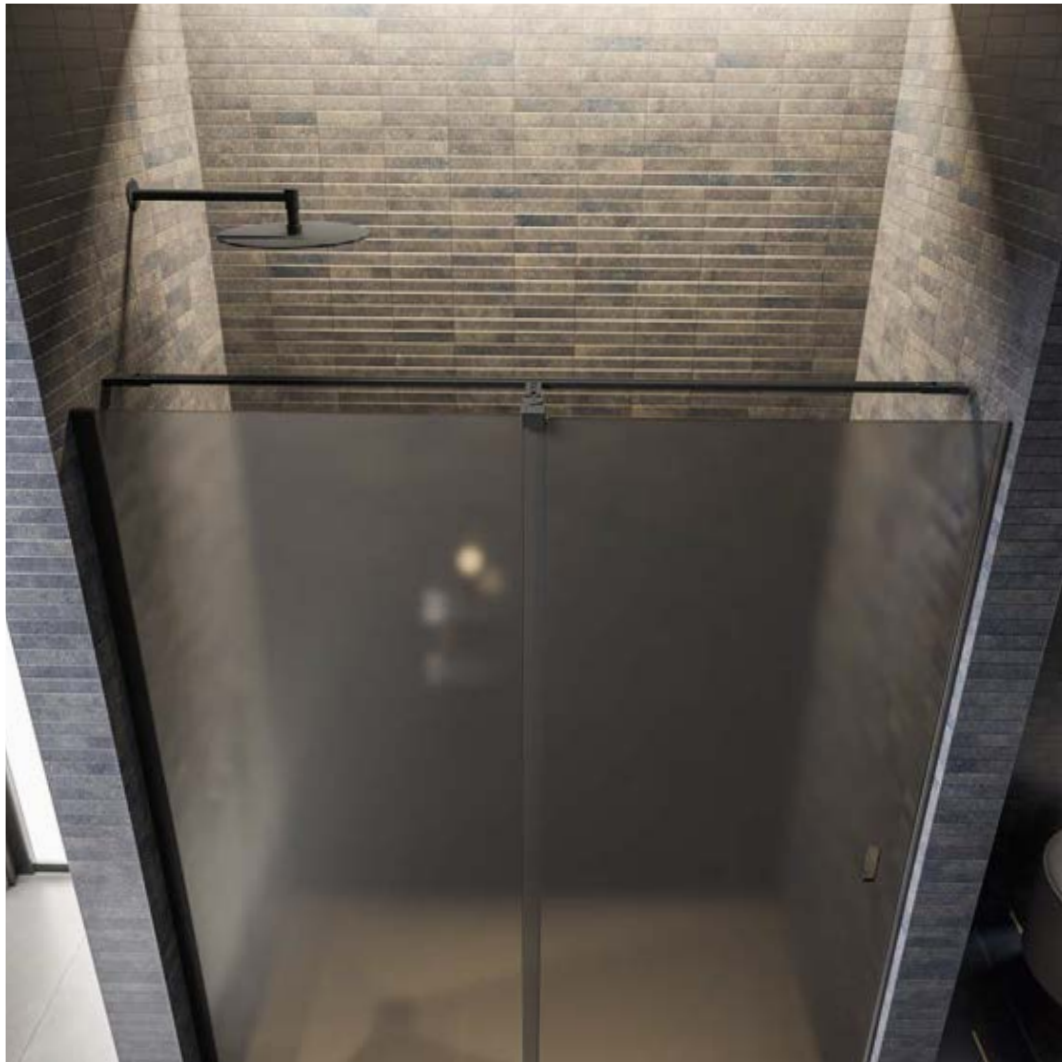
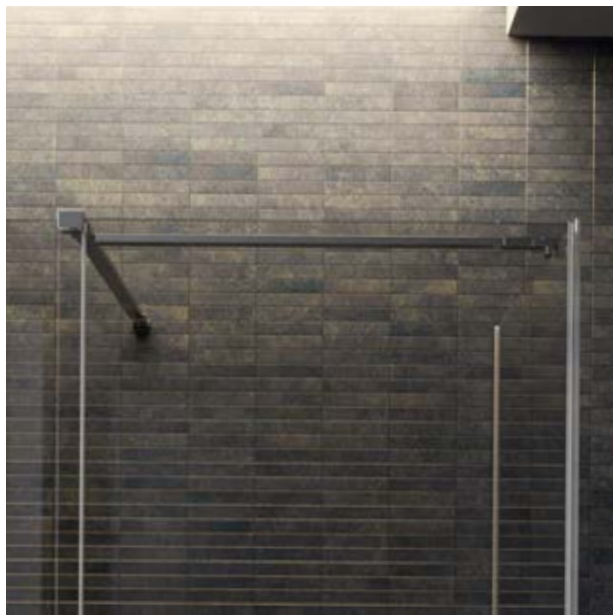





Angolare
Accès d'angle
Comer

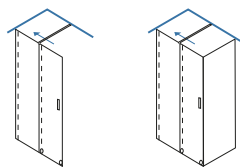

H200

8mm

6mm



Nicchia
Niche
Niche

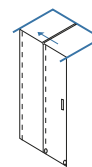

H200

8mm

6mm



Telaio
Profilé
Frame



AN
Tipo cromato anodizzato naturale lucido
Type chromé anodisé naturel brillant
Natural polished anodized chrome type

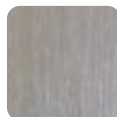

AC
Nickel spazzolato
Nickel brossé
Brushed nickel



WM
Bianco opaco
Blanc mat
White mat



BM
Nero opaco
Noir mat
Black mat

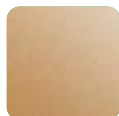

OR
Oro rosato lucido
Doré rosé brillant
Glossy rose-coloured gilded



BZ
Bronzo
Bronze
Bronzed

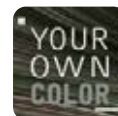

YOUR OWN COLOR
> page 6

Vetro
Verre
Glass



01
Trasparente
Transparent
Transparent



14
Grigio
Gris
Grey



41
Ice Grigio
Ice Gris
Ice Grey

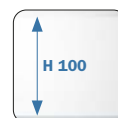

73
Trasparente con fascia serigrafata
Transparent avec bande sérigraphiée
Transparent with silk screen printed band



STANDARD

Foro rettangolare su lastra.
Trou rectangulaire sur plaque.
Rectangular hole on plate.



OPTIONAL

Cromato
Chromé
Chrome type



OPTIONAL

Nickel spazzolato
Nickel brossé
Brushed nickel



OPTIONAL

Oro rosato lucido
Doré rosé brillant
Glossy rose-coloured gilded



OPTIONAL

Bianco opaco
Blanc mat
White mat



OPTIONAL

Nero opaco
Noir mat
Black mat



OPTIONAL

Bronzo
Bronze
Bronzed



OPTIONAL

YOUR OWN COLOR
> page 6

DESIGN BY STUDIO INDA

WALK IN

Free space.

Walk In: un programma completo dove libertà compositiva e varietà estetica suggeriscono una nuova libertà di interpretazione per soluzioni complete che esplorano stili di vita differenti. Lastre di cristallo e staffe di rinforzo cromate si uniscono in un sistema che interpreta la parete doccia come uno spazio libero da porte, di immediato accesso e fruizione.

Walk In: un programme complet où la liberté de composition et la variété d'exposition suggèrent une nouvelle liberté d'interprétation pour des solutions complètes qui explorent différent style de vie. Plaques de verre et bras de renfort chromés s'unissent à un système qui interprète la paroi de douche libre de toute porte, accès immédiat.

Walk In: a complete program where composing freedom and esthetic variety suggest a new interpreting freedom for complete solutions that explore different lifestyles. Crystal slabs and chrome reinforcing brackets are joined in a system that interprets the shower wall like a free space free of doors, for immediate access and easy use.







20_WALK IN





22_WALK IN





24_WALK IN







26_WALK IN



Pareti
Parois
Panels

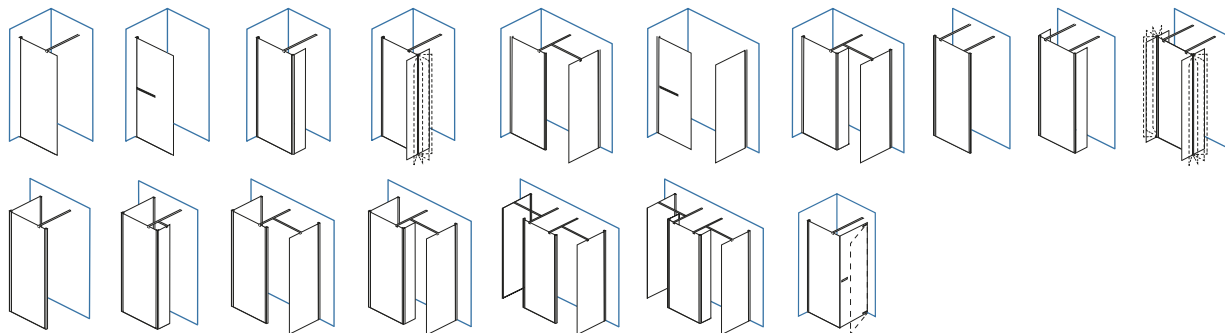

H200

8mm



Pareti
Parois
Panels

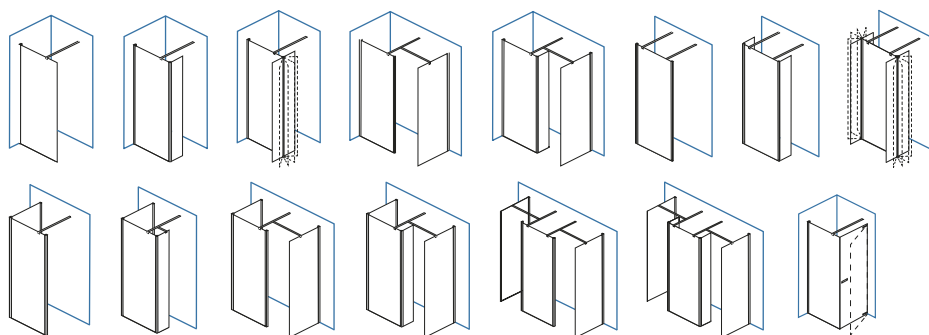

H200

6mm



Telaio
Profilé
Frame



AN
Tipo cromato anodizzato naturale lucido
Type chromé anodisé naturel brillant
Natural polished anodized chrome type

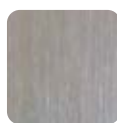

AC
Nickel spazzolato
Nickel brossé
Brushed nickel

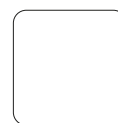

WM
Bianco opaco
Blanc mat
White mat



BM
Nero opaco
Noir mat
Black mat

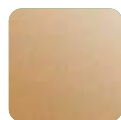

OR
Oro rosato lucido
Doré rosé brillant
Glossy rose-coloured gilded



BZ
Bronzo
Bronze
Bronzed

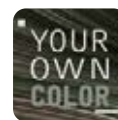

YOUR OWN COLOR
> page 6

Vetro
Verre
Glass



01
Trasparente
Transparent
Transparent



14
Grigio
Gris
Grey



41
Ice Grigio
Ice Gris
Ice Grey

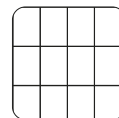

DG
Verrière



73
Trasparente con fascia serigrafata
Transparent avec bande sérigraphiée
Transparent with silk screen printed band



80
Ice



90
Specchio
Miroir
Mirror

Maniglia
Poignée
Handle



Cromato
Chromé
Chrome type

Finitura maniglia in abbinamento alla
finitura telaio.

Finition de la poignée en combinaison
avec la finition du cadre.

Finish of the handle in combination
with the finish of the frame.



Nichel spazzolato
Nickel brossé
Brushed nickel



Oro rosato lucido
Doré rosé brillant
Glossy rose-coloured gilded

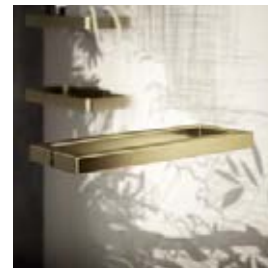

Bronzo
Bronze
Bronzed



Bianco opaco
Blanc mat
White mat



Nero opaco
Noir mat
Black mat



YOUR OWN COLOR
> page 6

Esempi di come comporre la barra modulare

Exemples de comment composer la barre modulaire

Examples of how to compose the modular bar

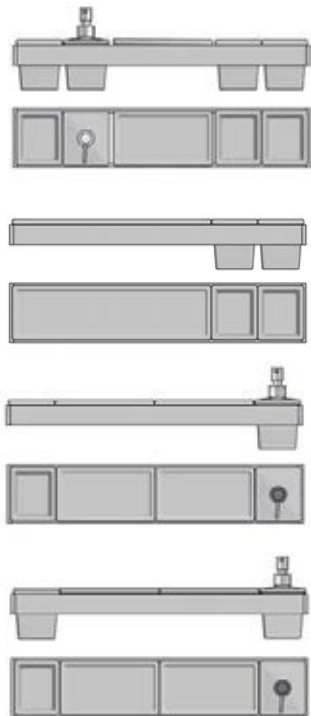

Accessori
Accessoires
Accessories



cod. R49110



cod. R49100



cod. R49120

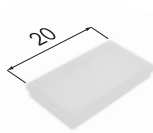

cod. R58110

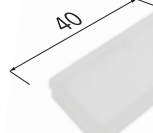

cod. R58510

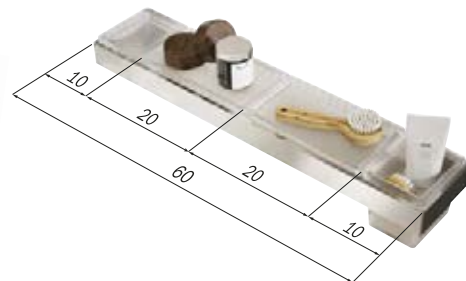



Kit di installazione
Bras de renfort
Installation kit



Kit di installazione pavimento/soffitto
Kit pour installation sol/plafond
Installation kit floor/roof

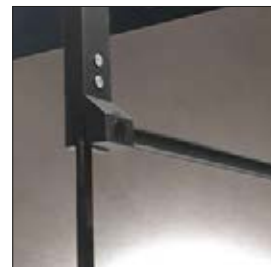

Kit di installazione vetro/soffitto
Kit pour installation verre/plafond
Installation kit glass/roof

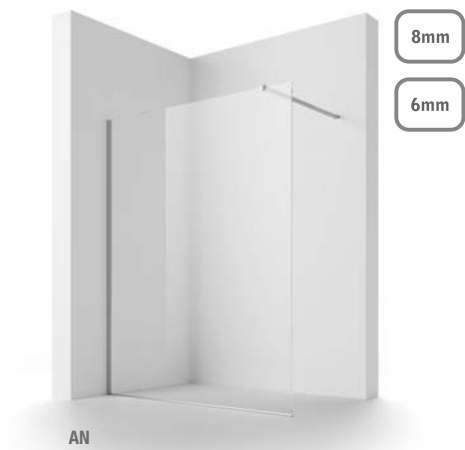



DESIGN BY MATTEO THUN AND ANTONIO RODRIGUEZ

INDISSIMA WALK IN

Stylistic elegance.

Indissima diventa walk in!

La barra modulare accessori si trasforma in braccio di rinforzo per una nuova concezione di parete doccia. L'assenza di strutture superiori esalta la sua essenzialità estetica, caratteristica principale di tutta la serie disegnata da Matteo Thun e Antonio Rodriguez.

Indissima Walk-in rispecchia la personalizzazione della barra accessori anche nella versione doccia, con differenti moduli e finiture disponibili.

Indissima devient walk-in !

La barre d'accessoires modulable se transforme en bras de renfort pour un nouveau concept de paroi de douche. L'absence de structures supérieures renforce son caractère esthétique essentiel, caractéristique principale de toute la série conçue par Matteo Thun et Antonio Rodriguez.

Indissima Walk-in reflète la personnalisation de la barre d'accessoires également dans la version douche, avec différents modules et finitions disponibles.

Indissima becomes Walk-In!

The modular bar for accessories becomes a reinforcement arm for a new concept of shower enclosure. The absence of upper brackets helps arising its aesthetic simplicity – the main feature of the entire series designed by Matteo Thun and Antonio Rodriguez.

Indissima Walk-In keeps the customisation of the accessories modular bar also inside the shower enclosure, with different modules and finishes.







36_INDISSIMA WALK IN



Pareti
Parois
Panels

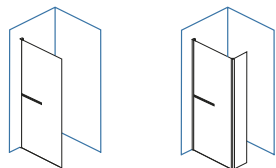

H200

6mm



Telaio
Profilé
Frame



NS
Acciaio inox spazzolato
Acier inoxydable brossé
Brushed stainless steel

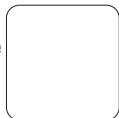

WM
Bianco opaco
Blanc mat
White mat



BM - NE
Nero opaco
Noir mat
Black mat

Vetro
Verre
Glass



01
Trasparente
Transparent
Transparent



14
Grigio
Gris
Grey

Qualità del prodotto
Qualité du produit
Product quality



Inda Glass Protection
Trattamento per la protezione anticalcare del vetro, di serie.
Traitement pour la protection du verre, série.
Anti limescale glass protection treatment, standard.

Esempi di come comporre la barra modulare

Exemples de comment composer la barre modulaire

Examples of how to compose the modular bar

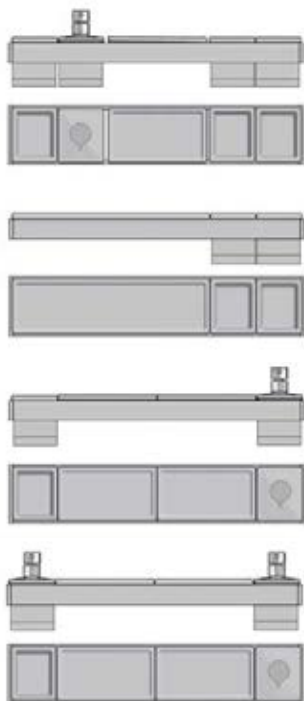

Accessori
Accessoires
Accessories



cod. A8851NNS
cod. A8851NWM
cod. A8851NNE



cod. A8810MNS21
cod. A8810MWM21
cod. A8810MNE21



cod. A8812MNS21
cod. A8812MWM21
cod. A8812MNE21



cod. A8851MNS
cod. A8851MWN
cod. A8851MNE

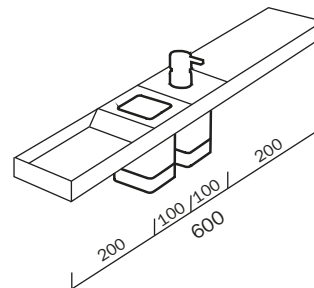

INDISSIMA ALU

Design and elegance.

Dallo stile raffinato e dal design di Indissima, nasce la versione Alu che permette massima flessibilità di installazione e una gamma diversificata di finiture. Un'ottima scelta quando si vuole unire praticità e design.

Influenced by the refined style and the design of Indissima, the Alu version sees the light: it allows an extreme flexibility of installation and a colourful palette of finishes. An excellent choice when you want to combine practicality and design.

Du style et du design raffinés d'Indissima naît la version Alu qui permet une flexibilité d'installation maximale et une gamme diversifiée de finitions. Un excellent choix lorsque vous souhaitez allier praticité et design.











44_INDISSIMA ALU



Angolare
Accès d'angle
Corner

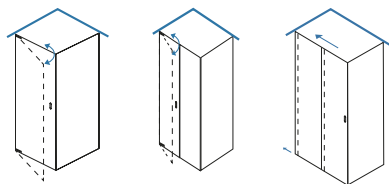

H200

8mm

6mm



Nicchia
Niche
Niche

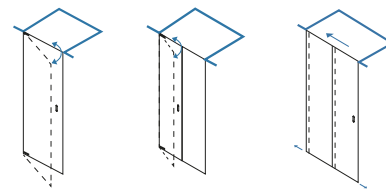

H200

8mm

6mm



Telaio
Profilé
Frame



AN
Tipo cromato anodizzato naturale lucido
Type chromé anodisé naturel brillant
Natural polished anodized chrome type



BZ
Bronzo
Bronze
Bronzed

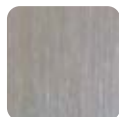

AC
Nickel spazzolato
Nickel brossé
Brushed nickel

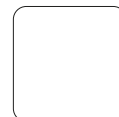

WM
Bianco opaco
Blanc mat
White mat



BM
Nero opaco
Noir mat
Black mat

Vetro
Verre
Glass



01
Trasparente
Transparent
Transparent



14
Grigio
Gris
Grey

Qualità del prodotto
Qualité du produit
Product quality



Inda Glass Protection
Trattamento per la protezione anticalcare del vetro, di serie.
Traitement pour la protection du verre, série.
Anti limescale glass protection treatment, standard.

Maniglia
Poignée
Handle



STANDARD

Foro rettangolare su lastra.
Trou rectangulaire sur plaque.
Rectangular hole on plate.

Cerniera
Charnière
Hinge

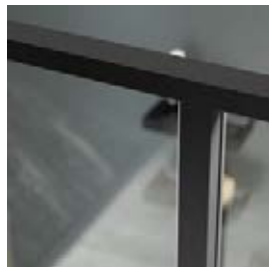

Profilo magnetico di chiusura in alluminio su porte scorrevoli. Lo stesso, a scomparsa a triplo magnete su porte battenti.

Profil de fermeture magnétique en aluminium sur les portes coulissantes. La même sur la version escamotable avec triple aimant sur les portes battantes.

Aluminium profile for a magnetic closure of sliding doors. The same profile has three hidden magnets on pivot doors.



Cerniere pivot e cuscinetti incollati con tecnologia UV (facilità di pulizia e impatto estetico).

Charnières à pivotantes et roulements de coulissements encollés avec la technologie UV (facilité de nettoyage et impact esthétique).

Pivot hinges and ball bearings glued with UV technology (easy cleaning and aesthetical impact).

Telaio
Profilé
Frame



Taglio a 45° dei profili superiori e inferiori per un'eleganza formale.

Coupe à 45° des profils supérieurs et inférieurs pour une élégance formelle.

Upper and lower profiles with a 45-degree cut, thus giving a formal elegance.



Porta scorrevole in linea con la parete fissa per angolo.

Porte coulissante alignée avec le paroi fixe pour combinaison en angle.

Sliding door aligned with the fixed panel for a corner combination.

DESIGN BY MATTEO THUN AND ANTONIO RODRIGUEZ

INDISSIMA

Shower enclosures.

Indissima capovolge il paradigma stesso di chiusura doccia. Struttura portante inferiore, che sostiene il concetto estremo di telaio minimale. La più sottile linea telaio presente sul mercato, da luce al volume rigoroso ed elegante di una parete doccia che arreda lo spazio.

Indissima renverse le paradigme même de la fermeture de douche. Structure de support inférieure, qui soutient le concept extrême de cadre minimal. La ligne de cadre la plus fine du marché, mets en lumière le volume rigoureux et l'élégance d'une paroi de douche qui donne de l'espace.

Indissima overturns the very paradigm of shower closure. Lower supporting structure, which supports the extreme concept of minimal frame. The thinnest frame line on the market, bring to light the rigorous and elegant volume of a shower enclosure that furnishes the space.

















Angolare
Accès d'angle
Corner

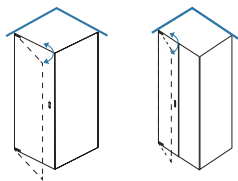

H200

8mm

6mm



Nicchia
Niche
Niche

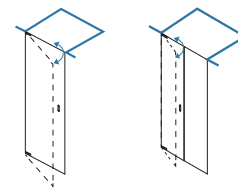

H200

8mm

6mm



Telaio
Profilé
Frame



NS
Acciaio inox spazzolato
Acier inoxydable brossé
Brushed stainless steel

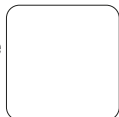

WM
Bianco opaco
Blanc mat
White mat



BM
Nero opaco
Noir mat
Black mat

Vetro
Verre
Glass



01
Trasparente
Transparent
Transparent



14
Grigio
Gris
Grey

Qualità del prodotto
Qualité du produit
Product quality



Inda Glass Protection
Trattamento per la protezione anticalcare del vetro, di serie.
Traitement pour la protection du verre, série.
Anti limescale glass protection treatment, standard.

Maniglia
Poignée
Handle



STANDARD

Foro rettangolare su lastra.
Trou rectangulaire sur plaque.
Rectangular hole on plate.



OPTIONAL

Acciaio inox spazzolato
Acier inoxydable brossé
Brushed stainless steel



OPTIONAL

Bianco opaco
Blanc mat
White mat



OPTIONAL

Nero opaco
Noir mat
Black mat

Cerniera
Charnière
Hinge



Cerniere agli estremi lastra incollate con tecnologia UV.

Charnières aux extrémités du verre liées par la technologie UV.

Hinges at the ends of the slab bonded with UV technology.



Cerniere agli estremi filo esterno telaio ad apertura esterna ed interna.

Charnières sur le bord extérieur du cadre avec ouverture externe et interne.

Hinges on the outer edge of the frame with external and internal opening.

Telaio
Profilé
Frame



Telaio inox inferiore portante in linea con struttura accessori. Carter interno copri viti.

Cadre inférieur en acier inoxydable, aligné avec la structure des accessoires. Couvercle interne pour vis.

Lower supporting stainless steel frame in line with accessory structure. Internal cover for screws.



Telaio inox superiore minimale in linea con struttura mobili. Telaio inox superiore estremizzato (solo 15 mm).

Cadre supérieur en acier inoxydable minimal aligné avec la structure mobile. Cadre supérieur en acier inoxydable (15 mm seulement).

Minimal upper stainless steel frame in line with mobile structure. Extremely stainless steel upper frame (only 15 mm).

AZURE

The new dimension of shower space.

Tecnica ed estetica raggiungono un nuovo equilibrio, Azure la nuova dimensione dello spazio doccia Inda. Gamma di porte battenti Frameless da 8mm personalizzabili secondo le diverse proposte di maniglie e cerniere, in estetica coordinata con mobili e accessori Inda. Cerniere incollate mediante tecnica UV, filo interno vetro, nuova barra di sostegno, due tipologie di fissaggio a muro, il tutto per una doccia cucita a misura di cliente.

Technique et esthétique atteignent un nouvel équilibre, Azure la nouvelle dimension de l'espace douche Inda. Gamme de portes battantes 8mm Frameless personnalisées selon différentes propositions pour les poignées et les charnières, ayant un esthétisme coordonné avec les meubles et les accessoires Inda. Charnières encollage par la technique UV, au ras du verre intérieure, nouveau bras de renfort, deux types de fixation au mur, le tout pour une douche cousue sur mesure pour le client.

Technical and aesthetic reach a new equilibrium thanks to Azure, the new dimension of Inda shower space. A rich range of frameless pivot doors, with glass thickness 8mm and possible customization according to different proposals for handles and hinges, in a perfect coordination with furniture and accessories by Inda. Hinges glued by UV technique, inner glass wire, new support bar, two wall fixing techniques: everything is thought for a shower perfectly "tailored" to the customer.









Angolare
Accès d'angle
Corner

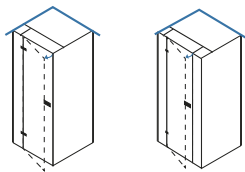

H200

8mm



Nicchia
Niche
Niche

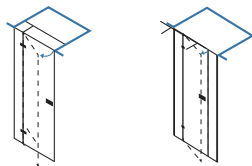

H200

8mm



Telaio
Profilé
Frame



AN
Tipo cromato anodizzato naturale lucido
Type chromé anodisé naturel brillant
Natural polished anodized chrome type

Vetro
Verre
Glass



01
Trasparente
Transparent
Transparent



14
Grigio
Gris
Grey





Hinge

Le cerniere garantiscono un movimento agevolato di apertura e chiusura delle ante.

Ouverture totale des portes aussi bien à l'intérieur que à l'extérieur.

Hinges guarantee a smooth door opening and closing movement.



Magnetic closure

Assicura la massima tenuta all'acqua.

Assure une excellente étanchéité.

It ensures the maximum water resistance.



Reinforcement brackets

Incluse nell'imballaggio. Le staffe sono necessarie per la stabilità degli elementi fissi.

Inclus dans l'emballage. L'utilisation des bras de renfort est nécessaire pour la fixation murale des éléments fixes.

Included in the package. The brackets are necessary for the stability of the fixed elements.

Maniglia
Poignée
Handle



STANDARD

Cromata
Chromé
Chrome-plated



OPTIONAL

Cromata
Chromé
Chrome-plated



OPTIONAL

Cromata
Chromé
Chrome-plated



OPTIONAL

Cromata
Chromé
Chrome-plated



OPTIONAL

Specchio
Miroir
Mirror



OPTIONAL

Vetro
Verre
Glass



OPTIONAL

HPL

Cerniera
Charnière
Hinge



STANDARD

Cromata
Chromé
Chrome-plated



OPTIONAL

Specchio
Miroir
Mirror



OPTIONAL

Vetro
Verre
Glass



OPTIONAL

HPL

Specchi
Miroir
Mirror



S300
Mirror



S301
Fumé



S302
Bronze

Colori vetro
Verre couleurs
Glass colours



TP521 E
Nero



TP523 E
Grafite



TP520 E
Creta



TP534 E
Avana



TP519 E
Cemento

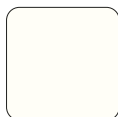

TP500 E
Bianco



TP503 E
Terra di luna



TP532 E
Bruno

HPL

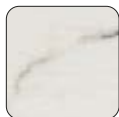

TP182
Calacatta



TP176
Malta



TP177
Porfido



TP179
Pietra chiara



TP78
Pietra scura



TP175
Cemento scuro



TP181
Texas



TP180
Lava



TP174
Yard



TP183
Oregon

PRAIA DESIGN

Great harmony.

Le pareti doccia rappresentano per Inda un elemento significativo legato ai nuovi modi dell'abitare. Un tema che Inda ha interpretato attraverso una matrice progettuale che ha saputo mediare design e tecnologia, ricerca e funzionalità.

Praia Design: nata per ambienti bagno pensati come veri e propri spazi di vita dove ritrovare armonia, benessere e qualità rispecchiando abitudini contemporanee.

La paroi de douche représente pour Inda un élément significatif lié aux nouveaux modes de l'habitat. Un thème que Inda a développé à travers une matrice de projection qui a su mélanger design et technologie, recherche et fonctionnalité.

Praia Design: née pour des salles de bains pensées comme de vrais espaces de vie, où retrouver harmonie, bien-être et qualité représentant habitudes contemporaines.

For Inda, the shower enclosure represents an important element connected with modern day living habits. A theme that Inda has developed through a program that has been able to combine design and technology, research and functionality. Praia design: born for bathroom environments thought as functional spaces in which find harmony, wellness and quality, reflecting contemporary habits.











Installazione a muro con telaio o cerniera,
a seconda del vostro gusto estetico.
Un'ampia gamma di configurazioni
enfattizzate dalla doppia valenza stilistica.

Installation murale avec cadre ou
charnière, selon votre goût esthétique. Une
large gamme de configurations soulignée
par la double valeur stylistique.

Wall installation with frame or hinge,
according to your aesthetic taste. A wide
range of configurations underlined by the
double stylistic value.

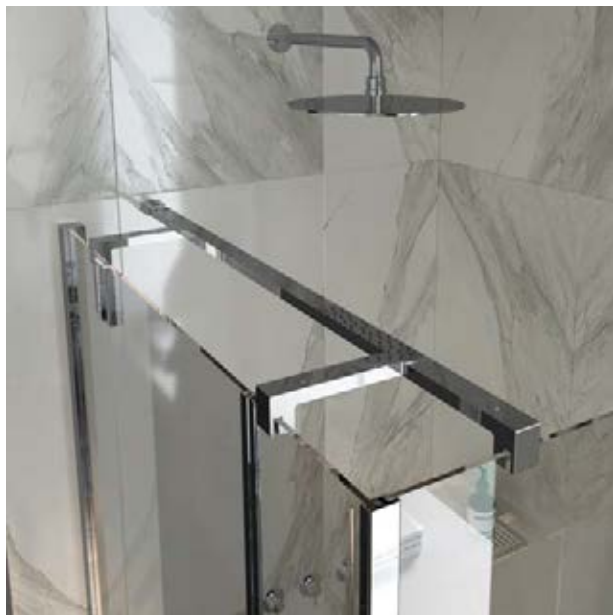









Angolare
Accès d'angle
Corner

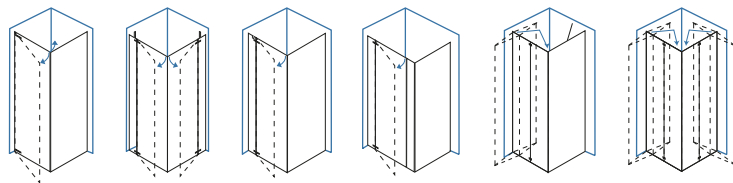

H195

6mm



Nicchia
Niche
Niche

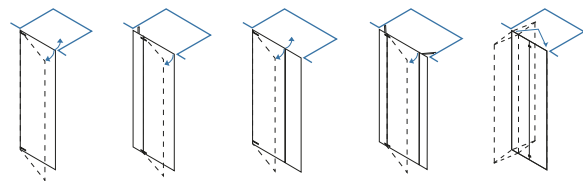

H195

6mm



Telaio
Profilé
Frame



AN
Tipo cromato anodizzato naturale lucido
Type chromé anodisé naturel brillant
Natural polished anodized chrome type

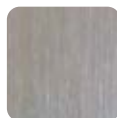

AC
Nickel spazzolato
Nickel brossé
Brushed nickel



WM
Bianco opaco
Blanc mat
White mat



BM
Nero opaco
Noir mat
Black mat

Vetro
Verre
Glass



01
Trasparente
Transparent
Transparent



14
Grigio
Gris
Grey



80
Ice

Maniglia
Poignée
Handle



Cromato
Chromé
Chrome type

Finitura maniglia in abbinamento alla
finitura telaio.

Finition de la poignée en combinaison
avec la finition du cadre.

Finish of the handle in combination
with the finish of the frame.



Nickel spazzolato
Nickel brossé
Brushed nickel



Nero opaco
Noir mat
Black mat



Bianco opaco
Blanc mat
White mat

Qualità del prodotto
Qualité du produit
Product quality



Wallmounting

Con profili in alluminio estensibili.

Avec profilés en aluminium extensibles.

With extensible aluminium profiles.

(2,5 cm)



Wall-glass hinge and glass-glass hinge

Finitura cromata, apertura dell'anta
di 180°.

Finition chromée, ouverture de la porte
à 180°.

Chromed-plated brass, door opening
180°.



Magnetic closure

Assicura la massima tenuta all'acqua.

Adoptée pour tous les articles, assure la
maximale étanchéité.

Included in all articles, ensures maxi-
mum water resistance.

CLAIRE DESIGN

Elegance and personality.

I dettagli, le finiture di qualità e l'incredibile luminosità delle pareti doccia Claire Design conferiscono una immediata sensazione di eleganza e personalità all'ambiente bagno.

Progettata con massima funzionalità e adattabilità, la serie offre infinite soluzioni compositive tutte con porta a battente per garantire comfort, armonia e raffinatezza.

Les détails, les finitions de qualité et l'incroyable luminosité des parois de douche Claire Design confèrent une immédiate sensation d'élégance et personnalité à la salle de bains. Étudiée pour une fonctionnalité et une adaptabilité totale, la série offre beaucoup de solutions toutes avec des portes battantes pour garantir confort, harmonie et élégance.

Details, qualitative finishes and the incredible brightness of Claire Design shower enclosures confer an immediate elegance and personality sensation to the bathroom. Designed for the highest functionality and adaptability, this product range offers infinite pivot door layout solutions, to ensure comfort, balance and sophistication.



























90_CLAIRE DESIGN



Angolare
Accès d'angle
Corner

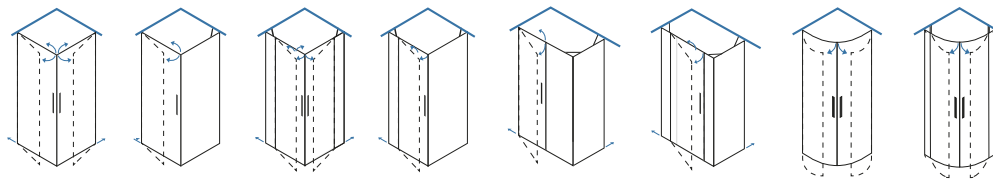

H195

6mm



Nicchia
Niche
Niche

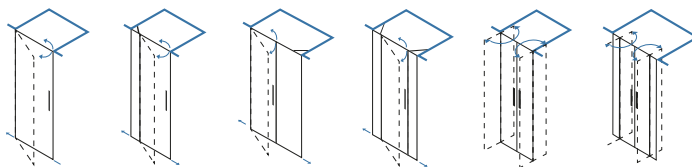

H195

6mm



Telaio
Profilé
Frame



TT
Tito titanio anodizzato naturale lucido
Type titanium anodisé naturel brillant
Natural polished anodised titanium type



AC
Nickel spazzolato
Nickel brossé
Brushed nickel



BM
Nero opaco
Noir mat
Black mat

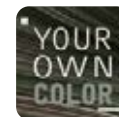

YOUR OWN COLOR
> page 6

Vetro
Verre
Glass



01
Trasparente
Transparent
Transparent



57
Serigrafato
Sérigraphie
Silk screen printed

Maniglia
Poignée
Handle



Cromato
Chromé
Chrome type

Finitura maniglia in abbinamento alla
finitura telaio.

Finition de la poignée en combinaison
avec la finition du cadre.

Finish of the handle in combination with
the finish of the frame.



Nickel spazzolato
Nickel brossé
Brushed nickel



Nero opaco
Noir mat
Black mat



YOUR OWN COLOR
> page 6

Qualità del prodotto
Qualité du produit
Product quality



Upper glass thread

Installazione in vetro in linea con il
telaio per garantire un'estetica lineare.

Installation de verre conformément à
l'encadrement pour une esthétique
linéaire.

Glass installation in line with the frame
to ensure a linear aesthetics.



Seal

Il Sistema Cam solleva l'anta per
facilitare il contatto con il bordo del
piatto doccia, evitando la fuori uscita
dell'acqua.

Le joint inférieur couplé au système
d'articulation à Came pour le
soulèvement du panneau facilite le
contact avec le bord du receveur de
douche évitant les fuites d'eau.

The Cam system lifts the door
facilitating contact with the edge of the
shower tray for a water tight seal.



Extensibility
Estensibilità 2 cm.

Extensibilité 2 cm.

Extensibility 2 cm.

AIR

Impeccable design.

Le pareti doccia: sempre più belle e curate, sempre più presenti nelle case, in ambienti bagno che sono diventati veri e propri spazi di vita. A questi, Inda dedica tutte le attenzioni ed un'importante forza produttiva. Il risultato è una gamma di soluzioni in cui si sposano la leggerezza formale e il design impeccabile uniti alla tipologia dei binari e all'altezza di 200 cm per i vetri.

Les parois de douche: toujours plus belles et soignées, toujours plus présentes dans les habitations, dans des salles de bains qui sont devenues de véritables espaces de vie. À cela, Inda dédie toutes les attentions et une importante force productive. Le résultat est une gamme de solutions qui allie la légèreté de la forme au design impeccable uni au rail et à la hauteur 200 cm pour les verres.

The shower enclosures: better looking and smarter, an increasing presence in the home, in the bathroom which has become a focal living area. To these, Inda focuses all its attention and considerable productive force. The result is a range of solutions where formal lightness and impeccable design get married, combined with the type of binaries and a glass height of 200 cm.









Angolare
Accès d'angle
Corner

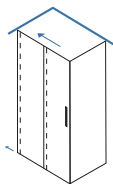

H200

8mm



Telaio
Profilé
Frame



AN
Tipo cromato anodizzato naturale lucido
Type chromé anodisé naturel brillant
Natural polished anodized chrome type

Vetro
Verre
Glass



01
Trasparente
Transparent
Transparent



14
Grigio
Gris
Grey

Maniglia
Poignée
Handle



Cromata.
Chromé.
Chrome-plated.

Nicchia
Niche
Niche

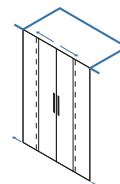
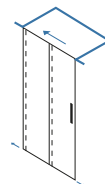

H200

8mm





Detachable doors

Un semplice gesto per facilitare la pulizia delle ante.

Un simple geste pour faciliter le nettoyage des portes.

A simple operation to facilitate cleaning.



Wall standing profile

Con profili in alluminio estensibili (2cm).

Avec pinces murales non extensibles (2 cm).

With extensible aluminium profiles (2cm).



Internal glass support

Caratteristica per cui tutta la componentistica di supporto alle lastre in cristallo, è compresa nello spessore del vetro. Le cabine doccia con questa proprietà sono particolarmente facili da pulire, in quanto la superficie interna del vetro non subisce alterazioni di spessore.

Caractéristique qui consiste à contenir tout le système de fixation du panneau en verre dans son épaisseur. Les parois de douche bénéficiant de cette particularité sont très faciles à nettoyer car la surface interne du panneau en verre ne présente aucune irrégularité d'épaisseur.

This support is within the thickness of the glass itself. Shower stalls with this feature are particularly easy to clean, as the internal surface of the glass is not subject to changes in thickness.



Soft closing

I componenti e i sistemi Soft Close rendono possibile un'apertura e una chiusura dolci e silenziose delle porte scorrevoli, grazie ad un meccanismo completamente invisibile.

Les composants et les systèmes Soft Close rendent possible une ouverture et une fermeture douces et silencieuses des panneaux coulissants grâce à un mécanisme totalement invisible.

Soft Close components and systems make it possible to open and close sliding doors gently and silently, thanks to a completely invisible mechanism.

DESIGN BY STUDIO INDA

KLAR

Fashionable shapes.

Inda presenta Nuova KLAR.

Le tendenze del mercato trovano oggi espressione in un progetto completamente nuovo, caratterizzato da design e styling distintivo, forme decisamente squadrate e spigolose, dimensioni molto ampie, altezza cm. 200, particolari curati nel dettaglio; le soluzioni realizzate sono dedicate ad un pubblico molto esigente ed allo stesso tempo aperto ai cambiamenti e alle novità.

Inda présente la nouvelle Klar.

Les tendances du marché trouvent leur expression dans un projet complètement nouveau caractérisé par un design et style bien distinct, formes carrées, dimensions très amples, hauteur 200 cm, détails soignés; les solutions réalisées sont dédiées à un public très exigeant mais ouvert au changement et aux nouveautés.

New Klar slows down your time!

Inda presents new Klar.

Market tendencies are expressed today by a brand new project, characterized by design and defined styling, squared and sharp shapes, very large dimensions, 200 cm height, very refined details; these solutions are dedicated to a public that is very demanding and at the same time open to change and news.







102_KLAR

Angolare
Accès d'angle
Corner

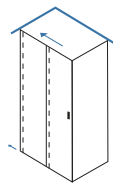

Nicchia
Niche
Niche

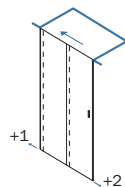

Telaio
Profilé
Frame



AN
Tipo cromato anodizzato naturale lucido
Type chromé anodisé naturel brillant
Natural polished anodized chrome type



BM
Nero opaco
Noir mat
Black mat

Vetro
Verre
Glass

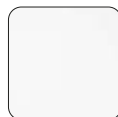

01
Trasparente
Transparent
Transparent



90
Specchio
Miroir
Mirror



STANDARD

Cromata
Chromé
Chrome-plated

Finitura maniglia in abbinamento alla
finitura telaio.

Finition de la poignée en combinaison
avec la finition du cadre.

Finish of the handle in combination with
the finish of the frame.



STANDARD

Nero opaco
Noir mat
Black mat



OPTIONAL

Cromata
Chromé
Chrome-plated



Nero opaco
Noir mat
Black mat



OPTIONAL

Cromata
Chromé
Chrome-plated



Nero opaco
Noir mat
Black mat



OPTIONAL

Vetro temprato trasparente con
supporti inox lucidi. Incollo UV. Maniglia
opzionale.

Verre trempé transparent avec supports
en acier inoxydable poli. Collage UV.
Poignée en option.

Clear tempered glass with polished
stainless steel brackets. UV bonding.
Optional handle.



Soft closing

I componenti e il sistema "Soft closing" consentono di aprire e chiudere le porte scorrevoli dolcemente e silenziosamente, grazie ad un meccanismo completamente invisibile.

Les composants et les systèmes Soft Close rendent possible une ouverture et une fermeture douces et silencieuses des panneaux coulissants grâce à un mécanisme totalement invisible.

Soft Close components and systems make it possible to open and close sliding doors gently and silently, thanks to a completely invisible mechanism.



Internal glass support

Caratteristica per cui tutta la componentistica di supporto alle lastre in cristallo, è compresa nello spessore del vetro. Le cabine doccia con questa proprietà sono particolarmente facili da pulire, in quanto la superficie interna del vetro non subisce alterazioni di spessore.

Caractéristique qui consiste à contenir tout le système de fixation du panneau en verre dans son épaisseur. Les parois de douche bénéficiant de cette particularité sont très faciles à nettoyer car la surface interne du panneau en verre ne présente aucune irrégularité d'épaisseur.

This support is within the thickness of the glass itself. Shower stalls with this feature are particularly easy to clean, as the internal surface of the glass is not subject to changes in thickness.



Detachable doors

Un semplice gesto per facilitare la pulizia delle ante.

Un simple geste pour faciliter le nettoyage des portes.

A simple operation to facilitate cleaning.



Wall standing profile

Con profili in alluminio estensibili (2cm).

Avec pinces murales non extensibles (2 cm).

With extensible aluminium profiles (2cm).

DESIGN BY STUDIO INDA

TRENDY DESIGN

A new style for your bathroom.

Trendy Design: una serie nel segno della continua ricerca estetica, esplorando gli stili e le ispirazioni più diverse. Porte scorrevoli curate nei dettagli e con un'eccezionale varietà di finiture vetri, interpretano soluzioni perfettamente calate nell'attualità che vanno verso una sempre maggiore individualità.

Trendy Design: une collection sous le signe de la recherche esthétique continue, explore les styles les plus variés. Portes coulissantes aux détails soignés et une variété exceptionnelle de finitions de verre interprètent des solutions parfaitement adaptées à l'actualité qui vont vers une plus grande individualité.

Trendy Design: a series in the sign of continuous esthetic research, exploring the many different styles and inspirations. Sliding doors with attention to detail and exceptional variety of glasses finishes interpreting perfect solution decreased in the actuality which go to always in greater individuality.

















Angolare
Accès d'angle
Corner

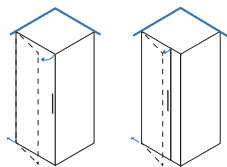

H195

6mm



Nicchia
Niche
Niche

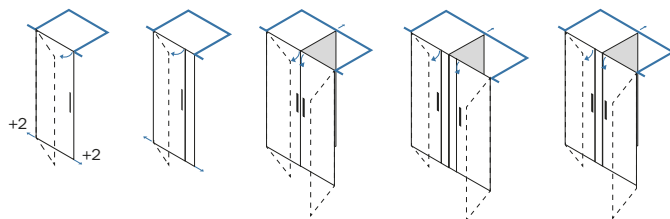

H195

6mm



Telaio
Profilé
Frame



AN
Tipo cromato anodizzato naturale lucido
Type chromé anodisé naturel brillant
Natural polished anodized chrome type

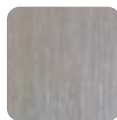

AC
Nickel spazzolato
Nickel brossé
Brushed nickel



WM
Bianco opaco
Blanc mat
White mat



BM
Nero opaco
Noir mat
Black mat

Vetro
Verre
Glass



01
Trasparente
Transparent
Transparent



14
Grigio
Gris
Grey



80
Ice



90
Specchio
Mirror
Mirror

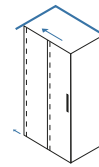
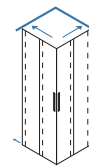

H195

6mm

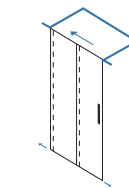

H195

6mm



Maniglia
Poignée
Handle



STANDARD

Finitura maniglia in abbinamento
alla finitura telaio.

Finition de la poignée en combinaison
avec la finition du cadre.

Finish of the handle in combination with
the finish of the frame.



OPTIONAL

Cromata
Chromé
Chrome-plated



OPTIONAL

Cromata
Chromé
Chrome-plated



OPTIONAL

Cromata
Chromé
Chrome-plated

Qualità del prodotto
Qualité du produit
Product quality



Chrome seal

Profilo con taglio a 45° e chiusura
magnetica delle ante.

Profils avec coupe à 45° et fermeture
magnétique des portes.

Profiles with 45° cut and doors with
magnetic closure.



Detachable doors

Una semplice azione per facilitare la
pulizia.

Un simple geste pour faciliter le
nettoyage des portes.

A simple operation to facilitate cleaning.

SOPRAVASCA

Nati con l'obiettivo di trovare nuove soluzioni e nuove opportunità di utilizzo per l'ambiente bagno, i sopravasca completano la gamma delle pareti doccia di Inda. Eleganti pannelli in vetro innovativi ripiegabili a muro e fissi, permettono di fare una doccia quando si è di fretta e consentono di preparare un rilassante bagno quando si necessita di calma e tranquillità.

Nés avec l'objectif de trouver de nouvelles solutions et de nouvelles opportunités pour la salle de bains, les écrans de baignoire complètent la gamme des parois de douche Inda. Élégants panneaux en verre innovants, repliables sur le mur et fixes permettant de prendre une douche quand on est pressé et permettent également de prendre un bain relaxant quand on a besoin de calme et de tranquillité.

Born with the objective to find new solutions and new opportunities of using for bathrooms environment, bathscreens complete the shower wall range of Inda. Elegant and innovative glass panels folding and fixed to wall that allow to take a shower when you are hurry and permit to prepare a relaxed bath when you need calm and peace of mind.













Soprasasca
Ecrans de baignoire
Bathscreens

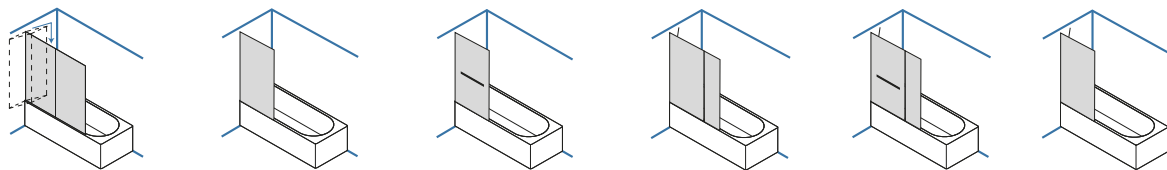

H140

6mm



Soprasasca
Ecrans de baignoire
Bathscreens

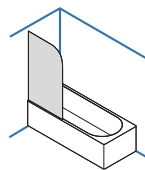

H140

6mm



Soprasasca
Ecrans de baignoire
Bathscreens

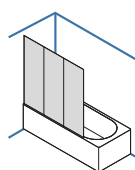

H135

3mm



Telaio
Profilé
Frame



AN
Tipo cromato anodizzato naturale lucido
Type chromé anodisé naturel brillant
Natural polished anodized chrome type



AA
Silver anodizzato naturale opaco
Silver anodisé naturel mat
Natural matt anodized silver



AC
Nickel spazzolato
Nickel brossé
Brushed nickel

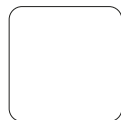

WZ
Bianco verniciato RAL 9010
White painted RAL 9010
Blanc verni RAL 9010
Blanco pintado RAL 9010

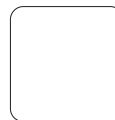

WM
Bianco opaco
Blanc mat
White mat



BM
Nero opaco
Noir mat
Black mat

Vetro
Verre
Glass

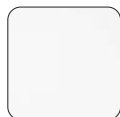

01
Trasparente
Transparent
Transparent



80
Icè

Qualità del prodotto
Qualité du produit
Product quality



La rotazione verso l'esterno dei pannelli
semplifica la pulizia.

La rotation des panneaux aussi vers
l'extérieur facilite les opérations de
nettoyage.

The outward rotation of the panels
simplifies cleaning.



Il movimento di apertura e chiusura
delle ante è agevolato tramite cerniere
dotate di sistema di sollevamento
Camme.

Ouverture grâce à une articulation à
Came intégrée. Ouverture totale des
portes aussi bien à l'intérieure que à
l'extérieure.

Hinges with "Camme" lifting system
guarantees a smooth door opening and
closing movement.

FINISHES

La creatività trova libera espressione in un sistema sartoriale dei nostri spazi, dei nostri gusti e della nostra identità. Ampia gamma di finiture per la personalizzazione di un ambiente esclusivo.

La créativité trouve liberté d'expression dans un système qui peut réaliser sur mesure nos espaces, nos goûts et notre identité. Une grande variété de finitions pour la personnalisation d'un espace unique.

Creativity finds its expression in a system always tailored to one's spaces, tastes and identity. Wide range of finishes for customizing an exclusive environment.



Freedom of being

Inda propone un'unica soluzione cromatica per tutta la stanza da bagno, con 15 colori opachi selezionati per:

- le pareti doccia WALK IN e CLAIRE DESIGN
- gli accessori LEA, GEALUNA, MY LOVE e MY SECRET
- specchi PIRANO, MAGGIORE, TENNO, ZARA e SPALATO

da abbinare alle stesse finiture mobili e piani top, ai lavabi integrati Giotto e ai lavabi in appoggio in mineralguss.

Inda propose une solution de couleur unique pour toute la salle de bain, avec 15 couleurs opaques sélectionnées pour :

- les parois de douche WALK IN et CLAIRE DESIGN
- les accessoires LEA, GEALUNA, MY LOVE et MY SECRET
- miroirs PIRANO, MAGGIORE, TENNO, ZARA et SPALATO

à combiner avec les mêmes finitions des meubles, plans top des meubles, avec les lavabos Giotto intégré et aux lavabos en mineralguss.

Inda suggests an entire colour solution for your bathroom, with 15 selected matt shades for:

- WALK IN and CLAIRE DESIGN shower enclosures
- LEA, GEALUNA, MY LOVE and MY SECRET accessories
- PIRANO, MAGGIORE, TENNO, ZARA and SPALATO mirrors

to be combined with the same finishes of cabinets and worktops, Giotto integrated washbasins and tabletop washbasins in mineral marble.



GF
Laccato opaco Grafite
Mat lacquered Grafite



TN
Laccato opaco Titanio
Mat lacquered Titanio



BD
Laccato opaco Blu denim
Mat lacquered Blu denim



AV
Laccato opaco Avio
Mat lacquered Avio



PT
Laccato opaco Platino
Mat lacquered Platino



CX
Laccato opaco Creta
Mat lacquered Creta



ST
Laccato opaco Seta
Mat lacquered Seta



MP
Laccato opaco Perla
Mat lacquered Perla

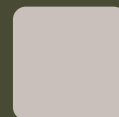

AX
Laccato opaco Avorio
Mat lacquered Avorio



VV
Laccato opaco Verde salvia
Mat lacquered Verde salvia



VF
Laccato opaco Verde felce
Mat lacquered Verde felce

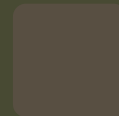

BN
Laccato opaco Bruno
Mat lacquered Bruno



VN
Laccato opaco Avana
Mat lacquered Avana



VS
Laccato opaco Visone
Mat lacquered Visone



TL
Laccato opaco Terra di Luna
Mat lacquered Terra di Luna



AN
Tipo cromato anodizzato naturale lucido
Type chromé anodisé naturel brillant
Natural polished anodized chrome type



NS
Acciaio inox spazzolato
Acier inoxydable brossé
Brushed stainless steel

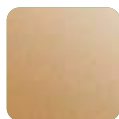

OR
Oro rosato lucido
Doré rosé brillant
Glossy rose-coloured gilded



AC
Nickel spazzolato
Nickel brossé
Brushed nickel



AA
Silver anodizzato naturale opaco
Silver anodisé naturel mat
Natural matt anodized silver



BZ
Bronzo
Bronze
Bronzed



TT
Tipo titanio anodizzato naturale lucido
Type titanium anodisé naturel brillant
Natural polished anodised titanium type

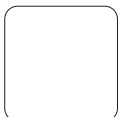

WM
Bianco opaco
Blanc mat
White mat



BM
Nero opaco
Noir mat
Black mat

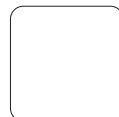

WZ
Bianco verniciato RAL 9010
White painted RAL 9010
Blanc verni RAL 9010
Blanco pintado RAL 9010



YOUR OWN COLOR
> page 6



01
Trasparente
Transparent
Transparent



14
Grigio
Gris
Grey



80
Ice



90
Specchio
Miroir
Mirror



41
Ice Grigio
Ice Gris
Ice Grey



57
Serigrafato
Sérigraphie
Silk screen printed

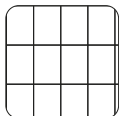

DG
Verrière

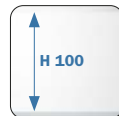

73
Trasparente con fascia serigrafata
Transparent avec bande sérigraphiée
Transparent with silk screen printed band

SYMBOL KEY



Garanzia
Garantie
Warranty



Spessore del vetro
Épaisseur verre
Glass thickness



Altezza
Hauteur
Height



Installazione reversibile
Installation réversible
Reversible installation



Installazione non reversibile
Installation non réversible
Not reversible installation



Anta sganciabile
Porte décrochable
Detachable door



Soft-closing



Componenti a filo vetro
Composant à fleur du verre
Component flush with glass



Tecnologia incollaggio UV
Technologie de collage UV
UV bonding technology



Trattamento anticalcare
Traitement pour la protection du verre
Anti limescale treatment

Inda si riserva, a proprio insindacabile giudizio, di apportare modifiche anche senza preavviso, allo scopo di migliorare la produzione.

Inda se réserve le droit, à tout moment et à son jugement sans appel, d'apporter des modifications sans préavis, afin d'améliorer la production.

Inda reserves the right to modify the products without advance notice to improve production.

INDA SpA

Registered Office
Operational Headquarters
Via dell'Industria, 41
I-24040 Pagazzano (BG)

Bathroom Furniture
Via Postumia Ovest, 72
I-31048 Olmi di San Biagio di Callalta (TV)

www.inda.net
info@inda.net

PIva: IT03868760962
Registro Imprese di Bergamo: 03868760962
Numero REA: BG – 386581
Capitale Sociale: Euro 4.000.000,00 i.v.



