

NOVAMOBILI



Details
collection

NOVAMOBILI

Details
collection

Indice
Contents

Tavoli
Tables
p. 06

Filo
p. 8

Hanami
p. 16

Level
p. 24

Rea
p. 32

Stretch
p. 40

Sunny
p. 48

Torii
p. 56

Sedute
Seating
p. 64

Agel
p. 66

Candy
p. 72

Ellen
p. 78

Natt
p. 84

Navy, Navy Tub
p. 90

Rose
p. 98

Time
p. 106

Twist
sedia, sgabello,
sedia lounge / chair,
stool, lounge chair
p. 112

Yoko
p. 120

Church
panca / bench
p. 124

Dora
panca / bench
p. 128

Madie
Sideboards
p. 132

Bay
p. 134

Belt
p. 140

Cleo
p. 150

Fjord
p. 156

Float
p. 164

Reverse
p. 170

Shadows
p. 176

Stripe
p. 182

Tavolini
Occasional tables
p. 190

Alice
p. 192

Allout
p. 196

Balance
p. 200

Circle
p. 204

Cliff
p. 208

Fly
p. 212

Globe
p. 218

Kin
p. 224

Orbis
p. 230

Seven
p. 234

Shadows
p. 238

Team
p. 242

Trio
p. 246

Accessori
Accessories
p. 250

Astrid
specchio / mirror
p. 252

Deep
specchio / mirror
p. 256

Flow
specchio / mirror
p. 260

Odette
specchio / mirror
p. 264

Riga
mensola / shelf
p. 268

Cube
panche e boiserie /
benches and wall panelling
p. 276

Desk
scrittoio / desk
p. 282

Knot
scrittoio / desk
p. 288

Ninfea
scrittoio / desk
p. 294

Shy
paravento / screen
p. 300

Jupiter
servomuto / valet stand
p. 306

Freebook
libreria / bookcase
p. 312

Finiture e materiali
Finishes and materials
p. 316

Indice prodotti
Product index
p. 323

Tavoli
Tables



Filo

— Design by Novamobili studio



Un design minimale e una struttura leggera contraddistinguono il tavolo Filo, disponibile in versione quadrata o rettangolare. Le linee essenziali e le numerose possibilità di personalizzazione ne fanno un tavolo versatile, che si adatta ai più diversi contesti. Il tavolo è disponibile in tutti i colori laccati opachi, ossidati e metal. Per un effetto più prezioso, al piano si può applicare un top in light stone o, nella versione rettangolare, anche nelle finiture argilla, noce e olmo termotrattato.

Minimal design and a light frame give the Filo table – available in a square and rectangular version – its distinctive look. Pared-back lines and a wealth of custom options make this a versatile table that works well in all manner of settings. The table comes in any of the matt, oxidized and metal lacquered colour options. For an even more luxe feel, a light stone top can be applied, while the rectangular version also comes in the clay, noce and olmo termotrattato finishes.





^{IT} Tavolo **Filo** quadrato con struttura in laccato opaco nero grafite e piano sp. 0,6 cm in light stone nero, sedie **Rose** con struttura in finitura rovere carbone e seduta con rivestimento Eva 11. Madia composta da basi **Box 18** in finitura rovere carbone, vassoio credenza e base **Box 18** in laccato opaco blu notte.

^{EN} Square **Filo** table with nero grafite matt lacquered frame and 0,6cm-thick nero light stone top, **Rose** chairs with frame in rovere carbone finish and seat upholstered in Eva 11. Sideboard comprising **Box 18** base units in rovere carbone finish, sideboard tray and **Box 18** base unit in blu notte matt lacquered finish.



^{IT} Tavolo *Filo* rettangolare con struttura in laccato opaco quarzo e piano sp. 1,2 cm in finitura noce, sedia *Navy Tub* con struttura in finitura rovere terra e seduta con rivestimento Eva 20. Libreria *Wall 12* in laccato opaco ginepro. Pouf *Loto* con rivestimento Eva 20.

^{EN} Rectangular *Filo* table with quarzo matt lacquered frame and 1,2cm-thick top in noce finish, *Navy Tub* chair with frame in rovere terra finish and seat upholstered in Eva 20. *Wall 12* bookcase in ginepro matt lacquered finish. *Loto* ottoman upholstered in Eva 20.



^{IT} Tavolo **Filo** con struttura in laccato opaco sabbia e piano sp. 0,6 cm in finitura light stone breccia medicea, sedie **Natt** con struttura in laccato opaco ginepro e seduta in tessuto Laila 54. Pouf **Log** in pelle extra Ares 13.

^{EN} **Filo** table with sabbia matt lacquered frame and 0,6cm-thick top in breccia medicea light stone finish, **Natt** chairs with frame in ginepro matt lacquered finish and seat in Laila 54 fabric. Log ottoman in Ares 13 extra leather.

TECHNICAL DATA

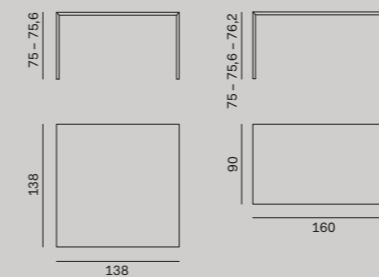

CLOSE-UP

- 1 Variante del tavolo L 160 cm con struttura in laccato ossidato brunito e piano sp. 1,2 cm in finitura argilla lapis. / 160cm-long table version with oxidized bronze lacquered frame and 1,2cm-thick top in lapis clay finish.
- 2 Variante del tavolo L 160 cm con struttura in laccato ossidato bronzo e piano sp. 1,2 cm in finitura olmo termotrattato. / 160cm-long table version with oxidized light bronze lacquered frame and 1,2cm-thick top in olmo termotrattato finish.
- 3 Variante del tavolo in laccato opaco foresta. / Table version in foresta matt lacquered finish.



1



2



3

Hanami

— Design by Matteo Zorzenoni



Linee fluide e attenzione ai dettagli caratterizzano il tavolo Hanami. Le gambe inclinate e rastremate gli conferiscono dinamismo e leggerezza: un lavoro di ebanisteria che ne rivela l'alta qualità produttiva. Il piano è disponibile in marmo e pietra lavica, oppure nelle finiture noce canaletto, rovere chiaro, rovere carbone e in tutti i colori laccati opachi. Le gambe in finitura noce canaletto, rovere chiaro e rovere carbone.

Flowing lines and attention to detail are the distinguishing features of the Hanami table. The angled, tapering legs produce a light, dynamic look: cabinet-making expertise has been applied to produce a piece of the highest quality. The top is available in marble and lava stone, or in the noce canaletto, rovere chiaro and rovere carbone finishes and any of the matt lacquered colour options. Legs can be in the noce canaletto, rovere chiaro or rovere carbone finish.





^{IT} Tavolo **Hanami** con gambe in finitura noce canaletto e piano in marmo grigio Oriente opaco, sedie **Rose** con struttura in finitura noce canaletto, seduta e schienale imbottiti in tessuto Egle 18. Libreria **Pontile** con montanti in alluminio brunito, ripiani e listelli frontali in laccato ossidato brunito. Madia composta da basi **Box 18** in laccato opaco foresta e contenitori **Outline** con scocca e schiena in finitura noce e telaio in laccato opaco foresta, in appoggio su panca sp. 5 cm nella stessa finitura.

^{EN} **Hanami** table with legs in noce canaletto finish and matt grigio Oriente marble top, **Rose** chairs with frame in noce canaletto finish, padded seat and back in Egle 18 fabric. **Pontile** bookcase with bronze-finish aluminium uprights, shelves and front strips in oxidized bronze lacquered finish. Sideboard comprising **Box 18** base units in foresta matt lacquered finish and **Outline** storage units with carcass and back panel in noce finish with foresta matt lacquered frame, sitting on 5cm-thick bench in the same finish.

IT Tavolo Hanami in finitura rovere chiaro e sedie Twist con struttura nella stessa finitura, seduta e schienale in tessuto Gaia 05. Contenitori sospesi Outline in laccato opaco laguna. Madia sospesa composta da basi Box 18 in finitura argilla pomice. Poltrona Origin in tessuto Calima 05 e 08.

EN Hanami table in rovere chiaro finish and Twist chairs with frame in the same finish, seat and back in Gaia 05 fabric. Outline wall units in laguna matt lacquered finish. Wall-mounted sideboard comprising Box 18 base units in pomice clay finish. Origin armchair in Calima 05 and 08 fabrics.



TECHNICAL DATA

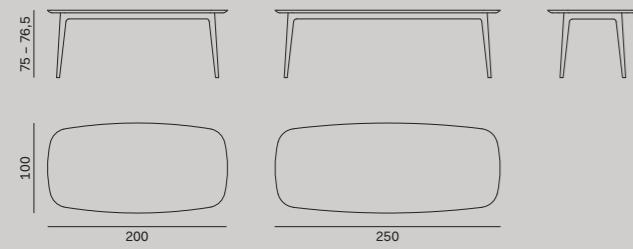

CLOSE-UP

— 1
Variante del tavolo con gambe e piano in finitura rovere carbone. / Table version with legs and top in rovere carbone finish.

— 2
Variante del tavolo con gambe in finitura rovere chiaro e piano in marmo bianco di Carrara opaco. / Table version with legs in rovere chiaro finish and top in matt bianco Carrara marble.

— 3
Variante del tavolo con gambe in finitura noce canaletto e piano in laccato opaco fango. / Table version with legs in noce canaletto finish and top in fango matt lacquered finish.



1

2

3

IT Tavolo Hanami con gambe in finitura rovere carbone e piano in laccato opaco piombo. Sedie Time in tessuto Chloé 05 e Egle 17. Pensile Box 12 in laccato opaco visone.

EN Hanami table with legs in rovere carbone finish and top in piombo matt lacquered finish. Time chairs in Chloé 05 and Egle 17 fabric. Box 12 wall unit in visone matt lacquered finish.



Level

— Design by Matteo Zorzenoni



Level è un tavolo caratterizzato dalle linee morbide della struttura, che sostiene un piano sottile dagli angoli arrotondati. È allungabile fino a due metri e mezzo, per ospitare dieci commensali. Il tavolo è disponibile in finitura rovere miele, rovere grigio e rovere terra.

Level is a table characterized by the soft lines of its frame, which supports a slim top with rounded corners. It extends up to an impressive two-and-a-half metres, seating up to ten. The table is available in the rovere miele, rovere grigio and rovere terra finishes.





IT Tavolo Level in finitura rovere miele, sedie Natt con struttura nella stessa finitura e seduta in tessuto Florence 17, pouf Log in tessuto Gaia 05. Libreria Pontile con montanti in alluminio brunito, ripiani e listelli frontali in laccato opaco piombo.

EN Level table in rovere miele finish, Natt chairs with frame in the same finish and seat in Florence 17 fabric, Log ottoman in Gaia 05 fabric. Pontile bookcase with bronze-finish aluminium uprights, shelves and front strips in piombo matt lacquered finish.



^{IT} Tavolo Level in finitura rovere terra, sedie Navy con struttura nella stessa finitura e seduta in tessuto Calima 17, pouf Log in tessuto Gaia 05. Madia Box 18 in laccato lucido ginepro e basamento Tube in laccato ossidato brunito.

^{EN} Level table in rovere terra finish, Navy chairs with frame in the same finish and seat in Calima 17 fabric, Log ottomans in Gaia 05 fabric. Box 18 sideboard in ginepro gloss lacquered finish on oxidized bronze lacquered Tube base.



TECHNICAL DATA

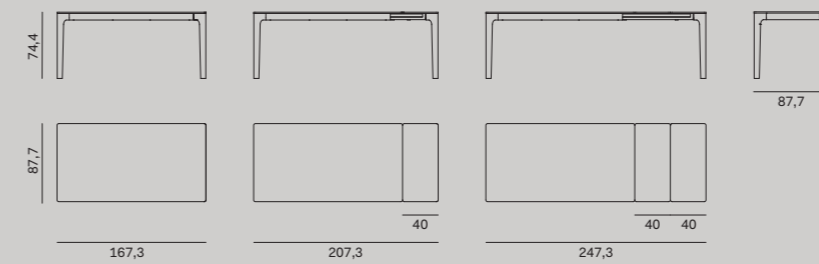

IT Tavolo Level in finitura rovere grigio. Pouf Log in tessuto Bonnie 39.

EN Level table in rovere grigio finish. Log ottoman in Bonnie 39 fabric.

CLOSE-UP

– 1 Variante del tavolo in finitura rovere miele. / Table version in rovere miele finish.

– 2 Variante del tavolo in finitura rovere terra. / Table version in rovere terra finish.



Rea

— Design by Novamobili studio



Il tavolo Rea incarna l'eleganza che si fonde con un design moderno e funzionale. Il piano riflette il perfetto equilibrio tra minimalismo ed essenzialità, offrendo un'ampia scelta di finiture: laccato opaco e ossidato, nelle finiture impiallacciate di rovere o noce canaletto, argilla e light stone. È possibile personalizzare Rea, abbinando le gambe nella stessa finitura o a contrasto scegliendo tra: finiture impiallacciate di rovere o noce canaletto.

The Rea table embodies elegance, which is merged with a modern, functional design. The top reflects the perfect balance between minimalism and a pared-back aesthetic, with an extensive range of finishes to choose from: matt and oxidized lacquered, rovere veneer or noce canaletto finishes, in addition to clay and light stone finishes. Rea can be customized by pairing the top with legs in the same finish or a contrasting finish, choosing one of the rovere veneer or noce canaletto finishes.





^{IT} Tavolo **Rea** in finitura rovere bianco, sedie **Navy Tub** con struttura in finitura rovere bianco e seduta in tessuto Sophie 06. Pouf **Loto** in tessuto Gaia 21. Madia **Belt** in laccato opaco foglia con ante **Era** in vetro trasparente e telaio in laccato opaco foglia, interni in laccato opaco foglia e basamento in laccato ossidato brunito.

^{EN} **Rea** table in rovere bianco finish, **Navy Tub** chairs with rovere bianco frame and seat in Sophie 06 fabric. **Loto** ottoman in Gaia 21 fabric. **Belt** sideboard in foglia matt lacquered finish with **Era** transparent glass doors featuring foglia matt lacquered frame, interior in foglia matt lacquered finish, and oxidized bronze lacquered base.



^{IT} Dettaglio del piano in light stone grigio alpi carnia. Nella pagina accanto, tavolo **Rea** in finitura rovere carbone e piano in light stone grigio alpi carnia, sedie **Candy** con struttura in finitura rovere carbone e seduta in tessuto Callas 40. Madia **Reverse** in finitura rovere carbone, con ante e basamento in laccato ossidato peltro.

^{EN} Detail of grigio alpi carnia light stone top. Opposite: **Rea** table in rovere carbone finish with grigio alpi carnia light stone top, **Candy** chairs with rovere carbone frame and seat in Callas 40 fabric. **Reverse** sideboard in rovere carbone finish, with oxidized pewter lacquered doors and base.



TECHNICAL DATA

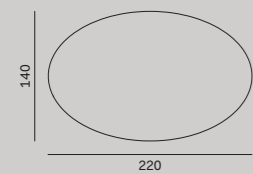
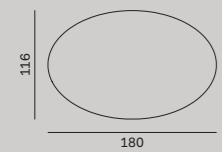

CLOSE-UP

— 1
Variante del tavolo con gambe in noce canaletto e piano in light stone emperador. / *Table version with legs in noce canaletto finish and emperador light stone top.*

— 2
Variante del tavolo L 180 cm con gambe e piano in laccato ossidato peltro. / *180cm-long table version with legs and top in oxidized pewter lacquered finish.*

— 3
Variante del tavolo L 180 cm con gambe e piano in rovere miele. / *180cm-long table version with legs and top in rovere miele finish.*



1



2



3



^{IT} Tavolo Rea in finitura rovere grigio con piano in argilla lapis. Sedie Twist con struttura in finitura rovere grigio e seduta in tessuto Egle 18. Pouf Log in tessuto Callas 37.

^{EN} Rea table in rovere grigio finish with top in lapis clay finish. Twist chairs with frame in rovere grigio finish and seat in Egle 18 fabric. Log ottoman in Callas 37 fabric.

Stretch

— Design by Zaven



Stretch è un tavolo allungabile dall'aspetto solido e contemporaneo. È costituito da elementi essenziali, combinati tra loro in modo originale: la cornice che sorregge il top accoglie anche le gambe, posizionate agli angoli per dare vita a un disegno caratterizzante. Il tavolo, in finitura rovere carbone o noce canaletto, è pensato per gli ambienti domestici e le occasioni conviviali: allungabile fino a tre metri, può ospitare dodici persone.

Stretch is a solid and contemporary looking extending table. It is the sum of pared-back elements put together in an original way: the frame supporting the top also accommodates the legs, which are set at an angle to produce a distinctive design. The table, in the rovere carbone or noce canaletto finish, has been designed for entertaining at home: it extends up to an impressive three metres, seating up to twelve people.



^{IT} Tavolo Stretch in finitura noce canaletto, sedie Rose con struttura nella stessa finitura, seduta e schienale imbottiti in tessuto Egle 18. Madia Stripe in laccato opaco piombo con top in finitura noce canaletto e basamento in laccato opaco piombo.

^{EN} Stretch table in noce canaletto finish, Rose chairs with frame in the same finish, padded seat and back in Egle 18 fabric. Stripe sideboard in piombo matt lacquered finish with top in noce canaletto finish and piombo matt lacquered base.

Tavoli
Tables



^{IT} Tavolo Stretch nella versione con 2 allunghe, in finitura rovere carbone, sedie Time in tessuto Bonnie 18, pouf Loto in tessuto Victoria 17 e con rivestimento Eva 20. Madia composta da basi Box 18 in finitura argilla pomice su basamento Tube in laccato ossidato brunito. Contenitori sospesi Outline con telaio in laccato ossidato brunito, scocca e schiena in finitura olmo termotrattato.

^{EN} Stretch table in version with 2 extension leaves, in rovere carbone finish, Time chairs in Bonnie 18 fabric, Loto ottomans in Victoria 17 fabric and upholstered in Eva 20. Sideboard comprising Box 18 base units in pomice clay finish on oxidized bronze lacquered Tube base. Outline wall units with oxidized bronze lacquered frame, carcass and back panel in olmo termotrattato finish.



TECHNICAL DATA

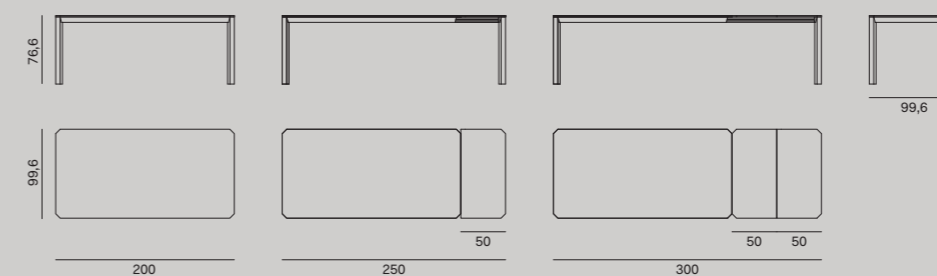

CLOSE-UP

- 1
Variante del tavolo aperto per essere allungato. / *Table version opened for extending.*
- 2
Il tavolo allungato con un'allunga. / *The table extended with a single extension leaf.*
- 3
Il tavolo allungato con due allunghie. / *The table extended with two extension leaves.*



Sunny

— Design by Zaven



Il tavolo Sunny si distingue per il suo design contemporaneo ed essenziale. Sostenuto da tre gambe metalliche dal tratto pulito e dinamico, presenta un piano circolare altamente personalizzabile. Le opzioni per il piano includono marmo, pietra lavica, noce, olmo termotrattato, laccato opaco e ossidato, impiallacciato di rovere e argilla, oltre al resistente e impermeabile light stone, un materiale ceramico. Il basamento offre una varietà di colori tra cui laccati opachi, ossidati o effetto metallico, consentendo combinazioni raffinate e preziose.

The Sunny table stands out for its contemporary, pared-back design. Sitting on three metal legs designed with clean, dynamic lines, it features a highly customizable circular top. The options for the top include marble, lava stone, noce, olmo termotrattato, matt and oxidized lacquered finishes, rovere veneer and clay, as well as light stone, a strong, impermeable ceramic material. The base comes in a variety of colours, including matt, oxidized or metal-look lacquered finishes, allowing for refined luxe colourways.



^{IT} Tavolo **Sunny** con gambe in laccato metal ottone e piano in light stone bianco, sedie **Twist** con struttura in finitura rovere terra, seduta e schienale in tessuto Sophie 05. Madia **Cleo** in finitura rovere terra con maniglia e basamento in laccato metal ottone. Pouf **Loto** in tessuto Sophie 05. Tavolino **Circle** in laccato ossidato brunito.

^{EN} **Sunny** table with legs in brass metal lacquered finish and bianco light stone top, **Twist** chairs with frame in rovere terra finish, seat and back in Sophie 05 fabric. **Cleo** sideboard in rovere terra finish with handle and base in brass metal lacquered finish. **Loto** ottoman in Sophie 05 fabric. **Circle** occasional table in oxidized bronze lacquered finish.





^{IT} Tavolo **Sunny** con gambe in laccato ossidato brunito e piano in finitura olmo termotrattato, sedie **Time** in tessuto Florence 28, pouf **Loto** in tessuto Victoria 17. Madie composte da basi **Box 18** in laccato lucido blu notte e contenitori **Tetris** in finitura rovere carbone su basamento **Double** in laccato ossidato brunito.

^{EN} **Sunny** table with oxidized bronze lacquered legs and top in olmo termotrattato finish, **Time** chairs in Florence 28 fabric, **Loto** ottoman in Victoria 17 fabric. Sideboards comprising blu notte gloss lacquered **Box 18** base units and **Tetris** storage units in rovere carbone finish on **Double** base in oxidized bronze lacquered finish.



TECHNICAL DATA

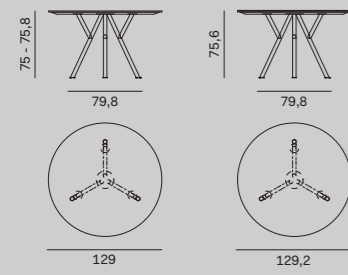

CLOSE-UP

- 1
Variante del tavolo con gambe in laccato opaco ginepro e piano in marmo verde Guatemala opaco. / *Table version with ginepro matt lacquered legs and matt verde Guatemala marble top.*
- 2
Variante del tavolo con gambe e piano in laccato opaco blu notte. / *Table version with legs and top in blu notte matt lacquered finish.*
- 3
Variante del tavolo con gambe in laccato opaco quarzo e piano in finitura argilla fumo. / *Table version with quarzo matt lacquered legs and top in fumo clay finish.*



1



2



3

^{IT} Tavolo *Sunny* con gambe in laccato opaco cotto e piano in finitura rovere carbone.

^{EN} *Sunny* table with legs in cotto matt lacquered finish and top in rovere carbone finish.



Torii

— Design by Matteo Zorzenoni



Ispirato agli antichi portali d'accesso dei templi giapponesi, il tavolo Torii è costituito da una struttura con elemento centrale a forma di T rovesciata, che si unisce morbidamente al piano. Presentato in eleganti abbinamenti materico-cromatici, il piano può essere in marmo o pietra lavica, in finitura rovere carbone o noce canaletto, o ancora in tutti i colori laccati opachi; le gambe in finitura rovere carbone e noce canaletto.

Inspired by ancient Japanese temple gateways, the Torii table comprises a frame featuring a central element in an inverted T shape that connects gently with the top. Presented in elegant material and colour combinations, its top can be in marble or lava stone, in either the rovere carbone or noce canaletto finish, or any of the matt lacquered colours, while the legs come in rovere carbone and noce canaletto finishes.





^{IT} Tavolo **Torii** in finitura rovere carbone e sedie **Navy** con struttura nella stessa finitura e seduta in tessuto **Aura 05**. **Madia** sospesa composta da basi **Box 18** in finitura rovere carbone, vassoio credenza e base **Box 18** in laccato opaco blu notte.

^{EN} **Torii** table in rovere carbone finish and **Navy** chairs with frame in the same finish and seat in **Aura 05** fabric. Wall-mounted sideboard comprising **Box 18** base units in rovere carbone finish, sideboard tray and **Box 18** base unit in blu notte matt lacquered finish.

IT Tavolo Torii con gambe in finitura noce canaletto e piano in marmo grigio Oriente opaco, sedie Time e pouf Loto con rivestimento Eva 20. Madia Float in laccato ossidato peltro con basamento in laccato ossidato brunito.

EN Torii table with legs in noce canaletto finish and matt grigio Oriente marble top, Time chairs and Loto ottoman upholstered in Eva 20. Float sideboard in oxidized pewter lacquered finish with oxidized bronze lacquered base.





^{IT} Tavolo **Torii** con gambe in finitura noce canaletto e piano in laccato opaco ginepro. Sedia **Candy** con struttura in laccato opaco ginepro e seduta in tessuto Callas 37.

^{EN} **Torii** table with legs in noce canaletto finish and top in ginepro matt lacquered finish. **Candy** chair with ginepro matt lacquered frame and seat in Callas 37 fabric.

TECHNICAL DATA

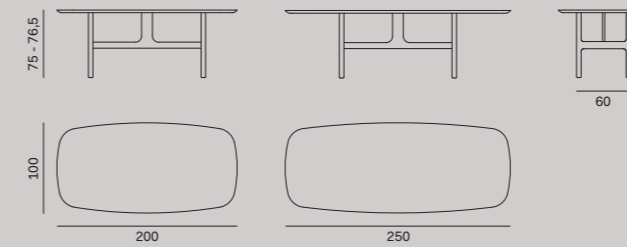

CLOSE-UP

– 1 Variante del tavolo con gambe in finitura rovere carbone e piano in pietra lavica opaca. / *Table version with legs in rovere carbone finish and matt lava stone top.*

– 2 Variante del tavolo con gambe e piano in finitura noce canaletto. / *Table version with legs and top in noce canaletto finish.*

– 3 Variante del tavolo con gambe in finitura rovere carbone e piano in laccato opaco visone. / *Table version with legs in rovere carbone finish and top in visone matt lacquered finish.*



1



2



3

Sedute
Seating



Agel

— Design by e-ggs



La sedia Agel incarna l'eleganza senza tempo dello stile nordico con un tocco moderno. Agel presenta una struttura tubolare sottile e uno schienale che si fonde armoniosamente con la seduta, creando una sensazione di fluidità nell'insieme.

The Agel chair embodies the timeless elegance of Nordic design with a modern touch. Agel features a slim tubular frame and a backrest that merges harmoniously with the seat, giving the resulting piece a flowing feel.





^{IT} Sedie **Agel** con struttura in metallo laccato ossidato brunito e in finitura rovere grigio, seduta in tessuto Mya 11. Sedia **Agel** con struttura in metallo laccato ossidato brunito e in finitura rovere grigio, seduta in tessuto Callas 11. Tavolo **Level** in finitura rovere grigio. Contenitore **Hub** in laccato opaco nero grafite.

^{EN} **Agel** chairs with frame in oxidized bronze lacquered metal and rovere grigio finishes, seat in Mya 11 fabric. **Agel** chair with frame in oxidized bronze lacquered metal and rovere grigio finishes, seat in Callas 11 fabric. **Level** table in rovere grigio finish. **Hub** unit in nero grafite matt lacquered finish.

TECHNICAL DATA

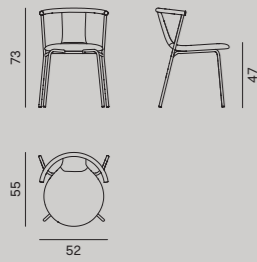

CLOSE-UP

Dettaglio della struttura in metallo della sedia Agel. / Detail of Agel chair's metal frame.



^{IT} Sedie Agel con struttura in metallo laccato ossidato brunito e in finitura rovere carbone, seduta in cuoio finitura scoglio. Tavolo Sunny in laccato ossidato brunito e piano in finitura pietra lavica opaca.

^{EN} Agel chairs with frame in oxidized bronze lacquered metal and rovere carbone finishes, leather seat in scoglio finish. Sunny table in oxidized bronze lacquered finish with matt lava stone top.



Candy

— Design by Novamobili studio



Comoda e versatile, Candy è una sedia imbottita dalle linee classiche e dalle infinite possibilità cromatiche. La struttura è disponibile nelle finiture impiallacciate di rovere, oppure in tutti i colori laccati opachi e ossidati. La seduta imbottita in tessuto.

Comfortable and versatile, Candy is a padded chair with classic lines and an infinite range of colours to choose from. The frame comes in the rovere veneer finishes, or in any of the matt and oxidized lacquered colour options. The padded seat is covered with fabric.





^{IT} Sedia Candy con struttura in finitura rovere grigio e seduta in tessuto Aura 54. Pouf Loto con rivestimento Eva 20. Libreria Pontile con montanti in alluminio brunito, ripiani e listelli frontali in laccato ossidato brunito.

^{EN} Candy chair with frame in rovere grigio finish and seat in Aura 54 fabric. Loto ottoman upholstered in Eva 20. Pontile bookcase with bronze-finish aluminium uprights, shelves and front strips in oxidized bronze lacquered finish.



^{IT} Sedie Candy con struttura in laccato opaco mogano e seduta in tessuto Laila 29 e in finitura rovere carbone con seduta in tessuto Sophie 38.

^{EN} Candy chair with frame in mogano matt lacquered finish and seat in Laila 29 fabric; and in rovere carbone finish with seat in Sophie 38 fabric.



TECHNICAL DATA

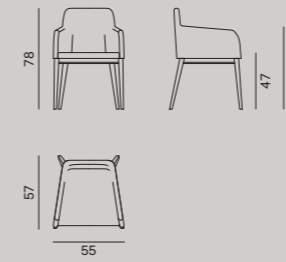

Ellen

— Design by e-ggs



La sedia Ellen si caratterizza per il design moderno e dinamico, in grado di trasformare qualsiasi spazio abitativo. Con la sua struttura monoblocco, Ellen incarna la perfetta fusione tra funzionalità e stile distintivo. Lo schienale curvo, con la sua linea sinuosa e accogliente, avvolge armoniosamente la seduta, regalando un senso di comfort e accoglienza.

The Ellen chair features a distinctive modern, dynamic design with the power to transform any home interior. With its one-piece frame, Ellen embodies the perfect blend of function and characteristic style. With its sinuous, body-hugging lines, the curved backrest wraps harmoniously around the seat, giving the chair a comfortable, welcoming feel.





^{IT} Sedie **Ellen** in finitura rovere terra e seduta in tessuto Aura 11. Tavolo **Rea** in finitura rovere terra e piano in light stone calacatta grey.

^{EN} **Ellen** chairs in rovere terra finish with seat in Aura 11 fabric. **Rea** table in rovere terra finish with calacatta grey light stone top.

TECHNICAL DATA

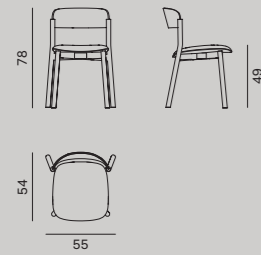

CLOSE-UP

Dettaglio della sedia *Ellen* con struttura in finitura rovere grigio e seduta in tessuto Chloé 06. / *Detail of Ellen chair with frame in rovere grigio finish and seat in Chloé 06 fabric.*



IT Sedie *Ellen* in finitura rovere carbone e seduta in tessuto Dafne 11. Tavolini *Trio* in laccato ossidato brunito e laccato opaco grigio.

EN *Ellen* chairs in rovere carbone finish with seat in Dafne 11 fabric. *Trio* side tables in oxidized bronze lacquered and grigio matt lacquered finishes.



Sedute
Seating

Natt

— Design by Studio Gherardi



L'estetica nordica e l'ampia gamma di colori e tessuti con cui può essere realizzata rendono Natt una sedia perfetta per i diversi spazi della casa. La struttura è disponibile nelle finiture impiallacciate di rovere, oppure in tutti i colori laccati opachi e ossidati; la seduta imbottita in tessuto sfoderabile.

With its Nordic look and wide range of colour and fabric options, Natt is a perfect chair for various spaces in the home. The frame comes in the rovere veneer finishes, or in any of the matt and oxidized lacquered colour options; the padded seat is covered with removable fabric.





^{IT} Sedia **Natt** con struttura in finitura rovere miele e seduta in tessuto Florence 17. Piano sp. 5 cm e basi **Box 18** in finitura rovere miele con vassoio tre lati in laccato opaco foresta. Specchio **Deep** in laccato ossidato bronzo.

^{EN} **Natt** chair with frame in rovere miele finish and seat in Florence 17 fabric. 5cm-thick top and **Box 18** base units in rovere miele finish with foresta matt lacquered 3-sided tray. **Deep** mirror in oxidized light bronze lacquered finish.

IT Sedie Natt con struttura in laccato ossidato brunito e seduta in tessuto Mya 11, in laccato opaco blu notte e seduta in tessuto Calima 05 e in laccato opaco bianco con seduta in tessuto Nora 17. Tavolo Rea in laccato ossidato brunito.

EN Natt chairs with oxidized bronze lacquered frame and seat in Mya 11 fabric; blu notte matt lacquered frame with seat in Calima 05 fabric; and bianco matt lacquered frame with seat in Nora 17 fabric. Rea table in oxidized bronze lacquered finish.

TECHNICAL DATA

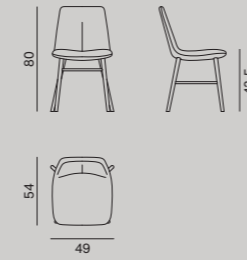

Navy, Navy Tub

— Design by Matteo Zorzenoni



Le sedie Navy e Navy Tub sono state pensate per i diversi ambienti della casa. Alla struttura solida – disponibile nelle finiture impiallacciate di rovere e noce canaletto – si unisce una seduta imbottita dalle linee morbide e dolci, ancora più avvolgenti nella versione Navy Tub. Il rivestimento si può scegliere in tessuto o pelle extra.

The Navy and Navy Tub chairs have been designed for use in various rooms throughout the home. The solid frame — which comes in the rovere veneer and noce canaletto finishes — is paired with a softly and gently curving padded seat, which is even more cocooning on the Navy Tub version. The chairs can be upholstered in a choice of fabric or extra leather.





^{IT} Sedie Navy Tub con struttura in finitura rovere miele e seduta in tessuto Sophie 12. Tavolo Sunny con gambe in laccato metal ottone e piano in light stone bianco.

^{EN} Navy Tub chairs with frame in rovere miele finish and seat in Sophie 12 fabric. Sunny table with legs in brass metal lacquered finish and bianco light stone top.

DETAILS COLLECTION

IT Sedie Navy con struttura in finitura rovere carbone e seduta in tessuto Aura 05. Tavolo Torii in finitura rovere carbone. Madia sospesa composta da basi Box 18 in finitura rovere carbone, vassoio credenza e base Box 18 in laccato opaco blu notte.

EN Navy chairs with frame in rovere carbone finish and seat in Aura 05 fabric. Torii table in rovere carbone finish. Wall-mounted sideboard comprising Box 18 base units in rovere carbone finish, sideboard tray and Box 18 base unit in blu notte matt lacquered finish.



SEDUTE | SEATING



TECHNICAL DATA

– Navy

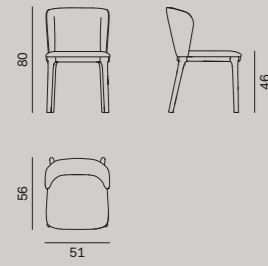

– Navy Tub

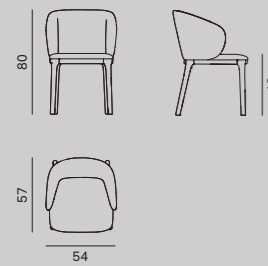

SEDUTE | SEATING

IT Sedie Navy con struttura in finitura rovere bianco e seduta in tessuto Mya 11, in finitura rovere grigio e seduta in tessuto Egle 13, in finitura rovere grigio e seduta in tessuto Callas 13. Tavolo Rea in laccato opaco quarzo.

EN Navy chairs with frame in rovere bianco finish and seat in Mya 11 fabric; rovere grigio frame finish with seat in Egle 13 fabric; and rovere grigio frame with seat in Callas 13 fabric. Rea table in quartz matt lacquered finish.



Rose

— Design by Zanellato/Bortotto



Rose è una sedia dalle linee morbide, frutto di un lavoro in gran parte artigianale: ogni elemento in legno viene rifinito a mano, così come la seduta. La struttura è disponibile nelle finiture impiallacciate di rovere, noce canaletto e in tutti i colori laccati opachi e ossidati.

La seduta può essere imbottita in tessuto, oppure in paglia intrecciata color grafite. Rose è disponibile anche con schienale imbottito.

With its soft lines, the Rose chair has been crafted in large part using old-fashioned workmanship: each wooden element is finished by hand, as is the seat. The frame comes in the rovere veneer finishes, noce canaletto, and in any of the matt and oxidized lacquered colour options.

The seat can be padded and covered in fabric, or can be made from graphite-coloured straw. Rose also comes with the option of a padded back.





IT Sedie Rose con struttura in finitura noce canaletto, seduta e schienale imbottiti in tessuto Egle 18. Tavolo Hanami con gambe in finitura noce canaletto e piano in marmo grigio Oriente opaco. Madia composta da basi Box 18 in laccato opaco foresta, contenitori Outline con scocca e schiena in finitura noce e telaio in laccato opaco foresta, in appoggio su panca sp. 5 cm nella stessa finitura.

EN Rose chairs with frame in noce canaletto finish, padded seat and back in Egle 18 fabric. Hanami table with legs in noce canaletto finish and matt grigio Oriente marble top. Sideboard comprising Box 18 base units in foresta matt lacquered finish, Outline storage units with carcass and back panel in noce finish with foresta matt lacquered frame, sitting on 5cm-thick bench in the same finish.





^{IT} Sedie *Rose* con struttura in finitura rovere chiaro e seduta in tessuto Antibes 18. Tavolo *Hanami* in finitura rovere chiaro.

^{EN} *Rose* chairs with frame in rovere chiaro finish and seat in Antibes 18 fabric. *Hanami* table in rovere chiaro finish.



IT Sedie *Rose* con struttura in finitura rovere carbone e seduta con rivestimento Eva 11, in laccato opaco ambra e seduta in tessuto Laila 39. Pouf *Log* in tessuto *Mya* 17. Tavolo *Filo* in laccato opaco ambra.

EN *Rose* chairs with frame in rovere carbone finish and seat upholstered in Eva 11; and ambra matt lacquered frame with seat in Laila 39 fabric. *Log* ottoman in *Mya* 17 fabric. *Filo* table in ambra matt lacquered finish.

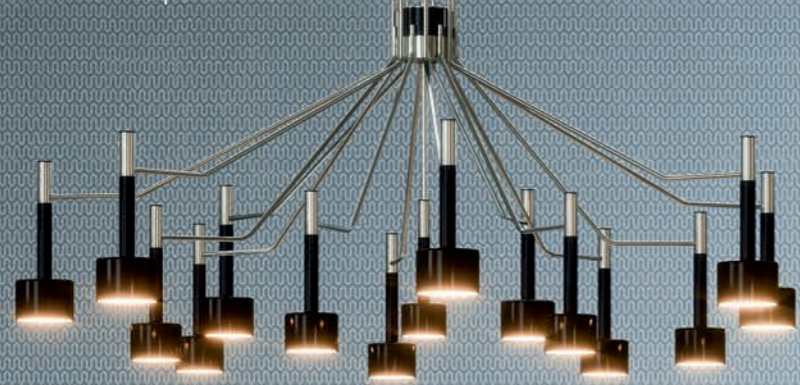

TECHNICAL DATA

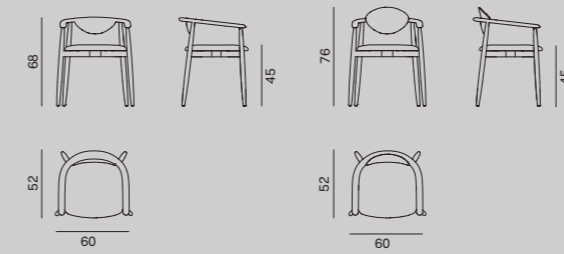

CLOSE-UP

Dettaglio della sedia con struttura in finitura rovere grigio e seduta in paglia intrecciata a mano color grafite. / Detail of chair with frame in rovere grigio finish and handwoven straw seat in graphite.



Time

— Design by Studio Gherardi



Impilabile e sfoderabile, Time è una sedia dai contorni delicati. La struttura è completamente imbottita e rivestita in tessuto o pelle extra: una caratteristica che la rende interessante sia visivamente sia nel tocco, morbido e caldo.

Stackable and featuring removable upholstery, the Time chair features a dainty silhouette. The frame is padded and covered from head to toe with fabric or extra leather: a feature that provides both visual interest and a soft, warm tactile appeal.



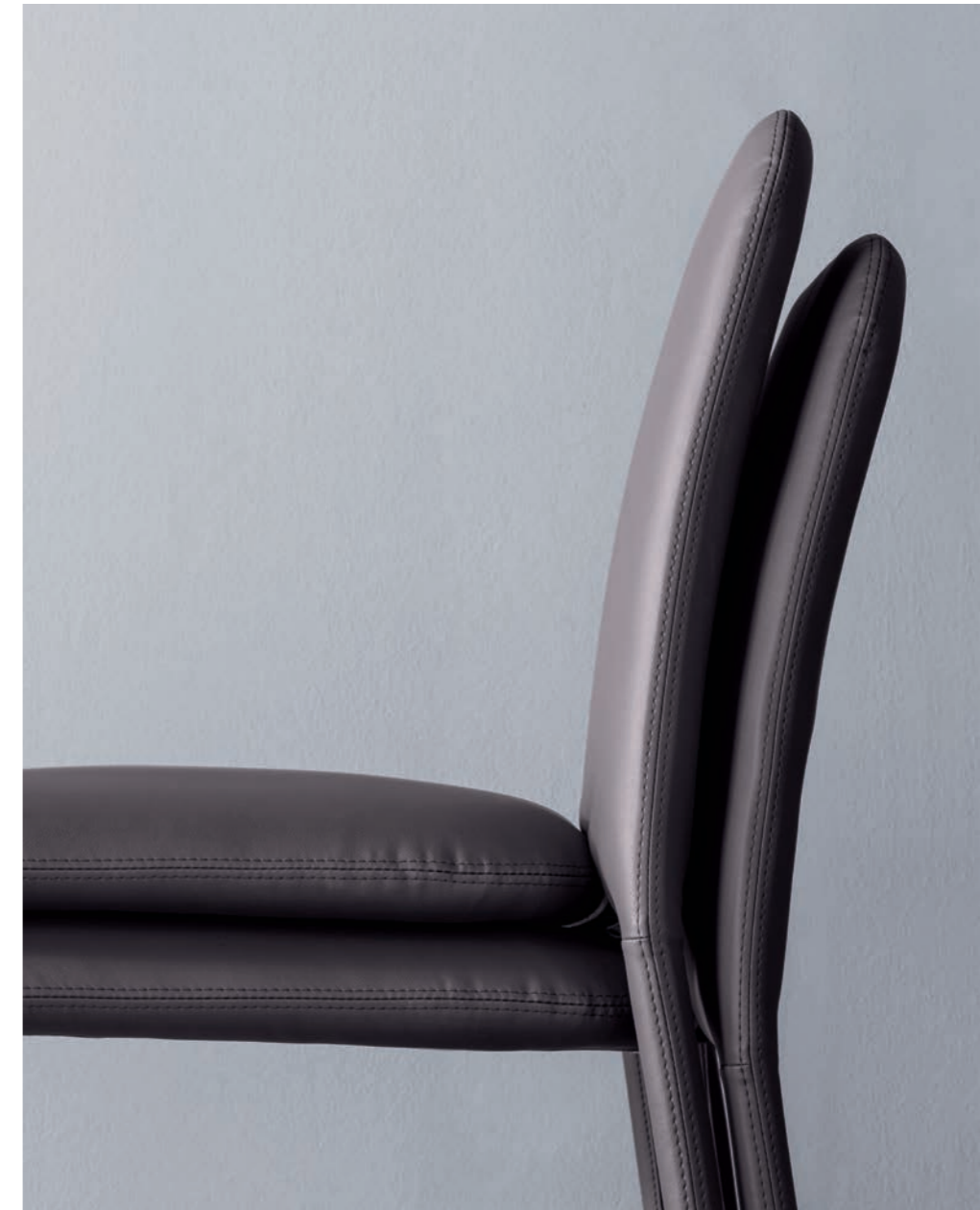

^{IT} Sedie **Time** con rivestimento Eva 20. Tavolo **Filo** in laccato opaco quarzo. Mensole **Ellie** in laccato ossidato brunito.

^{EN} **Time** chairs upholstered in Eva 20. **Filo** table in quartz matt lacquered finish. **Ellie** shelves in oxidized bronze lacquered finish.

TECHNICAL DATA

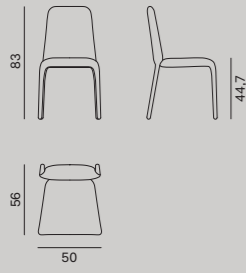

IT Sedie Time in tessuto Iris 11 e tessuto Laila 42.

EN Time chairs in Iris 11 fabric, and in Laila 42 fabric.



Twist

sedia, sgabello, sedia lounge | chair, stool, lounge chair

— Design by Matteo Zorzenoni



Sistema di sedute che reinterpretano le forme degli anni Sessanta. Il design di Twist è reso dinamico dalla particolare inclinazione delle gambe posteriori, che si estendono e si uniscono a sostenere lo schienale. La struttura è disponibile nelle finiture impiallacciate di rovere o noce canaletto; seduta imbottita in tutti i tessuti a catalogo. La sedia lounge Twist è disponibile anche in pelle extra.

Line of seating offering a contemporary take on Sixties shapes. Twist's design draws its dynamic look from the unusually angled legs to the rear, which climb up and join together to support the backrest. The frame comes in the rovere veneer or noce canaletto finishes; the padded seat comes in any of the fabrics from the catalogue. The Twist lounge chair also comes in extra leather.



^{IT} Sedia Twist con struttura in finitura rovere carbone, seduta e schienale in tessuto Calima 05. Tavolo Filo con struttura in laccato opaco nero grafite e piano sp. 0,6 cm in light stone nero. Mensole Ellie in laccato ossidato brunito.

^{EN} Twist chair with rovere carbone frame, seat and back in Calima 05 fabric. Filo table with nero grafite matt lacquered structure and 0,6cm-thick light stone top in nero. Ellie shelves in oxidized bronze lacquered finish.

IT Sedie lounge **Twist** con struttura in finitura rovere grigio e seduta in tessuto Egle 21. Tavolino **Globe** in finitura rovere grigio e gambe in laccato ossidato brunito; tavolino **Globe** con vassoio in laccato opaco ginepro, piano in light stone calacatta grey e gambe in laccato ossidato brunito. Madia **Fjord** in laccato opaco ginepro con schienale del vano a giorno in finitura rovere grigio e basamento in laccato ossidato brunito.

EN **Twist** lounge chairs with frame in rovere grigio finish and seat in Egle 21 fabric. **Globe** occasional table in rovere grigio finish with oxidized bronze lacquered legs; **Globe** occasional table with tray in ginepro matt lacquered finish, calacatta grey light stone top and oxidized bronze lacquered legs. **Fjord** sideboard in ginepro matt lacquered finish with open shelf back panel in rovere grigio finish, and oxidized bronze lacquered base.



Sedute
Seating



^{IT} Dettaglio dello sgabello **Twist** con struttura in finitura noce canaletto, seduta in tessuto Chloé 18. Nella pagina accanto, sgabelli **Twist** con struttura in finitura noce canaletto, seduta in tessuto Chloé 18 e 23.

^{EN} Detail of **Twist** stool with frame in noce canaletto finish, seat in Chloé 18 fabric. Opposite: **Twist** stools with frame in noce canaletto finish, seat in Chloé 18 and 23 fabric.



^{IT} Sedia lounge **Twist** con struttura in finitura rovere chiaro, seduta in tessuto Bonnie 06. Sgabello **Twist** in finitura rovere chiaro con seduta e schienale in tessuto Gaia 39. Piano sospeso sp. 5 cm in finitura rovere chiaro, libreria **Wall 30** in laccato opaco piombo e pouf Log in tessuto Mimì 57.

^{EN} **Twist** lounge chair with frame in rovere chiaro finish, seat in Bonnie 06 fabric. **Twist** stool in rovere chiaro finish with seat and back in Gaia 39 fabric. 5cm-thick wall-mounted top in rovere chiaro finish, **Wall 30** bookcase in piombo matt lacquered finish and Log ottoman in Mimì 57 fabric.

TECHNICAL DATA

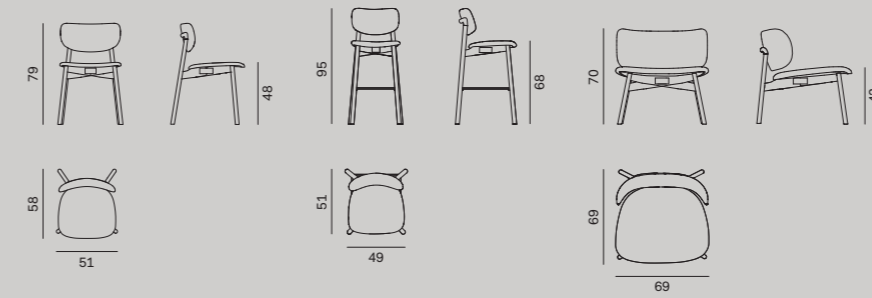

Yoko

— Design by e-ggs



La seduta e lo schienale imbottiti della sedia Yoko avvolgono in modo accogliente, mentre la struttura tubolare sottile le dona un design iconico. È l'ideale per completare un'area salotto o per creare un angolo studio sofisticato. La sedia Yoko rappresenta il connubio perfetto tra funzionalità e stile, offrendo il massimo del comfort senza sacrificare l'estetica.

The padded seat and back on the Yoko chair wrap around the occupant in an inviting embrace, while the slim tubular frame gives it an iconic look. Ideal for adding the finishing touch to a lounge space, it can also be used to create a sophisticated study nook. The Yoko chair is the perfect marriage between function and style, offering unbeatable comfort without sacrificing aesthetics.



Sedute
Seating

^{IT} Sedie Yoko con struttura in metallo laccato ossidato brunito, seduta in tessuto Antibes 11. Tavolo Hanami in finitura rovere chiaro. Madio Bay in laccato opaco foglia e schienale del vano a giorno in finitura rovere chiaro.

^{EN} Yoko chairs with frame in oxidized bronze lacquered metal, seat in Antibes 11 fabric. Hanami table in rovere chiaro finish. Bay sideboard in foglia matt lacquered finish with open shelf back panel in rovere chiaro finish.

TECHNICAL DATA

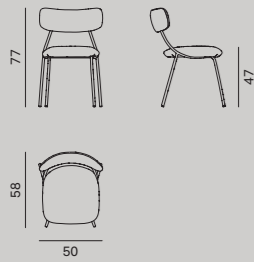

IT Sedie Yoko con struttura in metallo laccato opaco tortora, seduta in tessuto Bonnie 21. Tavolo Filo in laccato opaco tortora e piano in light stone bianco. Pouf Log in tessuto Egle 21 e 29.

EN Yoko chairs with tortora matt lacquered metal frame, seat in Bonnie 21 fabric. Filo table in tortora matt lacquered finish with bianco light stone top. Log ottomans in Egle 21 and 29 fabric.



Church

— Design by Studio Gherardi



Church è una panca imbottita adattabile a molteplici situazioni, dall'ingresso alla cabina armadio, e più in generale come complemento di ambienti dedicati al relax. La seduta, sfoderabile, è rivestita con tutti i tessuti a catalogo. Il basamento è disponibile in tutti i colori laccati opachi, ossidati e metal.

Church is a padded bench that lends itself to a whole host of situations: from the entry hall to the walk-in wardrobe and, more generally speaking, as the perfect occasional piece in spaces made for unwinding. The seat has removable covers, which can be made from any of the fabric options in the catalogue. The base comes in any of the matt, oxidized and metal lacquered colour options.



SEDUTE | SEATING

Sedute
Seating

^{IT} Panca **Church** in tessuto Laila 54 con basamento in laccato ossidato bronzo.

^{EN} **Church** bench in Laila 54 fabric with base in oxidized light bronze lacquered finish.

TECHNICAL DATA

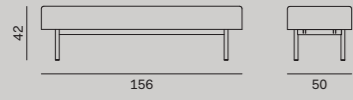

^{IT} Panca Church in tessuto Mya 17 con basamento in laccato opaco corda. Mensola Riga in laccato opaco fango con specchio e appendiabiti in laccato opaco corda. Tavolino Circle in laccato ossidato brunito.

^{EN} Church bench in Mya 17 fabric with base in corda matt lacquered finish. Riga shelf in fango matt lacquered finish with corda matt lacquered mirror and coat hooks. Circle side table in oxidized bronze lacquered finish.

Dora

— Design by Novamobili studio



La panca imbottita Dora, in tessuto sfoderabile, con il suo design moderno e minimalista, conferisce un tocco di eleganza e versatilità ai diversi ambienti della casa. Grazie alla sua confortevole seduta imbottita, è l'ideale anche per abbellire la zona notte o guardaroba. Le gambe, disponibili nelle finiture impiallacciate di rovere e noce canaletto, conferiscono a Dora un design contemporaneo.

With its modern, minimalist design, the Dora padded bench, covered with removable fabric, injects a touch of elegance and versatility into various rooms throughout the home. Its comfortable padded seat also makes it the ideal addition to a bedroom or walk-in wardrobe scheme. The legs, which come in the rovere veneer and noce canaletto finishes, give Dora a contemporary look.

IT Panca **Dora** in tessuto Bonnie 23 e gambe in finitura rovere bianco. Cabina **Break** in finitura oxford.

EN **Dora** bench in Bonnie 23 fabric with legs in rovere bianco finish. **Break** walk-in closet in oxford finish.



DETAILS COLLECTION

IT Panca Dora in tessuto Mya 54 e gambe in finitura rovere grigio. Tavolino Circle in laccato opaco ginepro.

EN Dora bench in Mya 54 fabric with legs in rovere grigio finish. Circle side table in ginepro matt lacquered finish.



SEDUTE | SEATING

TECHNICAL DATA

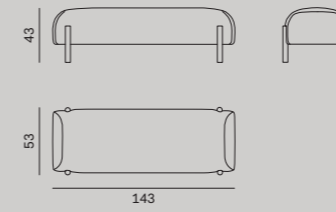

Madie
Sideboards



Bay

— Design by BGR Busetti Garuti Redaelli



La madia Bay si distingue per la sua solida struttura geometrica, che acquisisce un tocco di eleganza grazie al profilo curvo sul retro. Le ante, nelle finiture impiallacciate di rovere e noce canaletto, sono arricchite da un motivo a scanalature, che conferisce un carattere distintivo all'ambiente. Bay offre l'opportunità di creare la combinazione perfetta per ogni progetto d'arredamento ed è disponibile con apertura complanare o ad ante battenti.

The Bay sideboard stands out for its solid geometric structure, which acquires a touch of elegance courtesy of the curved shape of the rear. The doors, in the rovere veneer and noce canaletto finishes, are enhanced with grooved detailing, which gives the interior a distinctive character. With Bay, you have the opportunity to create the perfect pairing for any interior design project and can choose either hinged doors or the flush-closing option.





^{IT} Madia **Bay** con ante dogate complanari in finitura rovere carbone, basamento in laccato ossidato brunito e top in light stone grigio alpi carnia. Poltrona **Hamptons** in tessuto Laila 42 e struttura in finitura rovere carbone. Pouf **Log** in tessuto Mya 11. Nella pagina accanto, ripiano interno in vetro trasparente della madia **Bay**.

^{EN} **Bay** sideboard with flush-closing grooved doors in rovere carbone finish, oxidized bronze lacquered base, and grigio alpi carnia light stone top. **Hamptons** armchair in Laila 42 fabric and frame in rovere carbone finish. **Log** ottoman in Mya 11 fabric. Opposite: transparent glass internal shelf on the **Bay** sideboard.

TECHNICAL DATA

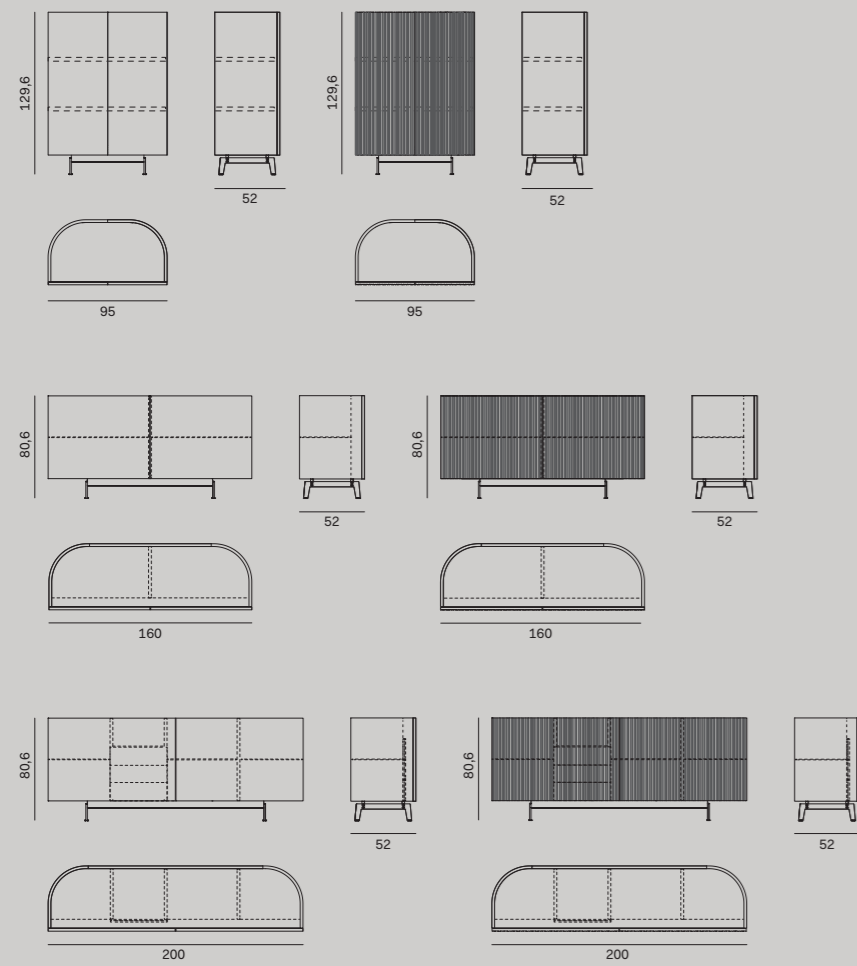

CLOSE-UP

Dettaglio dell'anta dogata battente in finitura rovere miele e piano in cuoio finitura testa di moro. / Detail of the hinged grooved door in rovere miele finish and leather top in testa di moro finish.



IT Madie Bay con anta battente dogata in finitura rovere miele, basamento in laccato ossidato brunito e piano in cuoio in finitura testa di moro. Poltrona Artichoke in tessuto Gaia 21 e Bonnie 21. Pouf Log in tessuto Calima 05.

EN Bay sideboards with hinged grooved doors in rovere miele finish, oxidized bronze lacquered base, and leather top in testa di moro finish. Artichoke armchair in Gaia 21 and Bonnie 21 fabric. Log ottoman in Calima 05 fabric.



Belt

— Design by Philippe Nigro



Belt è una collezione di madie il cui punto di forza è la modularità. La madia, sospesa sul basamento in metallo in tutti i colori laccati opachi, ossidati e metal, presenta diverse configurazioni, ottenute dalla combinazione di ante e cassetti per creare contenitori adatti a ogni ambiente della casa. I frontali sono disponibili in laccato opaco e ossidato oppure, nella versione Rays, anche nelle finiture impiallacciate di rovere e noce canaletto. Con le ante in vetro Era, la madia si trasforma in un'elegante credenza che lascia intravedere l'interno ed è resa ancora più contemporanea dall'illuminazione a LED.

Belt is a collection of sideboards whose strength lies in its modular design. The sideboard — floating on the metal base in any of the matt, oxidized and metal lacquered colour options — comes in various configurations, achieved by combining doors and drawers to create storage units to suit any room in the home. The fronts are available in the matt and oxidized lacquered finishes, while the Rays version has the added option of the rovere veneer and noce canaletto finishes. With the Era glass doors, the sideboard is transformed into an elegant display cabinet that lets the interior shine through, and is given an even more contemporary look by the LED lighting.





^{IT} **Madia Belt** in laccato opaco foglia con ante **Era** in vetro trasparente e telaio in laccato opaco foglia, ripiani retroilluminati e interno in finitura rovere miele, basamento in laccato ossidato brunito. Tavolo **Hanami** con gambe in finitura noce canaletto e piano in marmo grigio Oriente opaco, sedie **Rose** con struttura in finitura noce canaletto, seduta e schienale imbottiti in tessuto Egle 18.

^{EN} **Belt** sideboard in foglia matt lacquered finish with **Era** transparent glass doors featuring foglia matt lacquered frame, backlit shelves, interior in rovere miele finish, and oxidized bronze lacquered base. **Hanami** table with legs in noce canaletto finish and matt grigio Oriente marble top, **Rose** chairs with frame in noce canaletto finish, padded seat and back in Egle 18 fabric.



IT Madia Belt con frontali Rays in laccato opaco blu notte. Mensole Ellie in laccato metal ottone. Pouf Loto in tessuto Sophie 05.

EN Belt sideboard with Rays fronts in blu notte matt lacquered finish. Ellie shelves in brass metal lacquered finish. Loto ottoman in Sophie 05 fabric.



^{IT} Madia **Belt** in laccato opaco cotto, frontale cassetti **Rays** in finitura noce canaletto e basamento in laccato ossidato brunito. Pouf **Loto** in tessuto Callas 20, tavolino **Globe** in laccato ossidato brunito.

^{EN} **Belt** sideboard in cotto matt lacquered finish, **Rays** drawer fronts in noce canaletto finish, and oxidized bronze lacquered base. **Loto** ottoman in Callas 20 fabric, **Globe** occasional table in oxidized bronze lacquered finish.

TECHNICAL DATA



CLOSE-UP

Dettaglio del basamento in metallo in laccato opaco laguna. / Detail of metal base in laguna matt lacquered finish.



IT Madia **Belt** in laccato ossidato peltro con ante Era in vetro cannettato, basamento e telaio in laccato ossidato brunito. Pouf Blossom in tessuto Afrodite 11.

EN **Belt** sideboard in oxidized pewter lacquered finish with Era reeded glass doors; oxidized bronze lacquered base and frame. Blossom ottoman in Afrodite 11 fabric.



TECHNICAL DATA

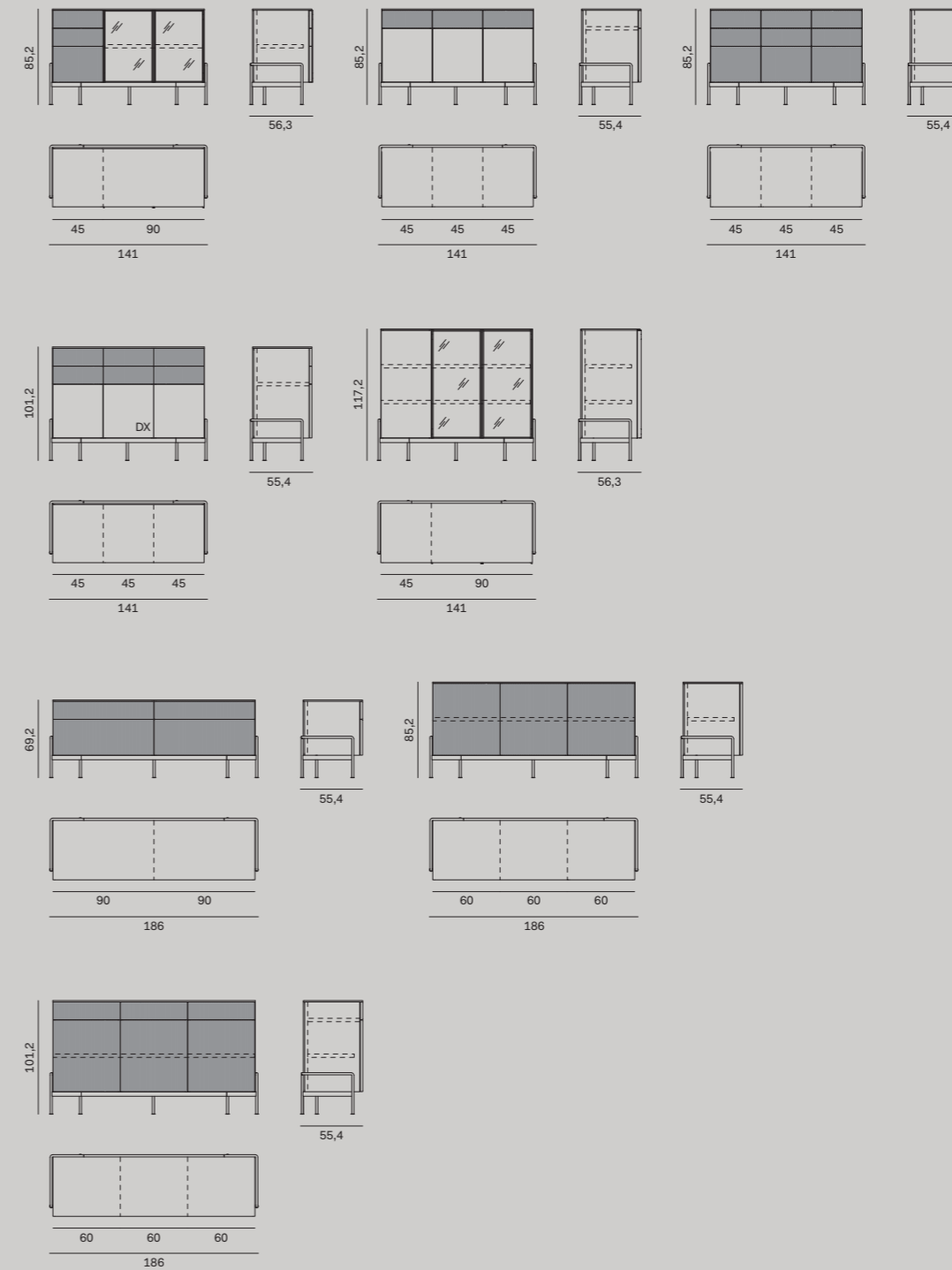

Cleo

— Design by Studio Gherardi



La maniglia sottile e il basamento leggero in metallo sono i dettagli che caratterizzano la madia Cleo, disponibile nelle finiture noce e olmo termotrattato, nelle finiture impiallacciate di rovere, in tutti i colori laccati opachi, lucidi e ossidati, oppure ancora in argilla. Maniglia e basamento si abbinano scegliendo tra le tonalità laccate opache o ossidate per un effetto tono su tono, metal per un tocco prezioso.

The slim handle and light metal base are distinctive details of the Cleo sideboard, which comes in the noce and olmo termotrattato finishes, in the rovere veneer finishes, in any of the matt, gloss and oxidized lacquered colours, or in the clay options. Matt or oxidized lacquered colours can be chosen for the handle and base to match the doors for a tone-on-tone effect, while the metal lacquered option gives a luxe feel.





IT Madie **Cleo** in finitura argilla fumo con maniglie e basamenti in laccato opaco quarzo. Tavolo **Sunny** con gambe in laccato ossidato brunito e piano in pietra lavica nera opaca, sedie **Time** con rivestimento Eva 20.

EN **Cleo** sideboards in fumo clay finish, with quarzo matt lacquered handles and bases. **Sunny** table with oxidized bronze lacquered legs and matt black lava stone top, **Time** chairs upholstered in Eva 20.

TECHNICAL DATA

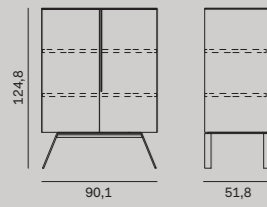

^{IT} Madia Cleo in finitura rovere terra con maniglia e basamento in laccato metal ottone.

^{EN} Cleo sideboard in rovere terra finish with handle and base in brass metal lacquered finish.



Fjord

— Design by BGR Busetti Garuti Redaelli



La madia Fjord si caratterizza per le sue forme sinuose e geometriche che arredano con raffinatezza l'ambiente. È disponibile nella versione con ante e con ante e vano a giorno. Il vano a giorno può essere in tinta o a contrasto ed è disponibile anche nelle finiture impiallacciate di rovere e noce canaletto. La particolarità distintiva di Fjord risiede nel suo design versatile, un classico contemporaneo che conferisce ad ogni ambiente un carattere unico e peculiare.

The Fjord sideboard stands out for its sinuous and geometric shapes, which make a refined addition to the interior scheme. It comes in a version with doors, or with doors and an open shelf. The open shelf can be in a matching or contrasting colour, and can also be ordered in the rovere veneer or noce canaletto finishes. Fjord's distinguishing feature lies in its versatile design, a contemporary classic that brings a unique, distinctive character to any room.



DETAILS COLLECTION

^{IT} Madia Fjord in laccato opaco cotto, schienale del vano a giorno in finitura noce canaletto e basamento in laccato ossidato brunito. Nella pagina accanto, dettaglio dell'interno in laccato opaco cotto e ripiano in vetro trasparente.

^{EN} Fjord sideboard in cotto matt lacquered finish; open shelf back panel in noce canaletto finish, and oxidized bronze lacquered base. Opposite: detail of interior in cotto matt lacquered finish and transparent glass shelf.



MADIE | SIDEBOARDS





^{IT} Madia Fjord in laccato opaco bianco con schienale del vano a giorno in finitura rovere carbone e basamento in laccato ossidato brunito. Tavolino Trio in laccato opaco bianco. Poltrona Artichoke con rivestimento Eva 11.

^{EN} Fjord sideboard in bianco matt lacquered finish with open shelf back panel in rovere carbone finish, and oxidized bronze lacquered base. Trio side table in bianco matt lacquered finish. Artichoke armchair upholstered in Eva 11.



IT Madia **Fjord** in laccato opaco corda e piedini in laccato ossidato brunito. Pouf **Log** in tessuto Callas 13. Tavolino **Trio** in laccato opaco fango.

EN **Fjord** sideboard in corda matt lacquered finish, and oxidized bronze lacquered feet. **Log** ottoman in Callas 13 fabric. **Trio** side table in fango matt lacquered finish.

TECHNICAL DATA

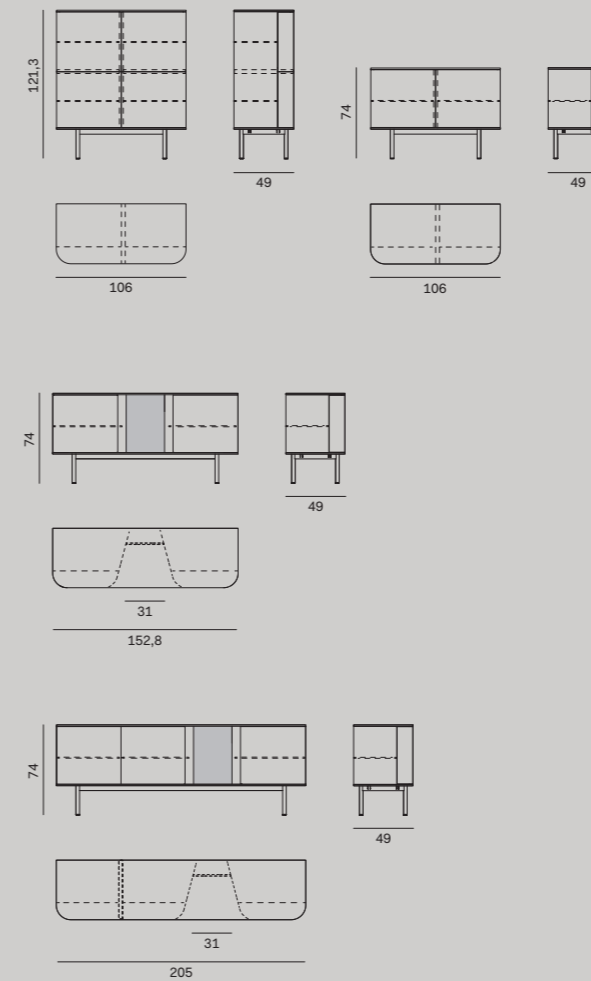

CLOSE-UP

Dettaglio degli interni in laccato opaco corda e ripiani in vetro trasparente. / Detail of interior in corda matt lacquered finish and transparent glass shelves.



Float

— Design by Zaven



La madia Float gioca sul concetto di sostegno e contenitore: il basamento diventa elemento progettuale da valorizzare ed esporre, rendendone visibile la funzione. La madia è disponibile in tre larghezze e in tutti i colori laccati opachi e ossidati; il basamento è anche in laccato metal.

The Float sideboard plays with the concept of support and storage: the base becomes a design element to be shown off to full effect, putting its function on display. The sideboard comes in three widths and in any of the matt or oxidized lacquered colours; the base also comes in the metal lacquered finish.



IT Madia Float in laccato ossidato peltro con basamento in laccato ossidato brunito. Libreria Wall 30 in laccato opaco piombo. Poltrona Haiku con scocca in tessuto Egle 06, cuscini in tessuto Egle 18 e basamento in laccato ossidato brunito. Tavolino Fly in finitura rovere carbone.

EN Float sideboard in oxidized pewter lacquered finish with oxidized bronze lacquered base. Wall 30 bookcase in piombo matt lacquered finish. Haiku armchair with shell in Egle 06 fabric, cushions in Egle 18 fabric and base in oxidized bronze lacquered finish. Fly occasional table in rovere carbone finish.



TECHNICAL DATA

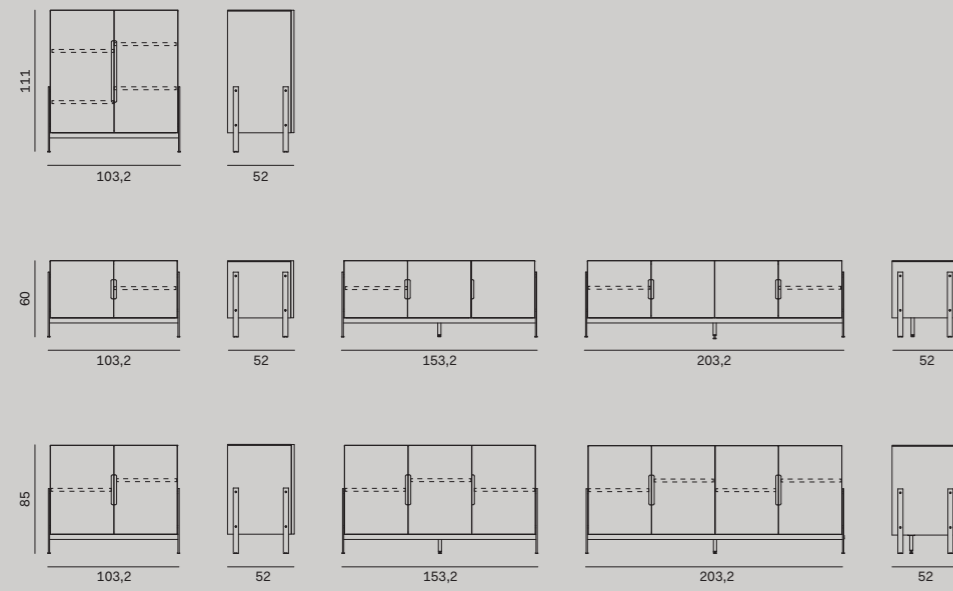

IT Madia Float in laccato opaco mogano. Poltrona Blossom in tessuto Frida 13.

EN Float sideboard in mogano matt lacquered finish. Blossom armchair in Frida 13 fabric.



Reverse

— Design by Studio Gherardi



Ispirata alle madie anni Cinquanta, Reverse è proposta in tre misure. L'alternanza di pieni e vuoti moltiplica le combinazioni cromatiche. La sua linea pulita la rende adatta a tutti gli ambienti della casa, consentendo di ordinare in maniera funzionale tutti gli oggetti.

Inspired by Fifties sideboards, Reverse comes in a choice of three sizes. An alternating succession of solid elements and voids allows for multiple colourways. Its clean lines mean it sits happily in any room of the house, providing a tidy and functional home for all your belongings.



DETAILS COLLECTION

IT Madia **Reverse** in finitura noce canaletto, scocca e vani a giorno in laccato opaco mogano, basamento in laccato ossidato brunito. Sedia **Navy Tub** con struttura in finitura noce canaletto e seduta in tessuto Mya 57. Nella pagina accanto, dettaglio dell'interno in laccato opaco mogano.

EN **Reverse** sideboard in noce canaletto finish, carcass and open shelf in mogano matt lacquered finish, with oxidized bronze lacquered base. **Navy Tub** chair with noce canaletto finish frame and seat in Mya 57 fabric. Opposite: detail of interior in mogano matt lacquered finish.



MADIE | SIDEBOARDS





^{IT} Madia **Reverse** in finitura rovere carbone con frontali, scocca, vani a giorno e basamento in laccato ossidato peltro. Pouf **Log** in tessuto Callas 11. Libreria **Wall 30** e tavolino **Trio** in laccato opaco nero grafite.

^{EN} **Reverse** sideboard in rovere carbone finish with oxidized pewter lacquered fronts, carcass, open shelf and base. **Log** ottoman in Callas 11 fabric. **Wall 30** bookcase and **Trio** side table in nero grafite matt lacquered finish.

TECHNICAL DATA

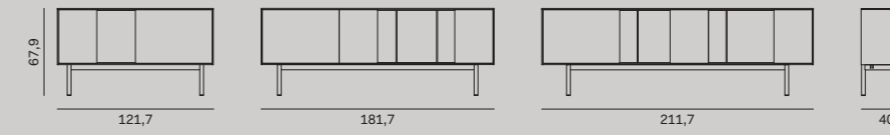

Shadows

— Design by Giopato & Coombes



Come una cornice, un'elegante gola racchiude e definisce il perimetro di Shadows. La madia, disponibile in due dimensioni che uniscono ante e cassetti, è proposta in tutti i colori laccati opachi e ossidati con basamento nelle stesse finiture o in laccato metal.

Like a frame, an elegant recess runs all the way round the edge of the doors, outlining the Shadows unit. The sideboard – which comes in two sizes, combining doors and drawers – is available in any of the matt and oxidized lacquered colour options and has a base in the same finish or one of the metal lacquered colours.





^{IT} Madia *Shadows* con struttura e basamento in laccato opaco grigio e frontali in laccato opaco blu notte.

^{EN} *Shadows* sideboard with structure and base in grigio matt lacquered finish, and blu notte matt lacquered fronts.

DETAILS COLLECTION

TECHNICAL DATA

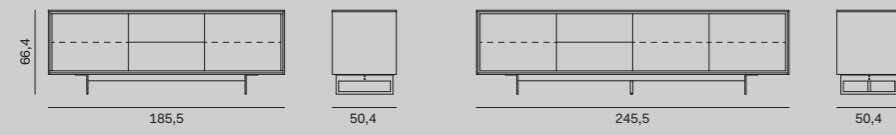

MADIE | SIDEBOARDS

IT Madia Shadows in laccato opaco visone.

EN Shadows sideboard in visone matt lacquered finish.



Madie
Sideboards

Stripe

— Design by Tormena Neadesign



Il basamento sottile e le linee verticali caratterizzano il disegno della madia Stripe, disponibile a tre o quattro ante. Numerose le finiture disponibili, che offrono infinite possibilità di personalizzazione. Alla struttura, in tutti i colori laccati opachi, lucidi e ossidati, si abbina il top nelle stesse finiture, in noce e olmo termotrattato, oppure ancora in tutte le tonalità del rovere o in noce canaletto, in marmo, pietra lavica, light stone, argilla o cuoio. Il basamento è proposto in laccato opaco, ossidato o metal.

The slim base and vertical lines are the distinguishing design features of the Stripe sideboard, which comes in a three- or four-door version. There are numerous finishes on offer, providing endless scope for customizing. The structure – in any of the matt, gloss and oxidized lacquered colour options – is paired with a top in the same finish, in the noce or olmo termotrattato finish, or any of the various rovere options, in addition to noce canaletto finish, marble, lava stone, light stone, clay or leather. The base comes in the matt, oxidized or metal lacquered finishes.





^{IT} Madia Stripe in laccato opaco bianco con top in marmo bianco di Carrara opaco e basamento in laccato ossidato brunito. Divano Reef in tessuto Gaia 21.

^{EN} Stripe sideboard in bianco matt lacquered finish with matt bianco Carrara marble top and base in oxidized bronze lacquered finish. Reef sofa in Gaia 21 fabric.



^{IT} Madia Stripe in laccato opaco piombo con top in cuoio finitura scoglio. Libreria Pontile con montanti in alluminio brunito, ripiani e listelli frontali in laccato ossidato brunito. Poltrona Haiku in tessuto Mimi 54, basamento in laccato ossidato brunito.

^{EN} Stripe sideboard in piombo matt lacquered finish with leather top in scoglio finish. Pontile bookcase with bronze-finish aluminium uprights, shelves and front strips in oxidized bronze lacquered finish. Haiku armchair in Mimi 54 fabric, base in oxidized bronze lacquered finish.

IT Madia Stripe in laccato opaco cenere con top in finitura noce canaletto. Pouf Loto in tessuto Sophie 12.

EN Stripe sideboard in cenere matt lacquered finish with top in noce canaletto finish. Loto ottoman in Sophie 12 fabric.



TECHNICAL DATA

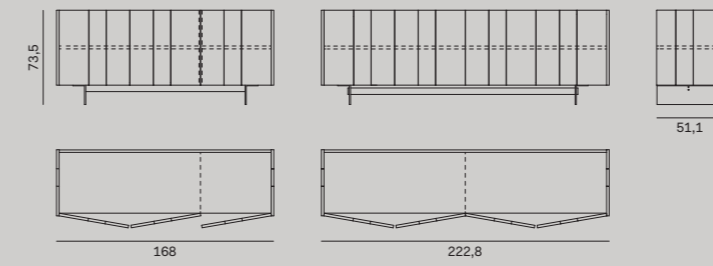

Tavolini

Occasional tables



Alice

— Design by e-ggs

Il tavolino Alice con la sua estetica unica, aggiunge un elemento di creatività e funzionalità all'ambiente circostante. Le linee pulite e l'aspetto minimalista si combinano armoniosamente per creare un punto focale accattivante in ogni stanza. La sua struttura solida non solo offre un supporto affidabile, ma dona anche un senso di leggerezza visiva all'ambiente. Alice si adatta con eleganza a una vasta gamma di stili d'arredamento, contribuendo a trasformare gli spazi con un equilibrio perfetto tra forma e funzione.

With its unique aesthetic, the Alice occasional table graces its surroundings with a dose of creativity and function. The clean lines and minimalist look merge harmoniously to create an eye-catching focal point in any room. Its sturdy structure not only offers a reliable set-down space, but also makes the interior feel visually light. Alice blends elegantly with an extensive range of decor styles, helping transform spaces with a perfect balance between form and function.



TECHNICAL DATA

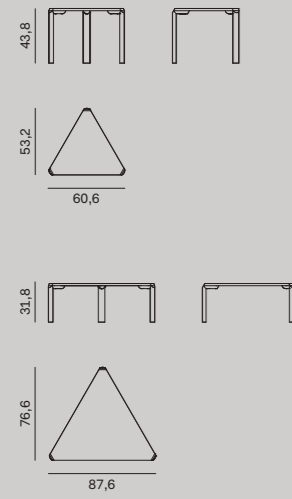

CLOSE-UP

Dettaglio della struttura in finitura rovere carbone. / Detail of structure in rovere carbone finish.

^{IT} Tavolini Alice in finitura rovere miele. Divano Noa in tessuto Affrodite 05.

^{EN} Alice occasional tables in rovere miele finish. Noa sofa in Afrodite 05 fabric.



Tavolini Occasional tables

Allout

— Design by Novamobili studio

Allout è un tavolino versatile: d'appoggio per la zona giorno, diventa un capiente comodino per la zona notte. La sua forma circolare consente di sfruttare al meglio lo spazio interno grazie al cassetto con presa sul bordo superiore dell'anta. È disponibile in tutti i colori laccati opachi.

Allout is a versatile occasional table: serving as a useful set-down space in the living room, it turns into a capacious bedside table in the bedroom. Its circular shape means it has plenty of storage space inside, which is exploited to the full with a drawer featuring a grip edge at the top of the front. It is available in any of the matt lacquered colour options.





IT Tavolino Allout in laccato opaco bianco. Letto Hide in tessuto Callas 57.

EN Allout occasional table in bianco matt lacquered finish. Hide bed in Callas 57 fabric.

TECHNICAL DATA

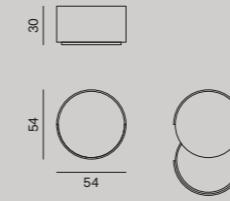

Balance

— Design by e-ggs

Il tavolino Balance, declinato in tre dimensioni, offre numerose possibilità di composizione. Permette di personalizzare l'ambiente accostando soluzioni monocromatiche o a contrasto, conferendo dinamismo agli spazi. La sua versatilità si traduce in un design adattabile a molteplici stili, che aggiunge un tocco distintivo allo spazio.

The Balance occasional table, which comes in three sizes, offers numerous configuration options. It can be used to add a personal touch to the room by pairing solutions in a matching colour or contrasting palette, giving spaces a dynamic feel. Its versatility translates into a design that sits happily alongside many different styles, adding a distinctive touch to the space.



TECHNICAL DATA

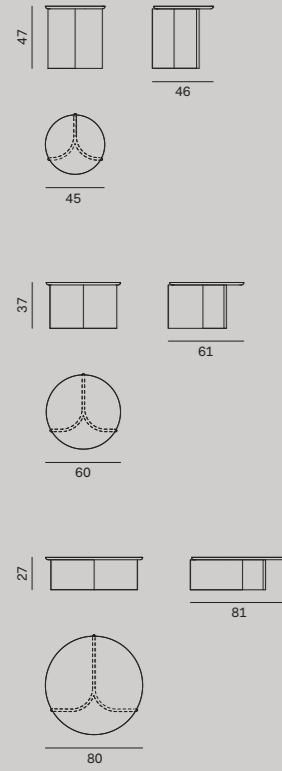

CLOSE-UP

Dettaglio della struttura in finitura rovere chiaro. / Detail of structure in rovere chiaro finish.



^{IT} Tavolini Balance in finitura rovere grigio, in laccato opaco cotto e in laccato ossidato peltro. Divano Blossom in tessuto Iris 11.

^{EN} Balance occasional tables in rovere grigio finish, cotto matt lacquered and oxidized pewter lacquered finishes. Blossom sofa in Iris 11 fabric.

Circle

— Design by Studio Gherardi

Il tavolino Circle si caratterizza per il design semplice e moderno. La struttura in metallo, nei diversi colori laccati opachi, ossidati e metal, sostiene un doppio piano di forma circolare che lo rende pratico accanto al divano, ma anche come comodino.

The Circle occasional table features a simple, modern design. The metal structure, in the various matt, oxidized and metal lacquered colour options, supports circular tops in a two-tier arrangement, which makes it a practical addition beside the sofa, as well as a handy bedside table.



IT Tavolino Circle in laccato ossidato brunito. Libreria Wall 12 in laccato opaco quarzo e poltrona Reef in tessuto Victoria 06.

EN Circle occasional table in oxidized bronze lacquered finish. Wall 12 bookcase in quartz matt lacquered finish and Reef armchair in Victoria 06 fabric.



TECHNICAL DATA



IT Tavolino Circle in laccato metal
ottone. Letto Brick in tessuto
Egle 21.

EN Circle occasional table in brass
metal lacquered finish. Brick bed
in Egle 21 fabric.

Cliff

— Design by Matteo Zorzenoni

La collezione di tavolini Cliff nasce dall'idea di portare nell'ambiente domestico un oggetto dall'aspetto monolitico e dalla forte personalità. Realizzato in poliuretano, è disponibile in due altezze e nelle finiture laccate opache oppure ossidate. Grazie alle sue forme dolci e alle svariate cromie in cui è presentato caratterizza qualsiasi spazio in cui viene collocato.

The Cliff occasional table collection evolved from the idea of bringing a monolithic-looking object with a strong personality into a home interior. Made from polyurethane, it comes in two heights and either the matt or oxidized lacquered finishes. With its soft shapes and wide range of colour options, it adds character to whatever space it is set in.

IT Tavolini Cliff in laccato ossidato peltro e laccato opaco sabbia. Poltrona Velvet in tessuto Florence 28.

EN Cliff occasional tables in oxidized pewter lacquered and sabbia matt lacquered finishes. Velvet sofa in Florence 28 fabric.



TECHNICAL DATA

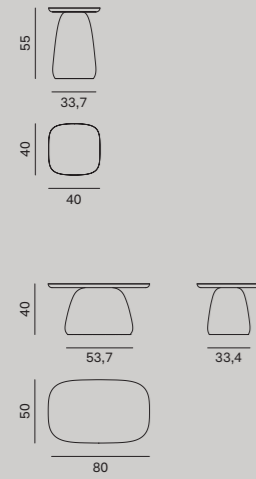

^{IT} Tavolini *Cliff* in laccato ossidato peltro e in laccato opaco ambra. Poltrona *Reef* in tessuto Mimì 11.

^{EN} *Cliff* occasional tables in oxidized pewter lacquered and ambra matt lacquered finishes. Reef armchair in Mimì 11 fabric.



Tavolini
Occasional tables

Fly

— Design by Zaven

Fly è una collezione di tavolini composta di numerosi elementi, da usare singolarmente o accostare tra loro. La semplicità della giunzione tra le gambe e il piano permette di progettare molte combinazioni, scegliendo tra diverse altezze, forme e materiali. Le gambe sono disponibili in tutte le finiture impiallacciate di rovere e in noce canaletto. Il piano – rotondo o ovale – nella stessa finitura delle gambe, in marmo o in pietra lavica.

Fly is a collection of occasional tables made up of numerous elements, for use on their own or in groupings. The simplicity of the joint between the legs and top means you can design countless combinations, choosing from different heights, shapes and materials. The legs are available in any of the rovere veneer and noce canaletto finishes. The top – round or oval – can be in the same finish as the legs, or in marble or lava stone.





IT Tavolini Fly in finitura rovere carbone e con gambe in finitura rovere carbone e piano in pietra lavica opaca. Poltrona Artichoke con rivestimento Eva 11. Divano Noa in tessuto Sophie 18. Libreria Wall 30 in laccato opaco piombo, boiserie in finitura rovere carbone e basi Box 18 in laccato ossidato brunito.

EN Fly occasional tables: one in rovere carbone finish and one with matt lava stone top on rovere carbone legs. Artichoke armchair upholstered in Eva 11. Noa sofa in Sophie 18 fabric. Wall 30 bookcase in piombo matt lacquered finish, wall panelling in rovere carbone finish and oxidized bronze lacquered Box 18 base units.

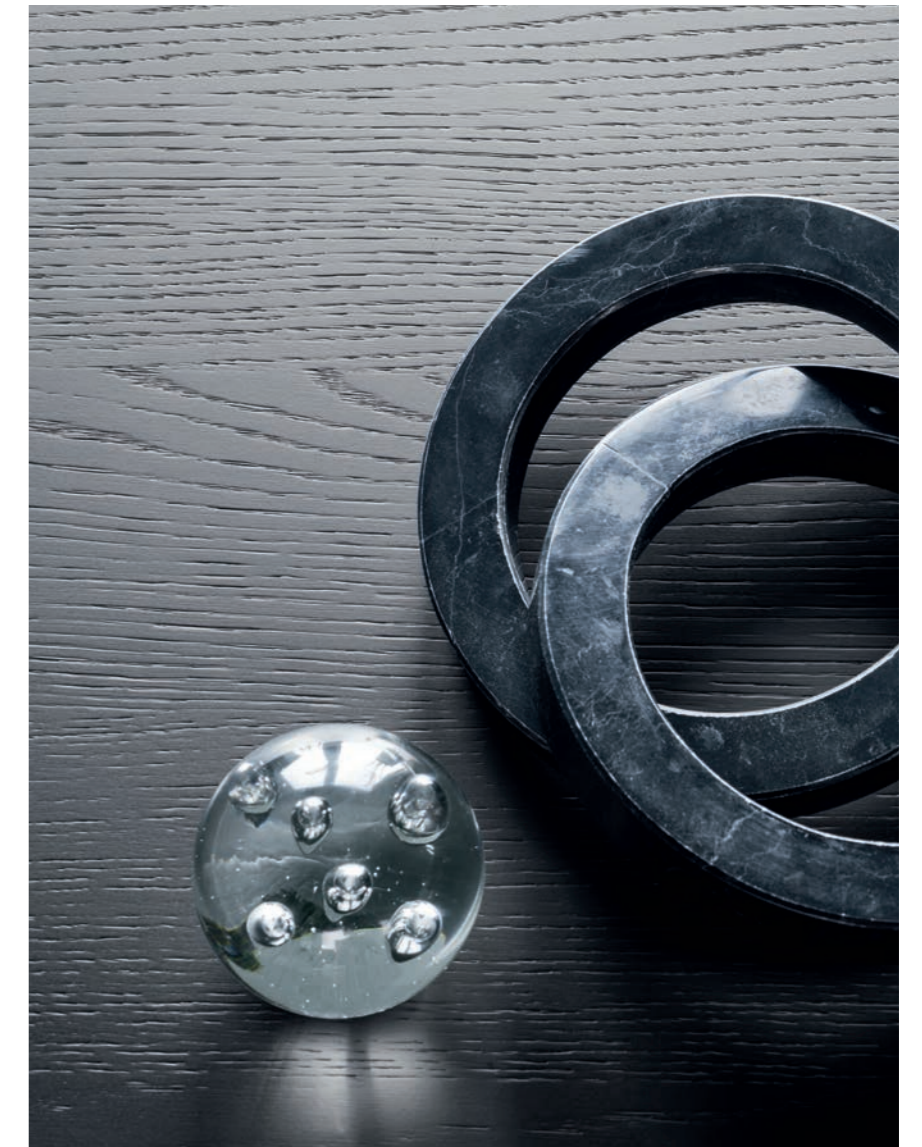

IT Tavolini *Fly* con gambe in finitura noce canaletto e piano in marmo bianco di Carrara opaco, e in finitura noce canaletto. Tavolino *Fly* con gambe in finitura noce canaletto e piano in marmo verde Guatemala opaco. Divano *Mac* in tessuto Afrodite 11.

EN *Fly* occasional tables with legs in noce canaletto finish; one with top in matt bianco Carrara marble, and one in noce canaletto finish. *Fly* occasional table with legs in noce canaletto finish and matt verde Guatemala marble top. *Mac* sofa in Afrodite 11 fabric.



TECHNICAL DATA

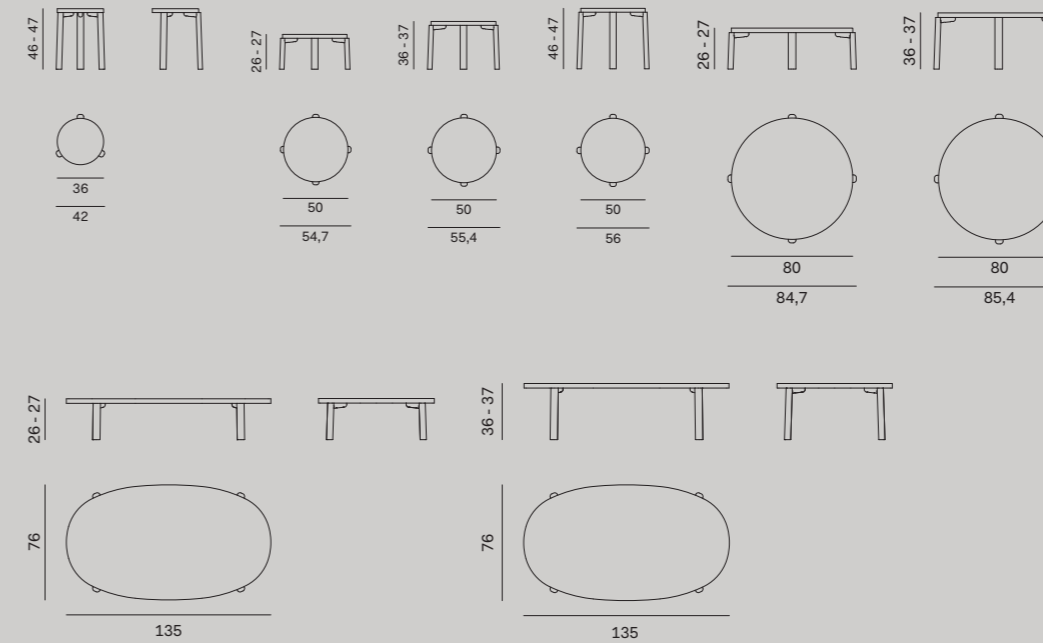

Globe

— Design by Novamobili studio

Globe è una collezione di tavolini dal gusto ricercato e moderno. La struttura essenziale a T – in metallo laccato opaco, ossidato o metal – sostiene un piano spesso 5 cm nelle finiture impiallacciate di rovere, noce canaletto o argilla, oppure un vassoio in metallo, che a sua volta accoglie un piano in finitura noce o olmo termotrattato, in impiallacciato di rovere e noce canaletto, laccato opaco, ossidato e lucido oppure ancora in light stone, marmo, pietra lavica o cuoio. Disponibile in tre diametri e tre altezze, Globe è un tavolino davvero trasversale, adatto a stili e ambienti diversi.

Globe is a collection of occasional tables with a stylish, modern feel. The pared-back T-shaped structure — in the matt, oxidized or metal lacquered finish — supports a 5cm-thick top in either one of the rovere veneer, noce canaletto or clay finishes, or a metal tray, which in turn accommodates an insert in one of the following finishes: noce or olmo termotrattato, rovere veneer or noce canaletto finishes, matt, oxidized or gloss lacquered finish, or one of the light stone, marble, lava stone or leather options. Available in a choice of three diameters and three heights, Globe is a truly cross-functional occasional table, suiting different styles and rooms.





IT Sullo sfondo, tavolino **Globe** in laccato opaco blu notte. In primo piano, tavolini **Globe** con struttura in laccato ossidato brunito e piano per vassoio in marmo bianco di Carrara lucido, con struttura in laccato ossidato brunito e piano sp. 5 cm in finitura noce canaletto. Divano **Noa** in tessuto Chloé 57. Pouf **Loto** in tessuto Sophie 05. Contenitore sospeso **Outline** in laccato ossidato brunito.

EN In the background: **Globe** side table in blu notte matt lacquered finish. In the foreground, **Globe** occasional tables with oxidized bronze lacquered structure and polished Carrara marble tray top; with oxidized bronze lacquered structure and 5cm-thick top in noce canaletto finish. **Noa** sofa in Chloé 57 fabric. **Loto** ottoman in Sophie 05 fabric. **Outline** wall unit in oxidized bronze lacquered finish.

TECHNICAL DATA

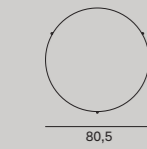
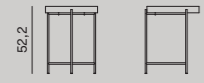

^{IT} Tavolini Globe: in laccato ossidato brunito, struttura in laccato ossidato brunito e piano sp. 5 cm in finitura argilla lapis, struttura in laccato ossidato brunito e piano per vassoio in light stone calacatta grey opaco. Pouf Avenue in tessuto Iris 11.

^{EN} Globe occasional tables: in oxidized bronze lacquered finish; oxidized bronze lacquered structure paired with 5cm-thick top in lapis clay finish; oxidized bronze lacquered structure paired with matt calacatta grey light stone tray insert. Avenue ottoman in Iris 11 fabric.

Kin

— Design by Zanellato/Bortotto

Per il suo aspetto sofisticato, il tavolino Kin è pensato per essere protagonista al centro della zona living. Le sottili gambe in metallo sostengono due piani posti ad altezze diverse, in quattro diverse configurazioni. Le gambe sono disponibili in laccato opaco, ossidato e metal, mentre i piani in finitura olmo termotrattato o noce, oltre che in laccato opaco, ossidato, lucido e metal.

With its sophisticated appearance, the Kin coffee table has been designed to take centre stage in the living room. The slim metal legs support two tops placed at different heights, in four different configurations. The legs come in the matt, oxidized and metal lacquered finishes, while tops are available in the olmo termotrattato or noce finish, in addition to the matt, oxidized, gloss and metal lacquered options.

^{IT} Tavolino *Kin* con gambe in laccato opaco ginepro e piani in laccato opaco e lucido ginepro. Tavolino *Kin* con gambe in laccato metal ottone e piani in laccato opaco foresta e in finitura noce. Divano *Mac* in tessuto Bonnie 06 con cuscini nei tessuti Chloé 08 e 21.

^{EN} *Kin* coffee table with ginepro matt lacquered legs and tops in ginepro matt and gloss lacquered finishes. *Kin* coffee table with brass metal lacquered legs and tops in foresta matt lacquered and noce finishes. *Mac* sofa in Bonnie 06 fabric with cushions in Chloé 08 and 21 fabrics.



Tavolini
Occasional tables

IT Tavolino Kin con gambe in laccato opaco ambra e piani nella medesima finitura e in laccato opaco bianco. Tavolino Kin con gambe in laccato opaco blu notte e piani in laccato lucido e opaco blu notte. Divano e pouf Blossom in tessuto Calima 05. Libreria Butterfly in finitura rovere chiaro.

EN Kin coffee table with ambra matt lacquered legs paired with tops in the same finish and in bianco matt lacquered finish. Kin coffee table with blu notte matt lacquered legs paired with tops in blu notte gloss and matt lacquered finishes. Blossom sofa and ottoman in Calima 05 fabric. Butterfly bookcase in rovere chiaro finish.





TECHNICAL DATA

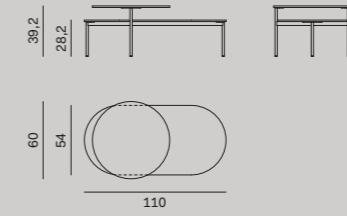
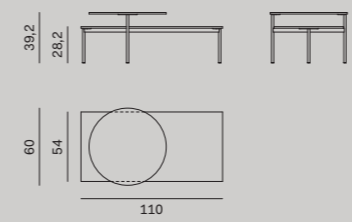
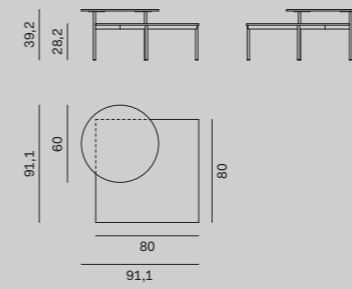
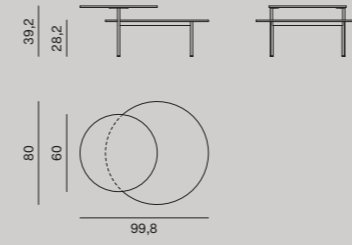

Orbis

— Design by Studio Gherardi

Orbis è una collezione di tavolini circolari resi particolari dall'asimmetria delle gambe. Con due altezze e un'ampia gamma di finiture, permette di creare soluzioni sempre diverse che danno ritmo alla zona living. Il piano è disponibile in tutte le varianti laccate, in finitura noce e olmo termotrattato, in impiallacciato di rovere e noce canaletto, in argilla, light stone, marmo e pietra lavica. Le gambe in laccato opaco, ossidato e metal.

Orbis is a collection of circular occasional tables that owe their quirky look to the asymmetry of the legs. With two heights and an extensive range of finishes to choose from, you can create a never-ending array of solutions to bring the living area to life. The top is available in any of the lacquered options, in the noce and olmo termotrattato finishes, in the rovere veneer and noce canaletto finishes, as well as in clay, light stone, marble and lava stone. Legs come in the matt, oxidized and metal lacquered finishes.



^{IT} Tavolini Orbis in laccato ossidato brunito e con gambe in laccato opaco ginepro e piano in marmo verde Guatemala opaco. Pouf Log in tessuto Calima 17. Mensole Ellie in laccato ossidato brunito.

^{EN} Orbis occasional tables in oxidized bronze lacquered finish and with matt verde Guatemala marble top on ginepro matt lacquered legs. Log ottoman in Calima 17 fabric. Ellie shelves in oxidized bronze lacquered finish.

TECHNICAL DATA

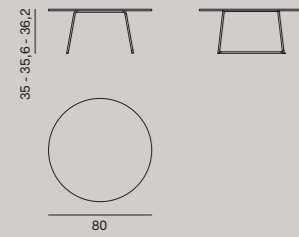
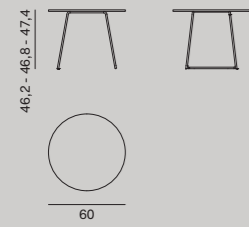

CLOSE-UP

Dettaglio dei piani dei tavolini *Orbis* in finitura argilla arena e in light stone emperador. / Detail of *Orbis* occasional table tops in arena clay finish and emperador light stone.

^{IT} Tavolino *Orbis* in laccato opaco tortora. Tavolini *Orbis* con gambe in laccato metal brown e piano in finitura argilla arena e in light stone emperador. Divano *Avenue* in tessuto Chloé 01.

^{EN} *Orbis* occasional table in tortora matt lacquered finish. *Orbis* occasional tables with brown metal lacquered legs paired with tops in arena clay finish and emperador light stone. *Avenue* sofa in Chloé 01 fabric.



Tavolini
Occasional tables

Seven

— Design by Studio Gherardi

Il tavolino Seven, nella sua duplice versione quadrata e rettangolare, appare come un monolite scavato e leggermente sollevato da terra. Si caratterizza per il gioco cromatico dei materiali tra scocca interna ed esterna, vani a giorno e vassoi estraibili. È disponibile nelle finiture noce e olmo termotrattato e in tutti i colori laccati opachi e ossidati.

The Seven coffee table – in both square and rectangular versions – has the appearance of a carved-out solid block hovering just above the floor. Its distinguishing feature is the juxtaposition of colour between the materials of the interior and exterior, open shelving and pull-out trays. It comes in the noce and olmo termotrattato finishes, and in any of the matt and oxidized lacquered colour options.

IT Tavolini Seven in laccato ossidato peltro con vassoi in finitura olmo termotrattato. Poltrona Origin in tessuto Aura 05 e divano Mac in tessuto Antibes 08.

EN Seven coffee tables in oxidized pewter lacquered finish with trays in olmo termotrattato finish. Origin armchair in Aura 05 fabric and Mac sofa in Antibes 08 fabric.



Tavolini
Occasional tables

IT Tavolini Seven in finitura olmo termotrattato con vassoi in laccato ossidato bronzo. Divano Mac in tessuto Afrodite 01. Pouf Log con rivestimento Eva 11.

EN Seven coffee tables in olmo termotrattato finish with oxidized light bronze lacquered trays. Mac sofa in Afrodite 01 fabric. Log ottoman upholstered in Eva 11.



TECHNICAL DATA

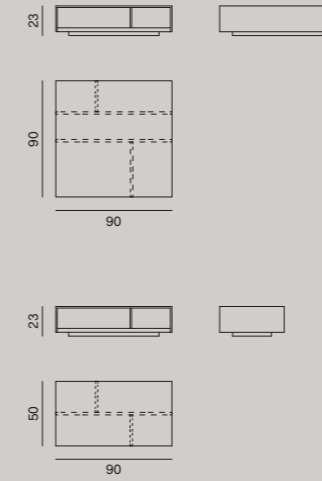

CLOSE-UP

Dettaglio dei vassoi in laccato ossidato bronzo. / Detail of trays in oxidized light bronze lacquered finish.

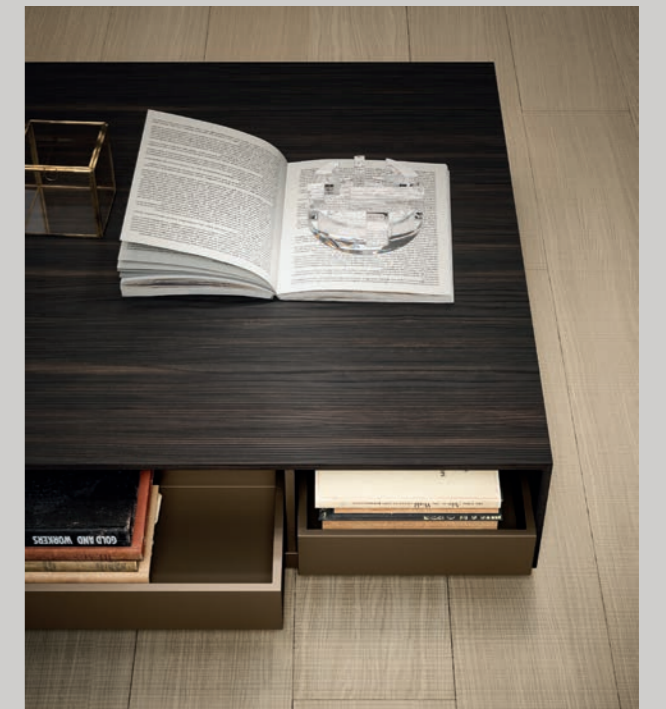

Shadows

— Design by Giopato & Coombes

Shadows è un tavolino dalla forma semplice e regolare, costituito da due parallelepipedi sovrapposti che, leggermente sollevati da terra, creano un interessante gioco di ombre sul pavimento. È disponibile in tutti i colori laccati opachi e ossidati, argilla e in impiallacciato di rovere e noce canaletto.

Shadows is a coffee table with a simple, regular-shaped design consisting in two parallelepipeds, one sitting on top of the other and raised slightly to create an interesting play of shadows on the floor. It comes in any of the matt and oxidized lacquered colour options, colour options, in the clay finish, and in the rovere veneer and noce canaletto finishes.

^{IT} Tavolini Shadows in finitura rovere miele. Composizione a parete con boiserie sp. 2,7 cm in finitura rovere miele e laccato opaco ginepro, mensole Duo e panca sp. 5 cm nella stessa finitura. Pensili e basi Box 18 con gola e frontali Rays in laccato opaco fango. Divano Mac in tessuto Antibes 08 con cuscino in tessuto Afrodite 21 e pouf Loto in tessuto Febe 39.

^{EN} Shadows coffee tables in rovere miele finish. Wall-mounted arrangement with 2,7cm-thick wall panelling in rovere miele and ginepro matt lacquered finishes, Duo shelves and 5cm-thick bench in the same finish. Box 18 wall and base units with profile and Rays fronts in fango matt lacquered finish. Mac sofa in Antibes 08 fabric with cushion in Afrodite 21 fabric and Loto ottoman ottoman in Febe 39 fabric.



Tavolini
Occasional tables

TECHNICAL DATA

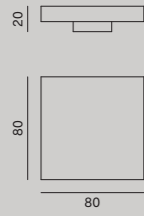

IT Tavolino *Shadows* in finitura argilla lapis. Poltrona *Velvet* in tessuto Callas 40.

EN *Shadows* coffee table in lapis clay finish. Velvet armchair in Callas 40 fabric.

Team

— Design by Studio Gherardi

Rettangolare o quadrato, Team è un tavolino leggero in metallo che per la sua essenzialità si presta agli ambienti più diversi. È disponibile in tutti i colori laccati opachi, ossidati e metal, e reso ancora più prezioso dai piani in finitura noce o olmo termotrattato, impiallacciato di rovere e noce canaletto, argilla o in light stone.

Rectangular or square, Team is a light metal occasional table whose unfussy nature allows it to sit happily in all manner of interiors. It is available in any of the matt, oxidized and metal lacquered colour options, while tops in the noce or olmo termotrattato finish, rovere veneer or noce canaletto, clay or light stone finishes give it an even more luxe feel.



^{IT} Tavolino **Team** con struttura in laccato ossidato brunito e piano in light stone bianco. Tavolino **Team** in laccato ossidato brunito. Poltrona **Artichoke** con rivestimento Eva 11.

^{EN} **Team** occasional table with oxidized bronze lacquered structure and bianco light stone top. **Team** occasional table in oxidized bronze lacquered finish. **Artichoke** armchair upholstered in Eva 11.

IT Tavolino Team con struttura in laccato ossidato brunito e piano in finitura noce canaletto. Tavolino Team con struttura in laccato opaco visone con piano in finitura argilla arena. Letto Park in finitura noce canaletto e tessuto Maya 40.

EN Team occasional table with oxidized bronze lacquered structure and top in noce canaletto finish. Team occasional table with visone matt lacquered structure and top in arena clay finish. Park bed in noce canaletto finish and Maya 40 fabric.



TECHNICAL DATA

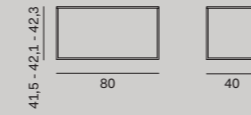

Trio

— Design by Novamobili studio

Proposto in due altezze, il tavolino Trio è un comodo appoggio accanto al divano oppure, se viene collocato vicino al letto, un pratico comodino. Con il piano circolare sorretto da tre gambe, è disponibile in tutti i colori laccati opachi, ossidati e metal.

Available in a choice of two heights, the Trio side table serves as a convenient surface next to the sofa or, placed next to the bed, as a practical nightstand. Featuring a circular top sitting on three legs, it is available in any of the matt, oxidized and metal lacquered colour options.

^{IT} Tavolini Trio in laccato opaco grigio e laguna. Poltrona Origin in tessuto Bonnie 05. Mensole Ellie in laccato ossidato brunito.

^{EN} Trio side tables in grigio and laguna matt lacquered finishes. Origin armchair in Bonnie 05 fabric. Ellie shelves in oxidized bronze lacquered finish.



TECHNICAL DATA



TAVOLINI | OCCASIONAL TABLES

IT Tavolini Trio in laccato metal stagno e in laccato ossidato brunito. Letto Hide in tessuto Sophie 05.

EN Trio occasional tables in tin metal lacquered and oxidized bronze lacquered finishes. Hide bed in Sophie 05 fabric.



Accessori

Accessories



Astrid

— Design by Novamobili studio

Astrid è uno specchio dalla forma circolare di grandi dimensioni, che crea nell'ambiente una piacevole atmosfera calda e sofisticata, grazie anche alla retroilluminazione e al design moderno. Un elemento d'arredo che coniuga perfettamente forma e funzione, arricchendo la parete.

Astrid is a large circular mirror that creates a lovely warm and sophisticated atmosphere in the room, in part thanks to its backlighting and modern design. A decorative piece that is the perfect combination of form and function, for a wall with wow factor.





TECHNICAL DATA

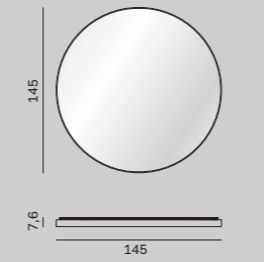

^{IT} Specchio *Astrid* in laccato ossidato brunito con retroilluminazione a LED. Panca *Cube* con vassoio in laccato opaco mogano, gambe in laccato ossidato brunito e cuscino in tessuto Nora 29.

^{EN} *Astrid* mirror in oxidized bronze lacquered finish with LED backlighting. *Cube* bench with mogano matt lacquered tray, legs in oxidized bronze lacquered finish and cushion in Nora 29 fabric.

Deep

Deep è uno specchio dalla forma circolare e disponibile in due diametri. La struttura, anche con illuminazione LED integrata, è disponibile in tutti i colori laccati opachi, ossidati e metal a catalogo, così da abbinarsi perfettamente agli arredi dell'ingresso, del salotto o della camera da letto.

Deep is a circular mirror that comes in two diameters. The structure, which offers the option of built-in LED lighting, is available in any of the matt, oxidized and metal lacquered colours from the catalogue, meaning it pairs beautifully with entry hall, lounge or bedroom furniture.



TECHNICAL DATA

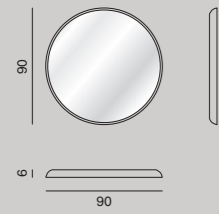
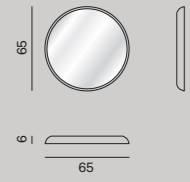

IT Specchi Deep in laccato ossidato bronzo. Madia composta da basi Box 18 in laccato opaco blu notte con basamento Tube in laccato ossidato bronzo.

EN Deep mirrors in oxidized light bronze lacquered finish. Sideboard comprising Box 18 base units in blu notte matt lacquered finish on Tube base in oxidized light bronze lacquered finish.



Flow

— Design by Panciera

Lo specchio Flow è un'icona di raffinatezza. La sua geometria contemporanea aggiunge un tocco di modernità a qualsiasi spazio. La cornice, che è il segno distintivo di questo specchio, inizia con uno spessore sottile per finire a formare un vassoio; è disponibile nelle finiture cuoio. Questo elemento d'arredo illumina e valorizza ogni parete con eleganza.

The Flow mirror is an icon of elegance. Its contemporary geometry adds a touch of the modern to any space. The frame — the distinguishing feature of this mirror — starts off shallow and gradually extends outwards to form a tray; it comes in the leather finishes. This decorative piece brightens and sets off any wall in elegant fashion.

IT Specchio Flow in cuoio finitura scoglio. Madia Fjord in laccato opaco fango con schienale del vano a giorno in finitura rovere carbone e basamento in laccato ossidato brunito. Sedia Agel con struttura in metallo laccato ossidato brunito e in finitura rovere carbone, seduta in tessuto Bonnie 18.

EN Flow mirror with leather trim in scoglio finish. Fjord sideboard in fango matt lacquered finish with open shelf back panel in rovere carbone finish, and oxidized bronze lacquered base. Agel chair with frame in oxidized bronze lacquered metal and rovere carbone finishes, seat in Bonnie 18 fabric.



IT Specchio *Flow* in cuoio finitura cognac. Contenhitori *Square* in finitura rovere miele, telaio in metallo e maniglie in laccato ossidato bronzo, top in light stone breccia medicea.

EN *Flow* mirror with leather trim in cognac finish. *Square* storage units in rovere miele finish, oxidized light bronze lacquered metal frame and handles, breccia medicea light stone top.



TECHNICAL DATA

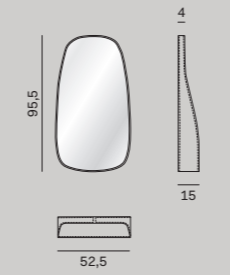
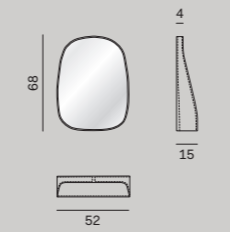
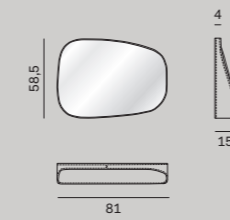

CLOSE-UP

Vista laterale dello specchio *Flow* in cuoio finitura testa di moro. / Side view of *Flow* mirror with leather trim in testa di moro finish.



Odette

— Design by Novamobili studio

Verticale o orizzontale, da appoggio o da parete, lo specchio Odette esprime un gusto semplice e raffinato. La cornice è disponibile nelle finiture noce o olmo termotrattato e in tutti i colori laccati opachi e ossidati.

Vertical or horizontal, set on the floor or mounted on a wall... whatever its situation, the Odette mirror embodies simplicity and refinement. The frame comes in the noce or olmo termotrattato finish, and in any of the matt and oxidized lacquered colour options.

^{IT} Specchio Odette in laccato ossidato bronzo. Tavolino Cliff in laccato ossidato peltro.

^{EN} Odette mirror in oxidized light bronze lacquered finish. Cliff occasional table in oxidized pewter lacquered finish.



TECHNICAL DATA

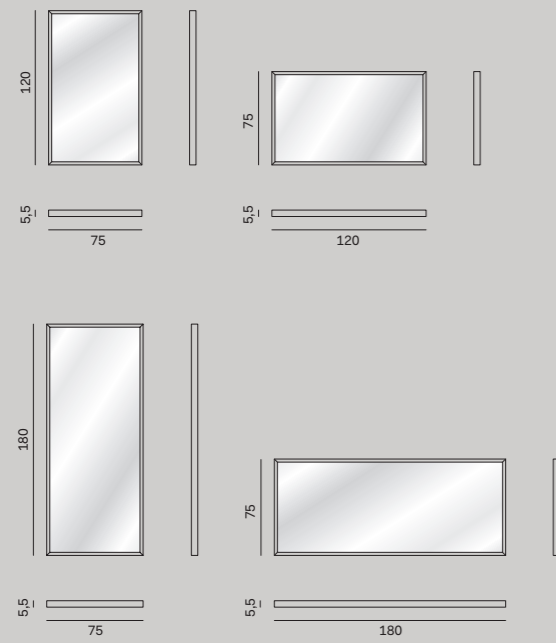

IT Specchio Odette in laccato ossidato bronzo. Panca Dora in tessuto Egle 21 con gambe in finitura noce canaletto.

EN Odette mirror in oxidized light bronze lacquered finish. Dora bench in Egle 21 fabric with legs in noce canaletto finish.

Riga

— Design by e-ggs

Riga è una mensola accessoriata che diventa un elemento funzionale da usare in diversi ambienti della casa. Discreta ed essenziale, la mensola si arricchisce di porta oggetti, specchi e ganci appendiabiti per creare composizioni dalle linee leggere e minimali per l'ingresso, il bagno e ovunque ci sia la necessità di appendere abiti e contenere piccoli oggetti. Ampie le possibilità di personalizzazione: la mensola è disponibile in laccato opaco o ossidato, in impiallacciato di rovere o noce canaletto; scaletta porta oggetti e appendiabiti in laccato opaco, ossidato e metal. Lo specchio ovale è in tre dimensioni.

Riga is an accessorized shelf that turns into a functional unit suited to use in various rooms throughout the home. Low-key and pared-back, the shelf is enhanced with the addition of display shelves, mirrors and coat hooks to create clean-lined and minimalist configurations for the entry hall, bathroom, or anywhere else you need to hang up clothes or find a place for small items. Plenty of scope for customizing: the shelf comes in the matt or oxidized lacquered options, and in the rovere veneer or noce canaletto finishes; the display ladder and coat hooks come in the matt, oxidized and metal lacquered finishes. The oval mirror comes in three sizes.





^{IT} Mensola Riga in laccato opaco foresta con scaletta portaoggetti e ganci appendiabiti in laccato ossidato bronzo e specchio.

^{EN} Riga shelf in foresta matt lacquered finish with oxidized light bronze lacquered display ladder and coat hooks, and mirror.



IT Mensola Riga in laccato opaco
quarzo con ganci appendiabiti
in laccato ossidato brunito e
specchio. Madia composta da basi
Box 18 in finitura rovere miele con
vassoio 3 lati in laccato opaco
quarzo, su basamento Double in
laccato ossidato brunito. Pouf Loto
con rivestimento Eva 20.

EN Riga shelf in quarzo matt
lacquered finish with oxidized
bronze lacquered coat hooks,
and mirror. Sideboard comprising
Box 18 base units in rovere
miele finish with quarzo matt
lacquered 3-sided tray, on
Double base in oxidized bronze
lacquered finish. Loto ottoman
upholstered in Eva 20.



^{IT} Mensola Riga in finitura rovere terra con ganci appendiabiti in laccato metal ottone e specchio. Comò Quarantacinque in finitura rovere terra con top in cuoio finitura testa di moro. Poltrona Origin in tessuto Victoria 06.

^{EN} Riga shelf in rovere terra finish with coat hooks in brass metal lacquered finish, and mirror. Quarantacinque chest of drawers in rovere terra finish with leather top in testa di moro finish. Origin armchair in Victoria 06 fabric.



TECHNICAL DATA

— Conf. 1

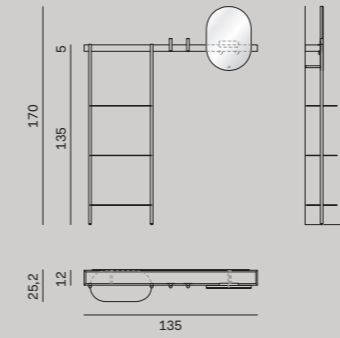

— Conf. 2

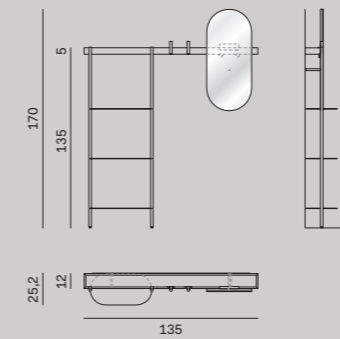

— Conf. 3

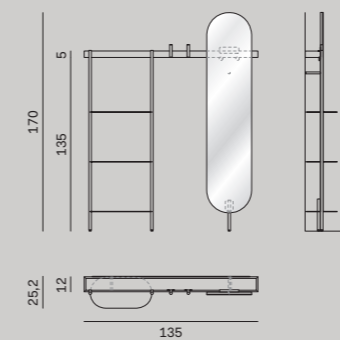

Cube

— Design by e-ggs

Cube è un sistema aperto e flessibile che si compone di panche vassoio e boiserie da attrezzare con pannelli imbottiti, specchi, scrittoi a ribalta, mensole, appendiabiti e tasche portadocumenti. Gli elementi si possono combinare tra loro per creare composizioni funzionali per l'ingresso o la camera da letto, da personalizzare scegliendo tra le molte finiture disponibili, inclusi i tessuti per i pannelli foderati.

Cube is an open, flexible system made up of tray benches and wall panelling to be accessorized with padded panels, mirrors, drop-down desks, shelves, coat hooks and document pouches. The various accessories can be combined to create functional configurations for the entry hall or bedroom, with a whole host of finishes to choose from to tailor the end result, including fabrics for the lined panels.





^{IT} Composizione boiserie **Cube** in finitura olmo termotrattato con modulo specchiera, moduli foderati in tessuto Chloé 18, ganci appendiabiti in laccato metal ottone, tasca in laccato ossidato brunito e scrittoio a ribalta in finitura olmo termotrattato. Panca vassoio **Cube** in finitura olmo termotrattato con cuscino in tessuto Chloé 18 e basamento in laccato metal ottone. Pouf **Loto** in tessuto Chloé 39.

^{EN} **Cube** wall panelling configuration in olmo termotrattato finish with mirror module, modules lined in Chloé 18 fabric, coat hooks in brass metal lacquered finish, oxidized bronze lacquered pouch and drop-down desk in olmo termotrattato finish. **Cube** tray bench in olmo termotrattato finish with cushion in Chloé 18 fabric and base in brass metal lacquered finish. **Loto** ottoman in Chloé 39 fabric.

TECHNICAL DATA

— Conf. 1

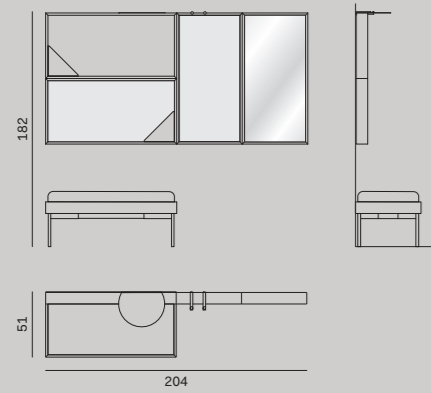

— Conf. 2

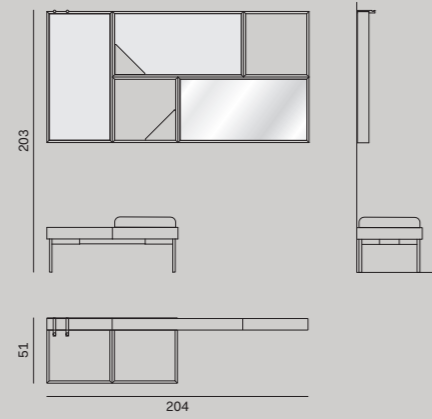

— Conf. 3

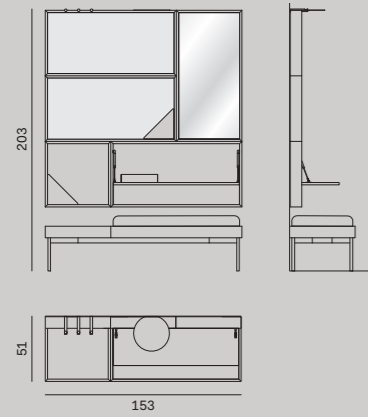

— Conf. 4

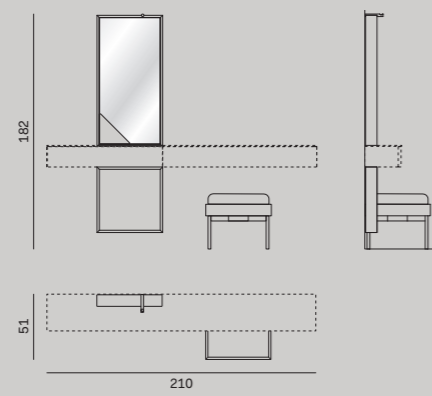

IT Composizione boiserie Cube in laccato opaco visone con tasca e appendiabiti nella medesima finitura e modulo con specchio. Panca vassoio Cube in laccato opaco quarzo, cuscino in tessuto Callas 13 e basamento in laccato ossidato brunito.

EN Cube wall panelling configuration in visone matt lacquered finish with pouch and coat hooks in the same finish, and mirror module. Cube tray bench in quartz matt lacquered finish, cushion in Callas 13 fabric, and oxidized bronze lacquered base.

Desk

— Design by Novamobili studio

Lo scrittoio Desk incarna la fusione tra un design contemporaneo e un distintivo tocco industriale, creando un equilibrio perfetto. La sua forma geometrica e pulita si compone di un piano che si integra armoniosamente con il fianco nella stessa finitura e dalla gamba in metallo con cassetto sottopiano. Ideale per arredare la zona studio o creare un angolo ufficio in casa.

The Desk desk is the epitome of contemporary design blended with a distinctive industrial edge, striking a perfect balance. A top merging harmoniously with a side panel in the same finish, and a metal leg with undermounted drawer combine to give the desk its clean, geometric lines. Ideal for furnishing the study or creating a home office nook.





^{IT} Scrivitoio Desk con piano, fianco e cassetto in finitura rovere grigio e gamba in metallo in laccato opaco fango. Sedia Natt con struttura in laccato opaco ginepro e seduta in tessuto Laila 54.

^{EN} Desk desk with top, side and drawer in rovere grigio finish, and fango matt lacquered metal leg. Natt chair with ginepro matt lacquered frame and seat in Laila 54 fabric.



^{IT} Scrivania Desk con piano e fianco in finitura noce canaletto, cassetto con frontale Rays e gamba in metallo in laccato ossidato bronzo. Pensili con ante Era in laccato opaco tortora e in vetro fumé, telaio in laccato opaco tortora. Pouf Loto in tessuto Iris 54.

^{EN} Desk desk with top and side in noce canaletto finish, drawer with Rays front and metal leg in oxidized light bronze lacquered finish. Wall-mounted units with Era doors in tortora matt lacquered finish and smoked glass, tortora matt lacquered frame. Loto ottoman in Iris 54 fabric.



TECHNICAL DATA

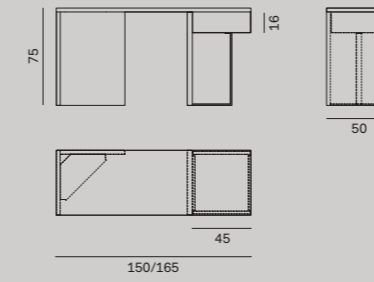

Knot

— Design by Ferriani e Sbolgi

Lo scrittoio Knot è ispirato al design nordico. La sua linea arrotondata si distingue per l'eleganza senza tempo. Accessori funzionali come il portadocumenti e il sottomano, aggiungono una nota di funzionalità senza compromettere l'estetica. Knot arricchisce lo spazio con un tocco unico e raffinato.

The Knot desk takes its inspiration from Nordic design. Its rounded line stands out for its timeless elegance. Functional accessories like the document pouch and desk pad add a functional edge without compromising aesthetics. Knot graces the space with a unique, stylish touch.

^{IT} Scrittoio Knot in finitura noce canaletto con accessori in cuoio finitura testa di moro. Pouf Log in tessuto Laila 05.

^{EN} Knot desk in noce canaletto finish with leather accessories in testa di moro finish. Log ottoman in Laila 05 fabric.



IT Dettaglio del portadocumenti in
cuoio finitura testa di moro.

EN Detail of leather document
pouch in testa di moro finish.



TECHNICAL DATA

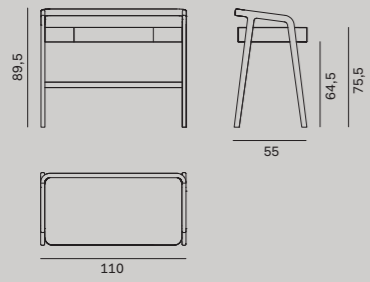

Ninfea

— Design by Zanellato/Bortotto

Ninfea è uno scrittoio dalle forme semplici ed eleganti. Sottili gambe metalliche supportano un piano dalle forme morbide e arrotondate. Il séparé, in tessuto, può essere usato come piccola bacheca su cui appendere appunti e documenti con calamite attratte dall'anima metallica. Lo scrittoio, con pratico cassetto sottopiano, è ideale per ricreare un angolo lettura in camera da letto e si configura anche come toeletta, grazie alla scatola in legno portaoggetti e allo specchio circolare.

Ninfea is a desk with simple, elegant lines. A top with soft, rounded shapes sits on slender metal legs. The privacy screen, in fabric, doubles as a little noticeboard for posting notes and documents on using magnets attracted to its metal inner. The desk, which has a handy undermounted drawer, is ideal for recreating a reading nook in the bedroom, and also has a dressing table-esque setup with its wooden caddy and circular mirror.





^{IT} Scrivania **Ninfea** con separ  in tessuto Antibes 05, specchio, piano in finitura rovere carbone, cassetto e scatola portaoggetti in laccato opaco blu notte, gambe in laccato ossidato brunito. Sedia **Rose** con struttura in finitura rovere carbone e seduta con rivestimento Eva 11.

^{EN} **Ninfea** desk with privacy screen in Antibes 05 fabric, mirror, top in rovere carbone finish, drawer and caddy in blu notte matt lacquered finish, oxidized bronze lacquered legs. **Rose** chair with frame in rovere carbone finish and seat upholstered in Eva 11.

IT Scrivania **Ninfea** con separè in tessuto Sophie 45, piano e cassetto in laccato opaco piombo e gambe in laccato ossidato brunito. Pouf **Log** in tessuto Gaia 05.

EN **Ninfea** desk with privacy screen in Sophie 45 fabric, top and drawer in piombo matt lacquered finish, and oxidized bronze lacquered legs. **Log** ottoman in Gaia 05 fabric.



TECHNICAL DATA

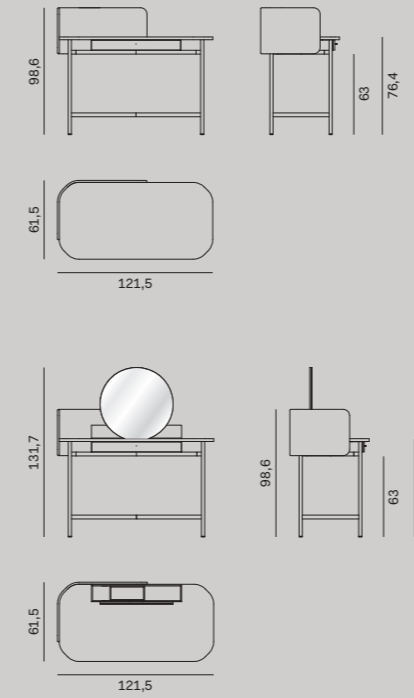

Shy

— Design by Federica Biasi

Il paravento Shy rappresenta un'elegante fusione tra estetica e funzionalità. Il pannello rivestito in tessuto dona un tocco di raffinatezza, mentre la struttura e i ganci in laccato ossidato brunito si adattano perfettamente a ogni progetto. Accessoriabile con ganci appendiabiti, vassoio e specchio, Shy completa l'arredo della zona living, creando una pratica zona guardaroba. In camera da letto, può essere utilizzato per suddividere lo spazio, donando un'estetica ricercata alla stanza.

The Shy privacy screen is an elegant blend of looks and function. The fabric-covered panel injects a touch of elegance, while the oxidized bronze lacquered frame and hooks blend perfectly with any decor. With accessories like coat hooks, trays and mirrors to choose from, Shy adds the finishing touch to the living area, creating a practical spot for removing outerwear. In the bedroom, it can be used to divide up the space, giving the room a stylish look.



IT Paravento Shy in tessuto Aura 11 con telaio e gancio appendiabiti in laccato ossidato brunito, vassoio in finitura rovere carbone e specchio. Poltrona Reef in tessuto Callas 57. Tavolino Orbis in laccato ossidato brunito e piano in light stone bianco.

EN Shy privacy screen in Aura 11 fabric with oxidized bronze lacquered frame and coat hook, tray in rovere carbone finish, and mirror. Reef armchair in Callas 57 fabric. Orbis occasional table in oxidized bronze lacquered finish with bianco light stone top.



TECHNICAL DATA

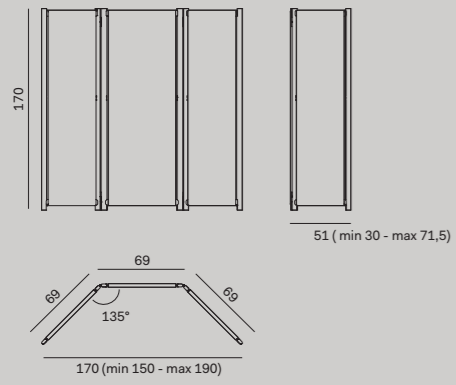

IT Paravento *Shy* in tessuto Nora 17 con telaio e ganci appendiabiti in laccato ossidato brunito, vassoio in finitura rovere chiaro e specchio. Tavolino *Circle* in laccato opaco grigio.

EN *Shy* privacy screen in Nora 17 fabric with oxidized bronze lacquered frame and coat hooks, tray in rovere chiaro finish, and mirror. *Circle* side table in grigio matt lacquered finish.



Jupiter

— Design by Ferriani e Sbolgi

Il servomuto Jupiter, disponibile nelle finiture rovere carbone e rovere chiaro, si distingue per la sua versatilità e lo stile moderno. Con il comodo vassoio e il tubo appendiabiti, Jupiter offre un'organizzazione intelligente degli spazi, arricchendo con eleganza e funzionalità i diversi ambienti della casa.

The Jupiter valet stand — which comes in the rovere carbone and rovere chiaro finishes — stands out for its versatility and modern style. With the handy tray and hanging rail, Jupiter is a smart space organizer, making an elegant and functional addition to enhance rooms throughout the home.



DETAILS COLLECTION

^{IT} Servomuto Jupiter in finitura rovere carbone. Pouf Log in tessuto Sophie 45. Armadio anta scorrevole Picture in laccato opaco fango con maniglia in laccato ossidato brunito.

^{EN} Jupiter valet stand in rovere carbone finish. Log ottoman in Sophie 45 fabric. Picture sliding door wardrobe in fango matt lacquered finish with oxidized bronze lacquered handle.



ACCESSORI | ACCESSORIES

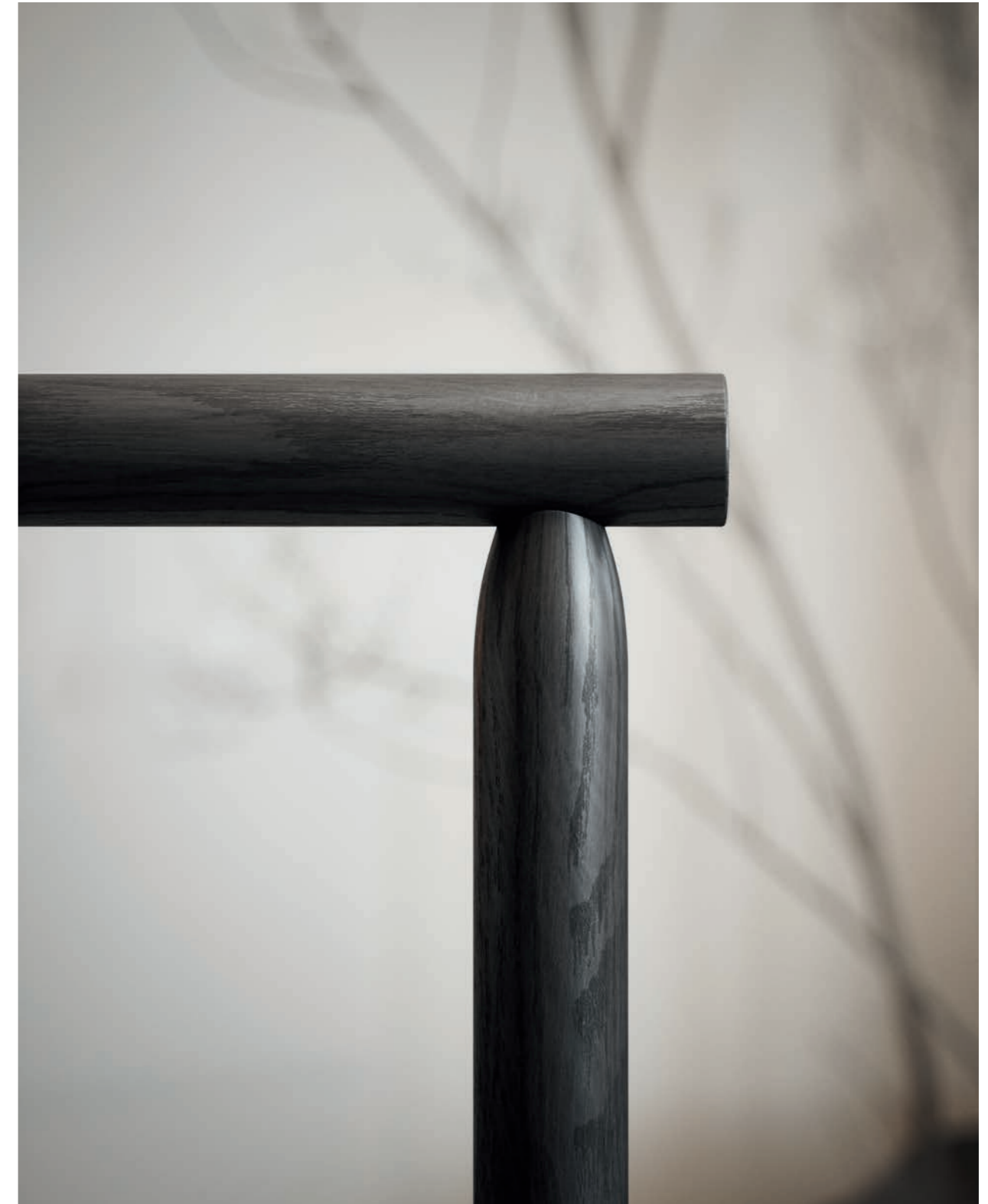

IT Servomuto Jupiter in finitura rovere chiaro.

EN Jupiter valet stand in rovere chiaro finish.



TECHNICAL DATA

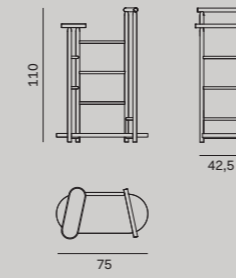

Freebook

— Design by Tormena Neadesign

Freebook è una libreria composta da cubi in metallo sovrapponibili e multidirezionali, capaci di colorare e personalizzare gli ambienti domestici. In versione a uno, due e tre moduli, Freebook si presta a essere usata anche come tavolino accanto a poltrone e divani. È disponibile in tutti i colori laccati opachi, ossidati e metal.

Freebook is a bookcase made up of multi-directional metal cubes that can be stacked on top of each other, injecting colour and individuality into home interiors. Available as a single-, double- or three-module unit, Freebook also lends itself to use as a side table next to armchairs and sofas. It comes in any of the matt, oxidized and metal lacquered colour options.

^{IT} Librerie Freebook in laccato opaco bianco e foglia. Sedia Natt con struttura in laccato opaco cenere e seduta in tessuto Victoria 06.

^{EN} Freebook bookcases in bianco and foglia matt lacquered finishes. Natt chair with cenere matt lacquered frame and seat in Victoria 06 fabric.



TECHNICAL DATA

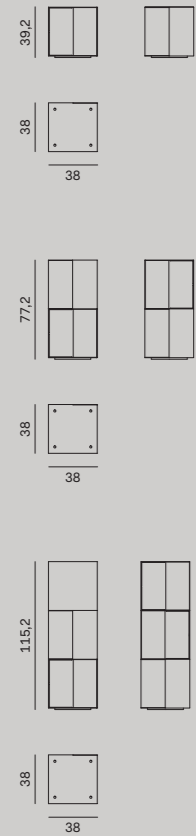

^{IT} Libreria **Freebook** in laccato ossidato bronzo. Divano **Reef** in tessuto Laila 05. Libreria **Wall 12** in finitura bianco seta.

^{EN} **Freebook** bookcase in oxidized light bronze lacquered finish. **Reef** sofa in Laila 05 fabric. **Wall 12** bookcase in bianco seta finish.



Finiture e
materiali

*Finishes and
materials*

DETAILS COLLECTION

Laccato opaco
all'acqua
*Water-based
matt
lacquered*



300 bianco 303 tortora 333 sabbia 310 quarzo 331 visone 351 magnolia 318 nero grafite



341 cenere 330 grigio 352 piombo 353 blu notte 362 laguna 355 ginepro 324 fango 354 tiglio



346 foresta 342 foglia 314 corda 359 ambra 360 cotto 361 mogano 358 castagna

Rays



Laccato opaco in tutte le finiture |
Matt lacquered in all finishes

FINITURE | FINISHES

Laccato lucido
*Gloss
lacquered*



400 bianco 403 tortora 433 sabbia 410 quarzo 451 magnolia 418 nero grafite 441 cenere



430 grigio 452 piombo 453 blu notte 462 laguna 455 ginepro 414 corda 459 ambra 460 cotto



461 mogano 458 castagna

Laccato ossidato
*Oxidized
lacquered*



306 brunito | bronze 304 bronzo | light bronze 305 peltro | pewter

Laccato metal
*Metal
lacquered*



307 rame | copper 308 ottone | brass 309 brown 302 stagno | tin

Rays



Laccato ossidato in tutte le finiture |
Oxidized lacquered in all finishes

DETAILS COLLECTION

Ecolegno
Eco-wood



72
noce

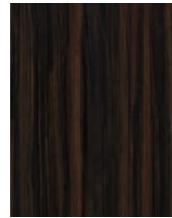

73
olmo
termotrattato

Impiallacciato
Veneers

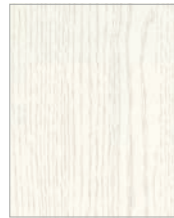

N07
rovere bianco



N04
rovere chiaro



N02
rovere miele



N01
rovere terra



N06
rovere grigio

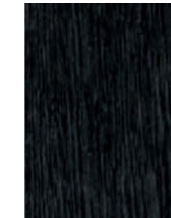

N05
rovere carbone

Rays



Impiallacciato in tutte le finiture |
Veneers in all finishes

Noce
canaletto



N03
noce canaletto

Rays



N03
noce canaletto

Argilla
Clay

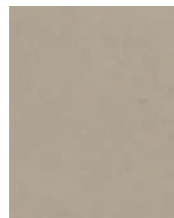

A04
pomice



A03
arena



A02
fumo

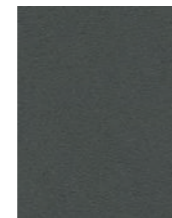

A05
lapis

FINITURE | FINISHES

Marmo
Marble



MM1
bianco Carrara
lucido | *polished*

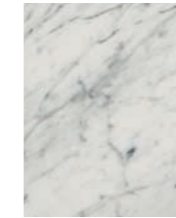

MM2
bianco Carrara
opaco | *matt*

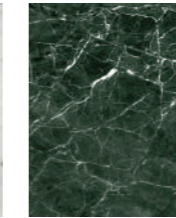

MM5
verde Guatemala
lucido | *polished*

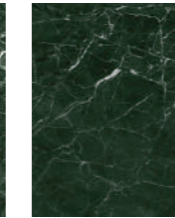

MM6
verde Guatemala
opaco | *matt*

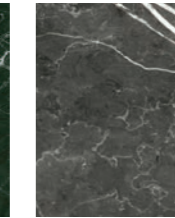

MM3
grigio Oriente
lucido | *polished*

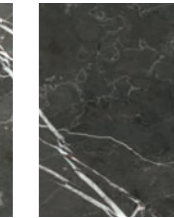

MM4
grigio Oriente
opaco | *matt*

Light stone



R01
bianco



R03
calacatta grey

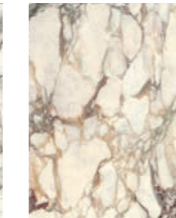

R05
breccia medicea

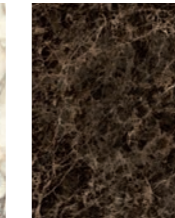

R06
emperador

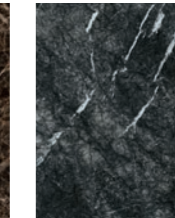

R04
grigio alpi carnia

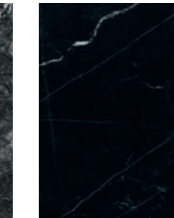

R02
nero

Pietra lavica
Lava stone

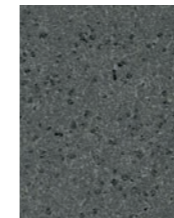

MM7
opaca |
matt



MM8
nera opaca |
matt black

Cuoio
Leather



03W
cognac

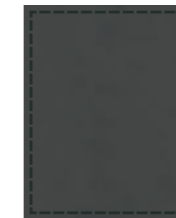

03X
scoglio



03T
testa di moro

Vetro temprato
standard
Standard
toughened
glass



C08
trasparente |
transparent



C80
fumé | *smoked*

Vetro temprato
plus
Plus
toughened
glass



C81
stop-sol



C02
cannettato |
reeded

Indice
prodotti

*Product
index*

Accessori | Accessories

ASTRID p. 254
CUBE p. 254, 279, 281
DEEP p. 86, 259
DESK p. 285, 286
FLOW p. 261, 262, 263
FREEBOOK p. 313, 315
JUPITER p. 308, 310
KNOT p. 289
NINFEA p. 297, 298
ODETTE p. 265, 267
RIGA p. 127, 271, 272, 274
SHY p. 302, 305

Armadio anta scorrevole | Sliding door wardrobe

PICTURE p. 308

Cabine armadio | Walk-in closets

BREAK p. 129

Contenitori | Storage units

BOX 12 p. 23
BOX 18 p. 11, 19, 20, 28, 44, 52, 59, 86, 94, 101, 214, 239, 259, 272
HUB p. 69
OUTLINE p. 19, 20, 44, 101, 221
TETRIS p. 52

Contenitori notte | Bedroom storage units

QUARANTACINQUE p. 274
SQUARE p. 262

Divani | Sofas

AVENUE p. 233
BLOSSOM p. 203
MAC p. 216, 225, 235, 236, 239
NOA p. 195, 214, 221
REEF p. 185, 315

Letti | Beds

BRICK p. 206
HIDE p. 198, 249
PARK p. 244

Librerie | Bookcases

BUTTERFLY p. 227
PONTILE p. 19, 27, 75, 187
WALL 12 p. 12, 205, 315
WALL 30 p. 118, 166, 174, 214

Madie | Sideboards

BAY p. 121, 137, 139
BELT p. 35, 143, 145, 146, 147, 148
CLEO p. 50, 153, 155
FJORD p. 114, 158, 160, 162, 163, 261
FLOAT p. 60, 166, 169
REVERSE p. 36, 172, 174
SHADOWS p. 179, 181
STRIPE p. 43, 185, 187, 188

Mensole | Shelves

DUO p. 239
ELLIE p. 109, 113, 145, 231, 247

Poltrone | Armchairs

ARTICHOKE p. 139, 160, 214, 243
BLOSSOM p. 169
HAIKU p. 166, 187
HAMPTONS p. 137
ORIGIN p. 20, 235, 247, 274
REEF p. 205, 211, 302
VELVET p. 209, 241

Pouf | Ottomans

AVENUE p. 223
BLOSSOM p. 148, 227
LOG p. 14, 27, 28, 30, 39, 104, 113, 123, 137, 139, 162, 174, 231, 236, 289, 298, 308
LOTO p. 12, 35, 44, 50, 52, 60, 75, 145, 146, 188, 221, 239, 272, 279, 286

Sedute | Seating

AGEL p. 69, 70, 71, 261
CANDY p. 36, 62, 75, 76
CHURCH p. 125, 127
DORA p. 129, 130, 267
ELLEN p. 80, 83
NATT p. 14, 27, 86, 88, 285, 313
NAVY p. 28, 59, 94, 97
NAVY TUB p. 12, 35, 93, 172
ROSE p. 11, 19, 43, 101, 102, 104, 105, 143, 297
TIME p. 23, 44, 52, 60, 109, 111, 153
TWIST p. 20, 39, 50, 113, 114, 117, 118
YOKO p. 121, 122, 123

Tavoli | Tables

FILO p. 11, 12, 14, 15, 104, 109, 113, 123
HANAMI p. 19, 20, 22, 23, 101, 102, 121, 123, 143
LEVEL p. 27, 28, 30, 31, 69, 80
REA p. 35, 36, 38, 39, 80, 88, 97
STRETCH p. 43, 44, 47
SUNNY p. 50, 52, 54, 55, 71, 93, 153
TORII p. 59, 60, 62, 63, 94

Tavolini | Occasional tables

ALICE p. 195
ALLOUT p. 198
BALANCE p. 202, 203
CIRCLE p. 50, 127, 130, 205, 206, 305
CLIFF p. 209, 211, 265
FLY p. 166, 214, 216
GLOBE p. 114, 146, 221, 223
KIN p. 225, 227
ORBIS p. 231, 232, 233, 302
SEVEN p. 235, 236, 237
SHADOWS p. 239, 241
TEAM p. 243, 244
TRIO p. 83, 160, 162, 174, 247, 249

Concept and creative direction

Valeria Carlesso

Project and set design

Novamobili studio

Print layout

grucciadesign.

Digital images

Helios Digital

Photography

Studio Emozioni

Beppe Brancato (pp: 102, 103, 141/143, 183/185)

Styling

Loop Lab

Elena Caponi Studio (pp: 141/143, 183/185)

Colour separation

Lucegroup

Print

Antezza Tipografi

January 2024

^{IT} Novamobili si riserva in qualsiasi momento la facoltà di apportare tutte le modifiche necessarie al miglioramento funzionale e qualitativo dei propri prodotti. Per ogni aspetto tecnico e dimensionale fare riferimento ai listini aziendali e relativi aggiornamenti. I colori e i materiali riprodotti nelle immagini stampate hanno un valore indicativo. Novamobili declina ogni responsabilità derivante da eventuali inesattezze di stampa e/o da errori sulle caratteristiche dei prodotti forniti.

^{EN} In line with its policy of improving product function and quality, Novamobili reserves the right to make any necessary changes at any time. For information of a technical and dimensional nature, refer to the company price lists and relevant updates. The colours and materials reproduced in the images printed herein are given as an approximate guide only. Novamobili does not accept any responsibility for misprints and/or mistakes in describing the characteristics of the products supplied.

NOVAMOBILI

Novamobili Spa
via G.Pascoli 14
31053 Pieve di Soligo
Treviso – Italia
T +39 0438 98 68
F +39 0438 98 6999
novamobili@novamobili.it



Battistella
company



The mark of
responsible forestry

^{IT} Richiedi a info@novamobili.it se
il prodotto a cui sei interessato è
certificato FSC®.

^{EN} Ask info@novamobili.it if the
product you are interested in is
FSC® certified.

HOME SYSTEM
DAILY INSPIRED

novamobili.it