

A modern living room with a large window, a grey sofa, and a fireplace. The room features a large window with a black frame, offering a view of a lush garden with green plants and trees. A grey sofa is positioned in front of the window, and a dark, curved fireplace is visible on the right. The floor is covered in a dark, textured carpet with a marbled pattern. The overall atmosphere is bright and airy, with natural light streaming in from the window.

CORETECH

Architectural design

FLORIM



“Guardiamo al business come una forza positiva in grado di generare profitto e allo stesso tempo creare un impatto virtuoso sulle persone e sull’ambiente. Da sempre.

Le nostre scelte, giorno dopo giorno, ci hanno portato a migliorare il nostro modo di fare impresa.”

“We conceive the business as a positive force able to generate profits and at the same time create a virtuous impact on people and the environment. Since forever.

Our choices, day after day, have led us to improve our way of doing business.”

Ci siamo misurati con **alti standard di performance sociale e ambientale** e dopo un lungo e rigoroso processo di verifica **siamo diventati B Corp.**

We vied with **high social and environmental performance standards**, and after a long and scrupulous verification process, we became a B Corp certified company.

Le B Corp costituiscono un movimento globale di ‘Purpose Driven Businesses’ che ha l’obiettivo di diffondere un **nuovo paradigma economico**, che vede le imprese come protagoniste nella diffusione di modelli di business per un’economia più equa e inclusiva.

B Corps constitute a global movement of ‘Purpose Driven Businesses’ with the goal of spreading a **new economic paradigm**, where companies play a leading role in promoting business models for a fairer and more inclusive economy.



Scopri di più:
Find out more:



Siamo orgogliosi di far parte di un **cambiamento culturale epocale** e rientrare tra il 3% delle imprese che sono riuscite a raggiungere la certificazione.

We are proud to be part of an **epochal cultural change** and to belong to the 3% of companies that have successfully achieved certification.

Il nostro risultato non è altro che la conseguenza di molteplici attività compiute negli anni passati: dal 2008 redigiamo il **Bilancio di Sostenibilità** e il 19 marzo 2020 siamo diventati **Società Benefit**, formalizzando il nostro impegno a migliorare l’impatto positivo sulla società e sull’ambiente.

Our result is nothing more than the consequence of multiple activities carried out in past years: since 2008, we have prepared the **Sustainability Report**, and on March 19, 2020, we became a **Benefit Corporation**, formalizing our commitment to improving our positive impact on society and the environment.



Sono le superfici Climate Positive di Florim che vanno **oltre l’impatto zero** perché compensano più CO₂ di quella emessa durante il loro ciclo di vita.

Florim’s Climate Positive surfaces **go beyond zero impact** because they offset more CO₂ than is emitted during their lifecycle.



Misuriamo l’impatto ambientale delle nostre superfici, dalle materie prime allo smaltimento.

We measure the environmental impact of our surfaces, from raw materials to disposal.

Riduciamo l’uso di risorse naturali e abbattiamo le nostre emissioni grazie a un processo produttivo più sostenibile: fino al 100% in termini di acqua, energia elettrica e recupero degli scarti.

We reduce the use of natural resources and lower our emissions through a manufacturing process that is more sustainable: up to 100% in terms of water, electricity, and waste recovery.

Creiamo collezioni climate positive compensando il 10% in più della CO₂ emessa durante il loro ciclo di vita.

We create climate positive collections by offsetting 10% more of the CO₂ emitted throughout the collections’ life cycle.



Scopri di più:
Find out more:



Architectural design

Materiale tecnico seguendo le tendenze dell'architettura, per applicazioni quali pavimentazioni industriali e realizzazioni pubbliche a medio e ad alto traffico, come aeroporti, centri commerciali, ristoranti, uffici, negozi, ma anche applicazioni residenziali con un mirato contenuto estetico.

Technical material in line with architectural trends, for applications such as industrial flooring and public buildings with medium to high footfall, such as airports, shopping centres, restaurants, offices, shops, as well as residential applications featuring a targeted aesthetic content.

Matériau technique suivant les tendances de l'architecture, pour des applications en tant que sols industriels et des réalisations publiques à trafic moyen et intense, comme les aéroports, les centres commerciaux, les restaurants, les bureaux, les magasins, mais aussi pour des applications résidentielles au contenu esthétique ciblé.

Technisches Material im Einklang mit den architektonischen Trends für Anwendungen wie Industrieböden und mittelhoch bis stark frequentierte öffentliche Bereiche wie Flughäfen, Einkaufszentren, Restaurants, Büros und Läden, aber auch für Wohngebäude mit wertiger Optik.

Material técnico que sigue las tendencias de la arquitectura, creado para pavimentos industriales y ambientes públicos de mediano y alto tránsito —como aeropuertos, centros comerciales, restaurantes, oficinas y tiendas—, pero también para aplicaciones residenciales con un refinado contenido estético.

performance



appeal



project



ecobuilding



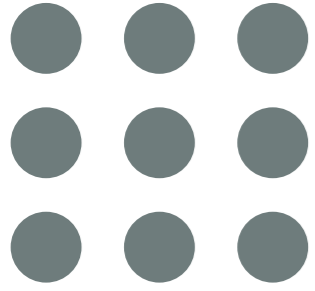

CORETECH

Architectural design

CORETECH



Coretech è la collezione di Florim che rende la pietra piacentina, estratta nel cuore delle Prealpi Giulie, ancora più performante per le esigenze dell'architettura contemporanea. Ispirata ad un materiale naturalmente bello, resistente, durabile e lavorabile, Coretech si spinge oltre, per assicurare un approccio sostenibile al costruire.



CORETECH

Florim's **Coretech** collection takes Piasentina stone quarried in the foothills of the Julian Alps and enhances its performance to cater to the needs of contemporary architecture. Inspired by a naturally beautiful, tough and workable yet durable material, Coretech takes things to the next level, ensuring a sustainable approach to construction.

Coretech est la collection de Florim qui rend la pierre Piasentina, extraite au cœur des Préalpes juliennes, encore plus adaptée aux besoins de l'architecture contemporaine. Inspirée d'un matériau naturellement beau, résistant, durable et facile à travailler, Coretech va encore plus loin afin de garantir une approche durable de la construction.

Coretech ist die Kollektion von Florim, mit der Pietra Piasentina, der im Herzen der Julischen Voralpen gewonnen wird, noch mehr Leistungsfähigkeit erhält und somit den Anforderungen der zeitgenössischen Architektur bestens gerecht wird. Coretech geht, von diesem natürlich schönen, widerstandsfähigen, haltbaren und verarbeitbaren Material inspiriert, noch ein Stück weiter, um der Baubranche einen nachhaltigen Ansatz zu bieten.

Coretech es la colección de Florim que logra que la piedra Piasentina, extraída en el corazón de los Prealpes Julianos, ofrezca un mejor rendimiento para las necesidades de la arquitectura contemporánea. La colección Coretech, inspirada en un material hermoso por naturaleza, resistente, duradero y fácil de trabajar, va más allá para garantizar un enfoque sostenible en la construcción.





floor: flame dark matte 120x240 47 1/4"x94 1/2"
flame light R+PTV 120x120 47 1/4"x47 1/2"

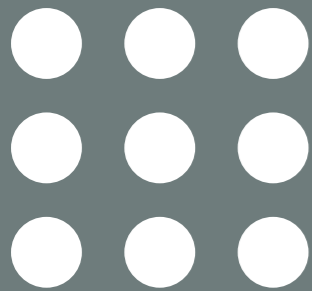









floor: flame dark matte 120x240 47^{1/2}"x94^{1/2}"
flame light R+PTV 120x120 47^{1/4}"x47^{1/4}"

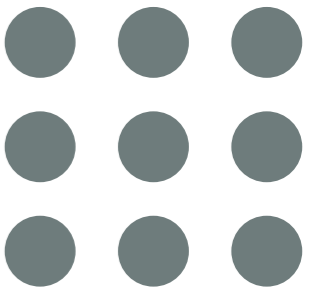







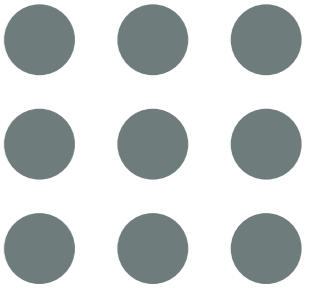



floor: flame dark matte 120x240 47^{1/4}"x94^{1/2}"
flame light R+PTV 120x120 47^{1/4}"x47^{1/4}"







floor: flame dark matte 120x240 47^{1/4}"x94^{1/2}"
flame light R+PTV 120x120 47^{1/4}"x47^{1/4}"



floor: flame dark matte 120x240 47^{1/2}"x94^{1/2}"
flame light R+PTV 120x120 47^{1/2}"x47^{1/2}"







kitchen island: satin dark soft
floor: flame dark matte 120x240 47^{1/4} x 94^{1/2}"







wall: flame light canneté 60x120 23^{5/8}"x47^{1/4}"
floor: flame light matte 120x240 47^{1/4}"x94^{1/2}"

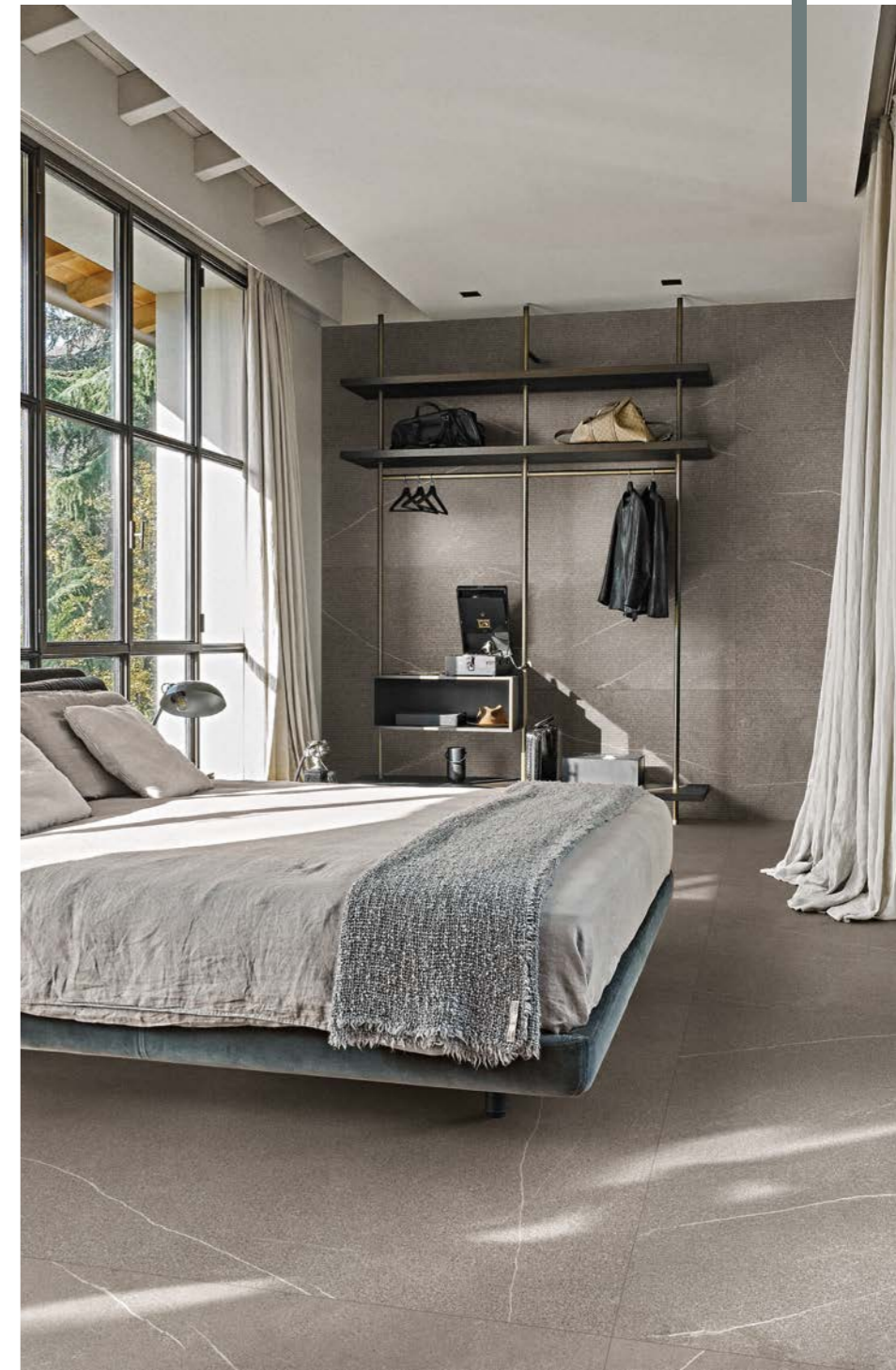
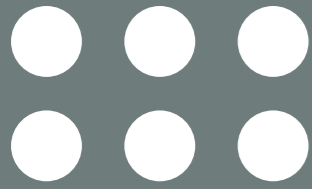

wall: flame light canneté 60x120 23^{5/8}"x47^{1/4}"
floor: flame light matte 120x240 47^{1/4}"x94^{1/2}"



wall: brushed light matte 120x280 47^{1/4}"x110^{1/4}"



wall: flame light matte 120x280 47^{1/4}"x110^{1/4}" flame light cannetè 60x120 23^{5/8}"x47^{1/4}"
floor: flame light R+PTV 120x120 47^{1/4}"x47^{1/4}"



FLAME LIGHT

GRES FINE PORCELLANATO
 FINE PORCELAIN STONEWARE / GRÈS CÉRAME FIN / FEINSTEINZEUG-KOLLEKTIONEN / GRES PORCELÁNICO FINO
 SQUADRATO - SQUARED - EQUARRI - REKTIFIZIERT - ESCUADRADO

9 mm 3/8" ↓	COLOR	SURFACE	120x120 47 1/4" x 47 1/4"	80x180 31 1/2" x 70 5/7"	60x120 23 5/8" x 47 1/4"	60x60 23 5/8" x 23 5/8"
CORETECH	FLAME LIGHT	NATURALE/MATTE	-	778943	778947	779227
		R+PTV	779553	-	779555	-
		CANNETÉ	-	-	778953	-

6 mm 1/4" ↓	COLOR	SURFACE	120x280 47 1/4" x 110 1/4"	120x240 47 1/4" x 94 1/2"	120x120 47 1/4" x 47 1/4"	60x120 23 5/8" x 47 1/4"
CORETECH	FLAME LIGHT	NATURALE/MATTE	778907	778911	778915	778919



BRUSHED LIGHT

GRES FINE PORCELLANATO
 FINE PORCELAIN STONEWARE / GRÈS CÉRAME FIN / FEINSTEINZEUG-KOLLEKTIONEN / GRES PORCELÁNICO FINO
 SQUADRATO - SQUARED - EQUARRI - REKTIFIZIERT - ESCUADRADO

9 mm 3/8" ↓	COLOR	SURFACE	80x180 31 1/2" x 70 5/7"	60x120 23 5/8" x 47 1/4"	60x60 23 5/8" x 23 5/8"
CORETECH	BRUSHED LIGHT	NATURALE/MATTE	778944	778948	779228

6 mm 1/4" ↓	COLOR	SURFACE	120x280 47 1/4" x 110 1/4"	120x240 47 1/4" x 94 1/2"	120x120 47 1/4" x 47 1/4"	60x120 23 5/8" x 47 1/4"
CORETECH	BRUSHED LIGHT	NATURALE/MATTE	778908	778912	778916	778920





SATIN DARK

GRES FINE PORCELLANATO
 FINE PORCELAIN STONEWARE / GRÈS CÉRAMÉ FIN / FEINSTEINZEUG-KOLLEKTIONEN / GRES PORCELÁNICO FINO
 SQUADRATO - SQUARED - EQUARRI - REKTIFIZIERT - ESQUADRADO

9 mm 3/8" ↓	COLOR	SURFACE	80x180 31 1/2"x70 5/7"	60x120 23 5/8"x47 1/4"	60x60 23 5/8"x23 5/8"
CORETECH	SATIN DARK	SOFT	778941	778945	779225

6 mm 1/4" ↓	FLORIN OVERSIZE magnum	COLOR	SURFACE	120x280 47 1/4"x110 1/4"	120x240 47 1/4"x94 1/2"	120x120 47 1/4"x47 1/4"	60x120 23 5/8"x47 1/4"
CORETECH		SATIN DARK	SOFT	778905	778909	778913	778917



FLAME DARK

GRES FINE PORCELLANATO
 FINE PORCELAIN STONEWARE / GRÈS CÉRAMÉ FIN / FEINSTEINZEUG-KOLLEKTIONEN / GRES PORCELÁNICO FINO
 SQUADRATO - SQUARED - EQUARRI - REKTIFIZIERT - ESQUADRADO

9 mm 3/8" ↓	COLOR	SURFACE	120x120 47 1/4"x47 1/4"	80x180 31 1/2"x70 5/7"	60x120 23 5/8"x47 1/4"	60x60 23 5/8"x23 5/8"
CORETECH	FLAME DARK	NATURALE/MATTE	-	778942	778946	779226
		R+PTV	779552	-	779554	-

6 mm 1/4" ↓	FLORIN OVERSIZE magnum	COLOR	SURFACE	120x280 47 1/4"x110 1/4"	120x240 47 1/4"x94 1/2"	120x120 47 1/4"x47 1/4"	60x120 23 5/8"x47 1/4"
CORETECH		FLAME DARK	NATURALE/MATTE	778906	778910	778914	778918



GRES FINE PORCELLANATO
 FINE PORCELAIN STONEWARE / GRÈS CÉRAME FIN / FEINSTEINZEUG-KOLLEKTIONEN / GRES PORCELÁNICO FINO
 SQUADRATO - SQUARED - EQUARRI - REKTIFIZIERT - ESCUADRADO

PEZZI SPECIALI/SPECIAL TRIMS/PIÈCES SPÉCIALES/FORMSTÜCKE/PIEZAS ESPECIALES

9 mm 3/8" ↓		COLOR	SURFACE	4,6x120 1 ^{45/64} "x47 ^{1/4"} battiscopa	33x120x3 13"x47 ^{1/4"} x1 ^{1/8"} gradino
CORETECH		FLAME LIGHT	NATURALE/MATTE	779586	779049
		BRUSHED LIGHT	NATURALE/MATTE	779585	779047
		SATIN DARK	SOFT	779588	779050
		FLAME DARK	NATURALE/MATTE	779587	779048



In relazione alle differenti tecnologie produttive l'accostamento di prodotti con spessori diversi potrebbe presentare delle disomogeneità, se ne sconsiglia pertanto l'abbinamento.
 Due to the different production technologies, contiguous installation of products with different thickness may give a non-homogeneous result. For this reason we do not recommend this option. / Vu que différentes technologies de production sont utilisées avec des épaisseurs différentes, des problèmes d'homogénéité pourraient se présenter, il est donc déconseillé de les poser ensemble. / Wegen unterschiedlicher Produktionstechnologien können die Fliesen mit verschiedenen Materialstärken optische Differenzen aufweisen. Von einem direkten Aneinanderlegen wird deshalb abgeraten. / Debido a las diferentes tecnologías productivas, la combinación de productos de diferentes espesores podría dar lugar a heterogeneidad, por lo que se desaconseja mezclarlas.

CORETECH OUTDOOR

Vantaggi tecnici - Technical advantages - Avantages techniques Technische Vorteile - Ventajas técnicas

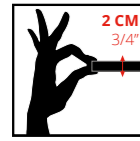

- Lastra monolitica compatta di spessore 2 cm squadrata e rettificata
- Compact monolithic slab 2 cm thick squared and rectified
- Dalle monolithique compacte de 2 cm d'épaisseur, équarrie et rectifiée
- Kompakte monolithische Platte, 2 cm dick, rechteckig und scharfkantig geschliffen
- Losa monolítica compacta de 2 cm de espesor, escuadrada y rectificada.

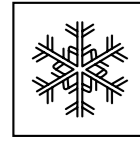

- INGELIVO
- FROST RESISTANT
- INGÉLIF
- FROSTBESTÄNDIG
- RESISTENTE A LA HELADA

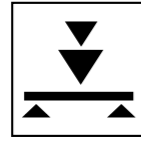

- ELEVATA RESISTENZA AI CARICHI STATICI
- HIGH STATIC LOAD RESISTANCE
- RÉSISTANCE ÉLEVÉE AUX CHARGES STATIQUES
- HOHE STATISCHE BELASTBARKEIT
- ELEVADA RESISTENCIA A LAS CARGAS ESTÁTICAS

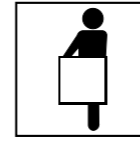

- FACILE DA POSARE
- EASY TO INSTALL
- FACILE À POSER
- VERLEGELEICHT
- FÁCIL DE COLOCAR



- ANTISCIVOLO R11
- ANTI SLIP R11
- ANTIDÉRAPANT R11
- RUTSCHFEST R11
- ANTIDESLIZANTE R11

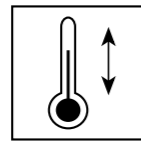

- RESISTENTE AGLI SBALZI TERMICI
- THERMAL SHOCK RESISTANT
- RÉSISTANT AUX ÉCARTS THERMIQUES
- TEMPERATURWECHSELBESTÄNDIG
- RESISTENTE A LAS OSCILACIONES TÉRMICAS

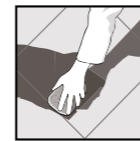

- FACILE DA PULIRE
- EASY TO CLEAN
- FACILE À NETTOYER
- REINIGUNGSGLEICHT
- FÁCIL DE LIMPIAR

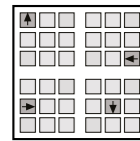

- RIMOVIBILE E RIUTILIZZABILE
- REMOVABLE AND REUSABLE
- DÉMONTABLE ET RÉUTILISABLE
- ENTFERNBAR UND WIEDERVERWENDBAR
- DESMONTABLE Y REUTILIZABLE



- INATTACCABILE DA AGENTI CHIMICI E MUFFE
- IMPERVIOUS TO ATTACK BY CHEMICALS OR MOULD
- RÉSISTANT AUX AGENTS CHIMIQUES ET AUX MOISSURES
- UNANGREIFBAR DURCH CHEMISCHE STOFFE UND SCHIMMEL
- RESISTENTE A LOS AGENTES QUÍMICOS Y A LOS MOHOS

Applicazioni - Applications - Applications - Verlegung - Aplicaciones

- Posa diretta su erba
- Direct installation on grass
- Pose direct sur de l'herbe
- Verlegung direkt auf Rasen
- Colocación directa sobre hierba

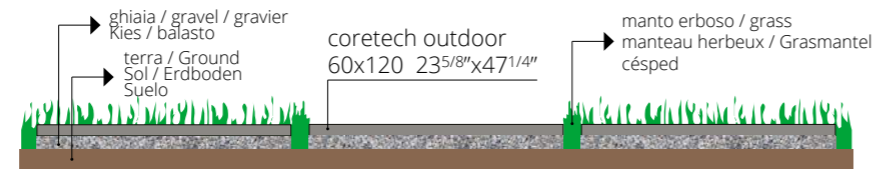

- Posa diretta su ghiaia
- Direct installation over gravel
- Pose direct sur du gravier
- Verlegung direkt auf Kies
- Colocación directa sobre grava

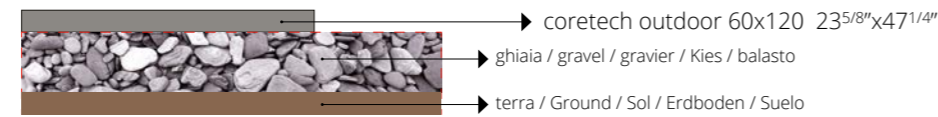

- Posa su massetto cementizio
- Installation on sand-cement screed
- Pose sur chape ciment
- Verlegung auf Zement-Unterbetonblock
- Colocación sobre contrapiso de hormigón

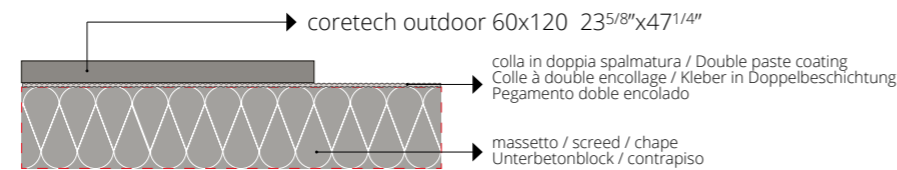

- Posa su piedini fissi o regolabili
- Installation on fixed or adjustable feet
- Pose sur pieds fixes ou réglables
- Verlegung auf feststehende oder regulierbare Füße
- Colocación sobre pies fijos o regulables

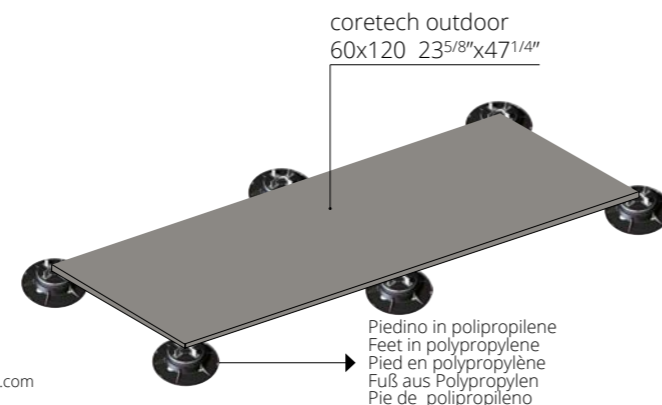

Per le specifiche di utilizzo dei sistemi sopraelevati vedi il sito florim.com
For the specifics on use of raised systems visit the site florim.com
Pour les caractéristiques d'utilisation des systèmes surélevés, voir le site florim.com
Für die Nutzungsbedingungen der Doppelbodensysteme siehe Webseite florim.com
Para las especificaciones de empleo de los sistemas sobreelevados consulte el sitio web florim.com

Le lastre ceramiche sono sottoposte a un trattamento di compattazione termica che assicura resistenza e durata nel tempo. Il bassissimo assorbimento d'acqua rende perciò il materiale ingelivo. Ciò può comportare ristagni d'acqua superficiali anche per materiale installato a regola d'arte. / Ceramic tiles undergo a compacting thermal treatment that ensures resistance and durability. The low level of water absorption makes the slabs frost resistant. This could result in superficial water stagnations even if materials are installed in a workmanlike manner. / Les carreaux de céramique subissent un traitement thermique de compactage qui assure résistance et durabilité. Le bas niveau d'absorption d'eau rend les dalles résistant au gel. Il pourrait en résulter des stagnations d'eau superficielles, même si les dalles ont été installées dans les règles de l'art. / Die Keramikplatten werden einer thermischen Verdichtung unterzogen, welche die Widerstandsfähigkeit und Langlebigkeit sichert. Die extrem niedrige Wasseraufnahme macht das Material frostsicher. Die hohe Materialdichte kann, auch bei einer perfekten Verlegung, eine längere Abtrocknungszeit von angestaumtem Wasser zur Folge haben. / Las baldosas cerámicas se someten a un tratamiento de compactación térmica que asegura resistencia y durabilidad. La baja absorción de agua hace que las baldosas resistan al hielo. Esto podría resultar en estancamientos superficiales de agua, incluso si los materiales están instalados según las reglas del arte.



FLAME LIGHT

GRES FINE PORCELLANATO FINE PORCELAIN STONEWARE/GRES CERAME FIN/FEINSTEINZEUG-KOLLEKTIONEN/GRES PORCELANICO FINO SQUADRATO - SQUARED - EQUARRI - REKTIFIZIERT - ESCUADRADO			
20 mm 3/4" ↓	COLOR	SURFACE	60x120 23 5/8" x 47 1/4"
CORETECH	FLAME LIGHT	STRUTTURATO	778955



CORETECH



SGBP 2018-1992

FLORIM OVERSIZE
magnlum

CE
FLORIM Ceramiche S.p.A SB Via Canaletto, 24 - 41042 Fiorano Modenese (MO) - Italia 05 FLORIM 001 EN 14411:2012 Dry-pressed ceramic tiles, with water absorption $E_b \leq 0,5\%$, for internal and external walls and floorings

Per informazioni relative ai dati tecnici su marcatura CE vedere il sito www.florim.com
 Please refer to our web site www.florim.com for technical information related to CE labeling
 Pour tout renseignement sur l'étiquetage CE veuillez consulter le site www.florim.com
 Informationen bezüglich technischer Daten zur Beschriftung CE entnehmen Sie unserer Website www.florim.com
 Para informaciones relativas a las especificaciones técnicas sobre la marca CE, chequear el sitio www.florim.com

CE
FLORIM Ceramiche S.p.A SB Via Canaletto, 24 - 41042 Fiorano Modenese (MO) - Italia 09 FLORIM 003 EN 14411:2012 Dry-pressed ceramic tiles, with water absorption $E_b \leq 0,5\%$, for internal and external walls and floorings

Per informazioni relative ai dati tecnici su marcatura CE vedere il sito www.florim.com
 Please refer to our web site www.florim.com for technical information related to CE labeling
 Pour tout renseignement sur l'étiquetage CE veuillez consulter le site www.florim.com
 Informationen bezüglich technischer Daten zur Beschriftung CE entnehmen Sie unserer Website www.florim.com
 Para informaciones relativas a las especificaciones técnicas sobre la marca CE, chequear el sitio www.florim.com



GRADO DI VARIAZIONE CROMATICA - DEGREE OF COLOUR CHANGE - DEGRE DE VARIATION CHROMATIQUE - GRAD DER FARBABWEICHUNG - GRADO DE VARIACIÓN CROMÁTICA

 V1 LOW THE LEAST AMOUNT OF SHADE AND TEXTURE VARIATION ATTAINABLE IN NATURALLY FIRED CLAY PRODUCTS. Prodotto Monocromatico Produit Monochromatique Einfarbiges Produkt Producto Monocromático	 V2 MODERATE LIGHT TO MODERATE SHADE AND TEXTURE VARIATION WITHIN EACH CARTON. Prodotto con leggera variazione cromatica Produit à légère variation chromatique Produkt mit leichter Farbnuance Producto con una pequeña variación cromática	 V3 HIGH HIGH SHADE AND TEXTURE VARIATION WITHIN EACH CARTON. Prodotto con marcata variazione cromatica Produit à variation chromatique accentuée Produkt mit ausgeprägter Farbnuance Producto con evidente variación cromática	 V4 RANDOM VERY HIGH SHADE AND TEXTURE VARIATION WITHIN EACH CARTON. Prodotto con forte variazione cromatica Produit à forte variation chromatique Produkt mit starker Farbnuance Producto con fuerte variación cromática
	BRUSHED LIGHT - FLAME LIGHT	SATIN DARK - FLAME DARK	

	Sistema di gestione della Qualità: Certificato n°. 50 100 1271
	Sistema di gestione dell'Ambiente: Certificato n°. 50 100 100 74
	Sistema di gestione della Salute e Sicurezza dei lavoratori: Certificato n°. 50 100 13825
	Sistema di gestione dell'Energia: Certificato n°. 50 100 13545



Quanto contenuto nel catalogo è indicativo e non esaustivo riguardo alle grafiche, decori e ai colori riportati. /Contents of this catalog is indicative and not exhaustive with regard to graphics, decors and colors shown. /Le contenu du catalogue est indicative et non exhaustive en ce qui concerne graphiques, décors et couleurs indiquées. /Die Beschreibungen im Katalog sind indikativ und nicht allumfassend in Bezug auf Grafiken, Dekore und Farben. /El contenido de este catálogo es indicativo y no exhaustivo con respecto a gráficas, decoros y colores ilustrados.



Florim Ceramiche S.p.A. SB

Via Canaletto, 24 / 41042 Fiorano Modenese (MO) / T. +39 0536 840111 / florim.com