

TONO



Foster + Partners PORCELANOSA



the design CONCEPT

TONO asks the important questions first. What's the most efficient volume of water? How can controls be made genuinely intuitive? Aesthetics derive from functionality and the innate properties of the materials used. With sinks incorporating an offset circle motif, each element has been consciously created to be quiet, purposeful and exact.

design & collaboration

No other organisation has a product palette as wide as Porcelanosa's. Marble, ceramics, Krion, timber, brassware and stainless steel. Its wide range of materials and techniques now meets with the vision of Foster+Partners in a perfect combination. TONO offers architects and designers a new insight in bathroom design. Two companies, one philosophy, infinite possibilities.



development & sustainability



The result of physical making rather than theoretical ideas, the performance of each TONO product has been optimised through rigorous testing, prototyping and human interaction. Together, Foster + Partners and Porcelanosa pushed themselves to develop something out of the ordinary: individually crafted components that simultaneously work holistically and harmoniously.

development

No more, no less. Just as eliminating superfluous detail makes for better design, it also enhances sustainability. As embodied by the 2.3 litre capacity TONO sink, which provides the right amount of water while cutting down on waste. Taps can be adjusted for optimum flow, while natural materials age beautifully.

sustainability

TONO

ELEMENTS

BASIN



BATH



BRASSWARE



WC



FURNITURE



ACCESSORIES



MIRRORS



TOWEL WARMER



MANÀ HOUSE

Bathrooms can be adapted to taste and context.
TONO is the example of all elements working
together.





In this Formentera house, each room becomes a real piece of art. The finishes used, blended with the landscape, unveil a clear and minimalist architecture. There is no decoration needed in a space that stands out because of its elements. The master bathroom is furnished with pieces designed by Foster+Partners and Porcelanosa. The bathtub and the washbasin are made of Krion, a mineral compound of high purity that matches perfectly in this space with chromed taps. A timeless touch.

BASINS

Sinks, either countertop or wall-mounted, are the perfect blend of functionality and minimalism. An example of this features is the concealed clicker mechanism.





Basin Countertop 400 Angled

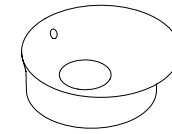

Corner Basin 420 Angled

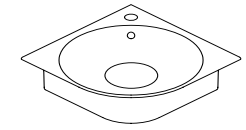

Basin Countertop 400 Straight

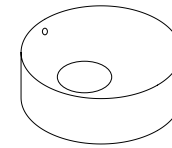

Basin Countertop 600 Straight

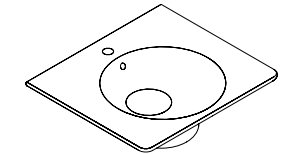

Basin Wall Mounted 400

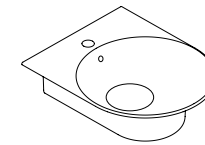

Basin Wall Mounted 800

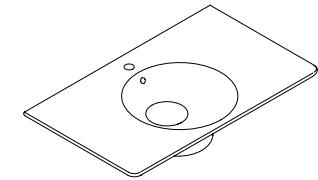

Basin Wall Mounted 600

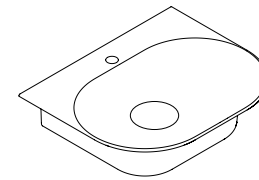

Basin Wall Mounted 1200

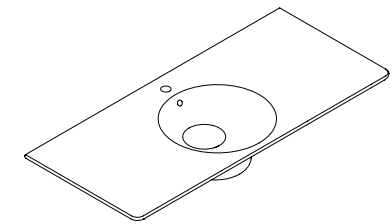

Basin Wall Mounted 1200

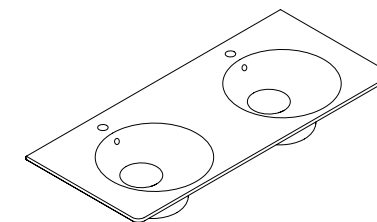

OLHÃO HOTEL

Olhao is a hotel to dream about. A place that inspires you to appreciate life while having a bath in the Tono bathtub or enjoy a wellness moment under the shower.



BRASSWARE

Taps are shaped to catch the light. The bevelled cut on the control lever together with the textured surface are the key to lure curiosity towards its performance system.





Basin Mixer

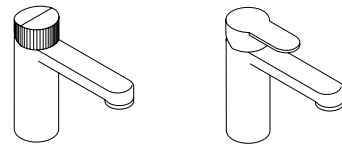

Bidet Mixer

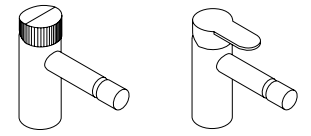

High Basin Mixer

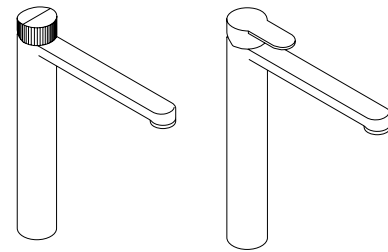

Floor Mounted Bath Filler with Hand Shower

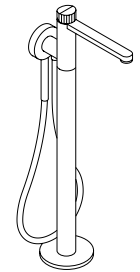

Sensor Tap

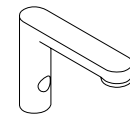

Bath Set

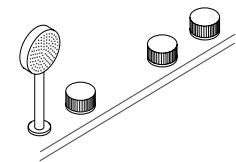

Wall Mounted Mixer With Round Spout

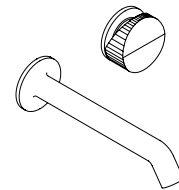

Shower head

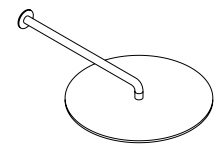

Wall Mounted Mixer With Flat Spout

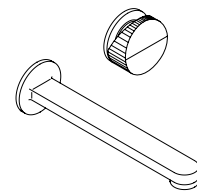

Thermostatic 2-Way Shower Set

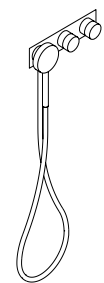

CONTACTLESS BATHROOM

Electronic taps with automatic sensors are the solution that guarantees health and safety in the bathroom as they are touchless operated.

We are constantly in contact with the world through our hands and they act as a connecting thread between our bodies and external elements. Further than washing our hands to prevent the spread of infections and germs, there are now technological solutions that are an efficient barrier to protect ourselves and others. Moreover, electronic taps reduce water consumption as the tap opens and closes automatically guided by movement without having to touch it.



SAVAGE HOUSE

This urban retreat in the capital city of Vietnam, Ho Chi Minh, fosters an oasis of calm by integrating a combination of plants and lots of light.



KRION ACRYLIC STONE

Freestanding bathtubs have become the central element of bathrooms. In this collection designed by Foster+Partners for Porcelanosa, we can find them in different finishes and materials, providing a wide range of features in the same element. Krion bathtub are comfortable to touch, hygienic and safe thanks to the low porosity of this material that avoids bacteria proliferation.

Greater resistance, durability and easy maintenance are the three features that define acrylic bathtubs. Finally, the grandeur of natural stone makes these bathtubs a unique product since every stone is unique. This product turns out to be a collectible that everybody would love to have.





BATHTUB

Despite its minimalist design, this bathtub includes hydromassage equipment to create an incredible atmosphere of well-being, the convenience of a home spa. The elegance and strong personality of the built-in bathtub are linked to the revitalization therapies for body and soul provided by the hydrotherapy and chromotherapy systems.

The Air equipment is a propulsion of air bubbles that create a soft and involving massage for the user to enjoy. The air + equipment also introduces chromotherapy lights, a combination of colors that have a positive influence in our mood.



Different options of this signature piece: a freestanding bathtub and a concealed bathtub of 190, 180 and 170 cm. Made of lucite acrylic, a material that is comfortable to touch and highly durable, as well as having a good heat retention and a bright look that lasts over time.



CENIT HOUSE

The bath concept in an urban utopia.



TOILET

Wall-hung toilets made of high compact ceramics that guarantees exceptional resistance. The pure white ceramic tone provides a roomy and serene look in a minimalist bathroom. Moreover, sustainability is not forgotten since they are installed with reduced flush cisterns of 4.5-3 liters capacity.





PERDIGÓ HOTEL

A composition of idyllic villas in Bali. All of them built with wooden materials and its own infinity pool, a place to let yourself go.

FURNITURE

Completing TONO's attention to detail, furniture is a key part of the concept. Sliding storage units are built into the mirrors and lights are conveniently positioned around their circumference for perfect and elegant illumination. A horizontal bench unifies this design where pure lines of the make-up desk optimise the space due to its flawlessly engineered drawers.







MIRRORS

As well as different finishes, TONO mirrors not only incorporate lights around their circumference for perfect lighting but also a tactile sensor control and demister function.

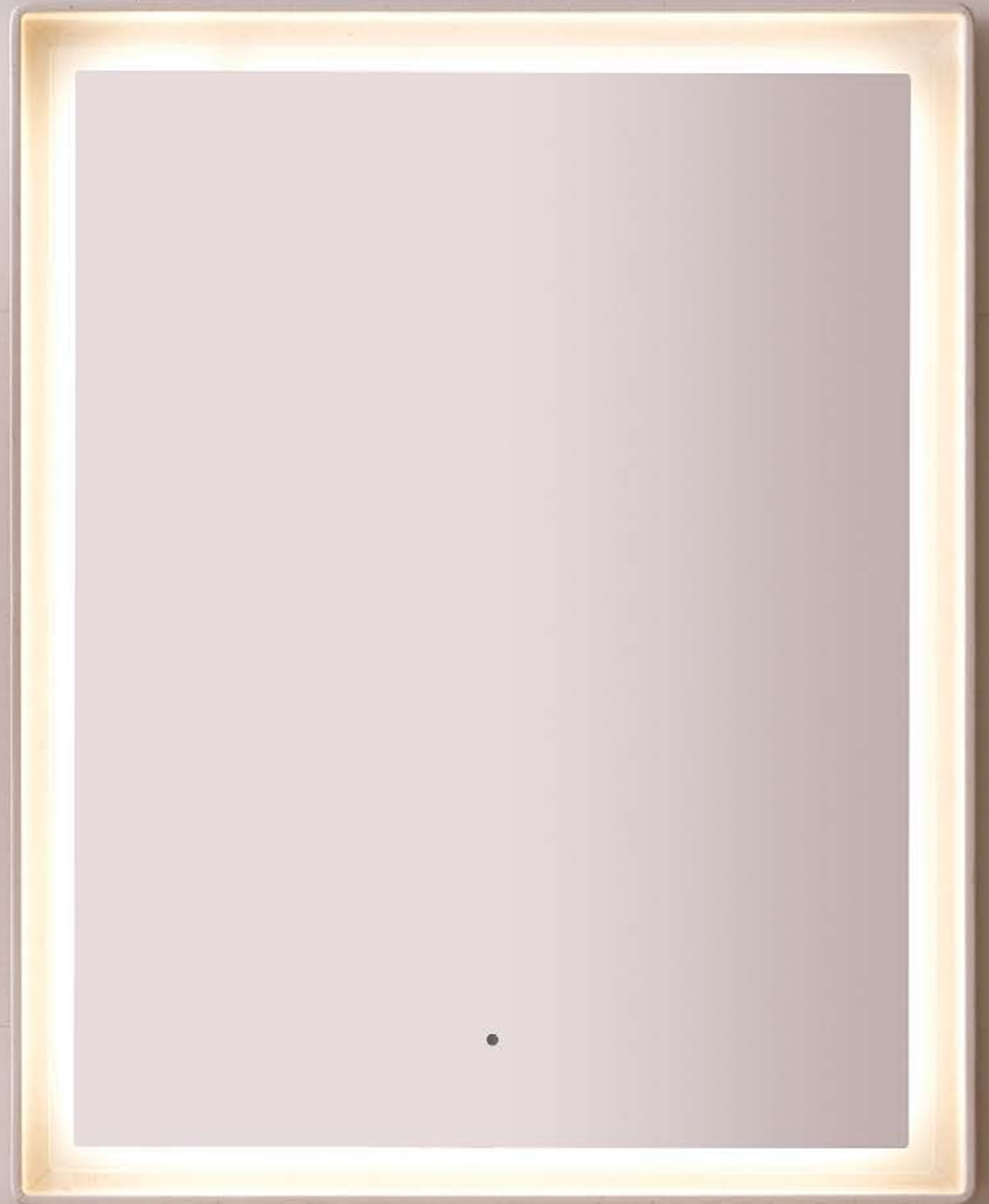

Mirror D 800 / D 950 / D 1000

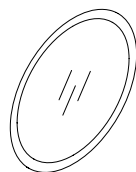

Mirror 800×1000



Mirror 1200×1000

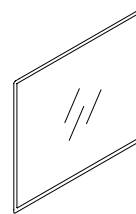

Mirror 1600×1000

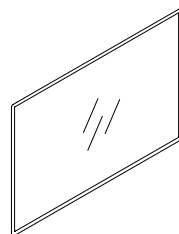

Magnifying Mirror



ACCESSORIES

The practical minimalism by Foster + Partners is also reflected in the accessories. A wide range of towel rails, robe hooks, soap dispensers and other elements provide a distinctive touch to each bathroom.



TOWEL WARMER

Our passion for the design of contemporary bathrooms through elements which combine aesthetics and functionality has led us to develop different product lines to offer a complete set of bathroom fittings which also accommodate secondary elements, often unnoticed but nevertheless crucial when creating comfortable rooms.





PURE MODULARITY AND VERSATILITY

The collection stands out because of its modularity, offering multiple possibilities in terms of combinations between the different elements. Aiming to create modern and creative bathroom spaces. TONO adapts to all needs, offering a bathroom design without forgetting practical features.

Tono sees pieces with a signature seal made of high-quality materials, which go hand in hand with harmony while improving people's quality of life. A comprehensive and built-in bathroom with an endless selection of finishes and materials. The equipment which needs a custom-made bathroom.





TECHNICAL ZONE

TONO Elements: Washbasins

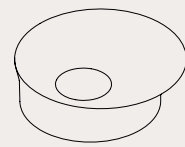
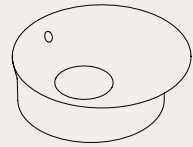

TONO Elements: Washbasins

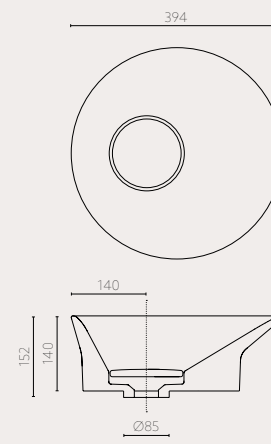
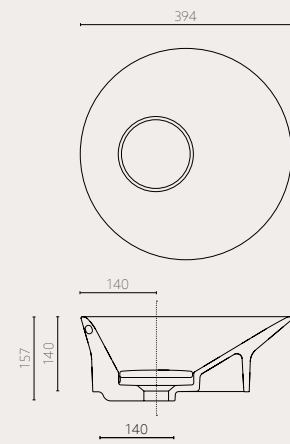
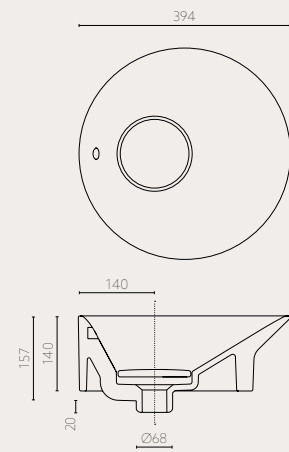
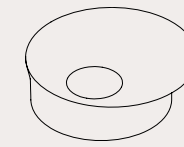

Ceramic Basin Countertop 400 Angled

Features:

- Clicker waste with ceramic cover
- Overflow CL10
- Nk Protect/Compact Ceramic Technology
- Chemical resistant
- Easy-clean surface

Krion Basin Countertop 400 Angled

Features:

- Clicker waste with Krion® cover
- Hidden Overflow CL10
- Repairable
- Easy-clean
- Krion®Solid is Greenguard Gold Certified

Stone Basin Countertop 400 Angled

Features:

- Stone cover available with fixed waste
- Hand finished matt surface
- Stone Protection coating to resist stains and bacteria
- Without overflow

Note:

Stone is a natural product which may be subject to variations in shade. The colour of the material supplied may differ slightly from that shown. Stone basins are supplied without an overflow system



Finishes:

-  Noken Ceramic®

Finishes:

-  Krion®Solid

Finishes:

-  Habana Dark
-  Capuccino Grey
-  Calgary

TONO Elements: Washbasins

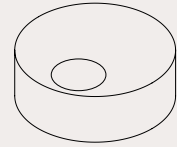
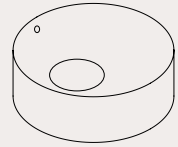

TONO Elements: Washbasins

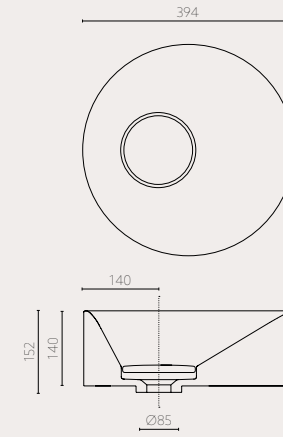
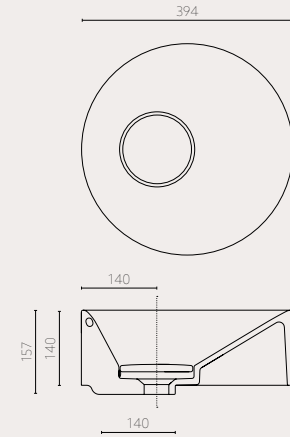
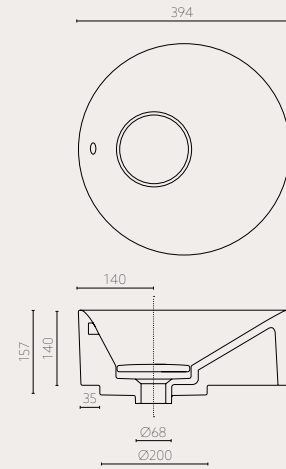
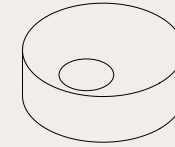

Ceramic Basin Countertop 400 Straight

Features:

- Clicker waste with ceramic cover
- Overflow CL10
- Nk Protect/Compact Ceramic Technology
- Chemical resistant
- Easy-clean surface

Krion Basin Countertop 400 Straight

Features:

- Clicker waste with Krion® cover
- Hidden Overflow CL10
- Krion®Solid is GreenGuard Gold Certified
- Chemical Resistant
- Easy-clean
- Repairable

Stone Basin Countertop 400 Straight

Features:

- Stone cover available with fixed waste
- Hand finished matt surface
- Stone Protection coating to resist stains and bacteria
- Without overflow

Note:

Stone is a natural product which may be subject to variations in shade. The colour of the material supplied may differ slightly from that shown. Stone basins are supplied without an overflow system



Finishes:

-  Noken Ceramic®

Finishes:

-  Krion®Solid

Finishes:

-  Habana Dark
-  Capuccino Grey
-  Calgary

TONO Elements: Washbasins

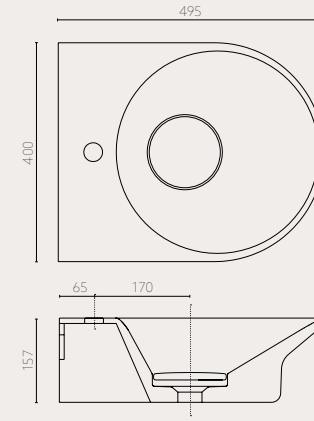
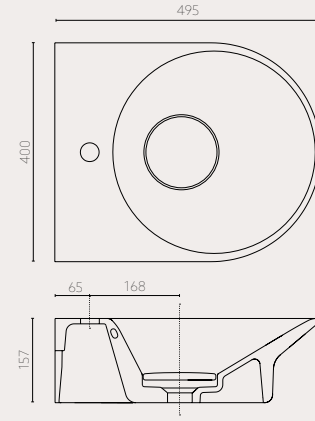
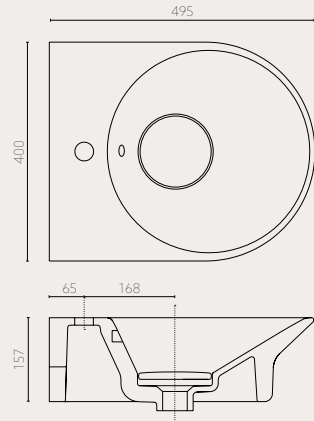
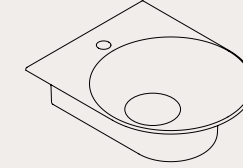
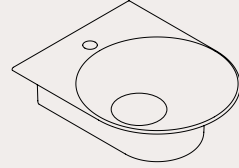
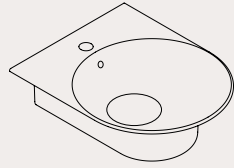

Ceramic Basin Wall Mounted 400

Features:

- Clicker waste with ceramic cover
- Overflow CL10
- Nk Protect/Compact Ceramic Technology
- Chemical resistant
- Easy-clean surface

Krion Basin Wall Mounted 400

Features:

- Clicker waste with Krion® cover
- Hidden Overflow CL10
- Krion®Solid is GreenGuard Gold Certified
- Chemical Resistant
- Easy-clean
- Repairable

Stone Basin Wall Mounted 400

Features:

- Stone cover available with fixed waste
- Hand finished matt surface
- Stone Protection coating to resist stains and bacteria
- Metal bracket
- Without overflow

Note:

Stone is a natural product which may be subject to variations in shade. The colour of the material supplied may differ slightly from that shown. Stone basins are supplied without an overflow system



Finishes:

 Noken Ceramic®

Finishes:

 Krion®Solid

Finishes:

-  Habana Dark
-  Capuccino Grey
-  Calgary

TONO Elements: Washbasins

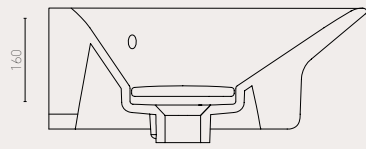
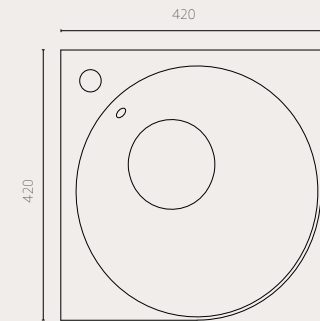
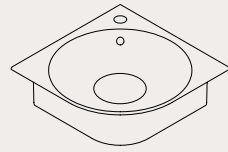

Ceramic Basin Wall Mounted Corner 420

Features:

- Clicker waste with ceramic cover
- Overflow CL10
- Nk Protect/Compact Ceramic Technology
- Chemical resistant
- Easy-clean surface

Finishes:

- Noken Ceramic®

TONO Elements: Washbasins

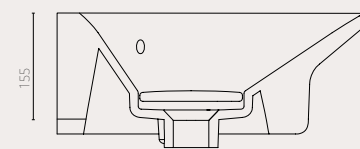
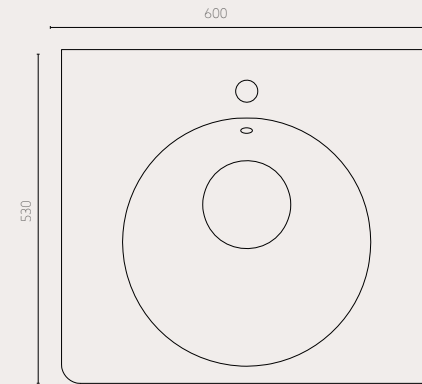
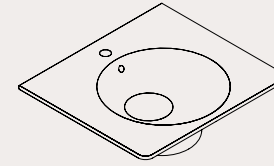

Ceramic Basin Wall Mounted 600

Features:

- Clicker waste with ceramic cover
- Overflow CL10
- Nk Protect/Compact Ceramic Technology
- Chemical resistant
- Easy-clean surface

Finishes:

- Noken Ceramic®

TONO Elements: Washbasins

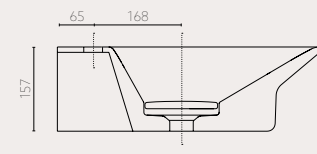
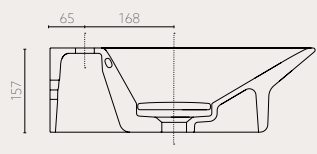
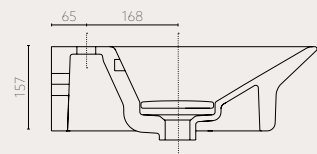
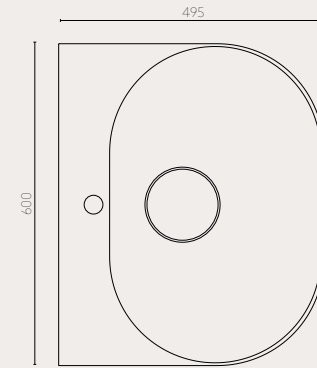
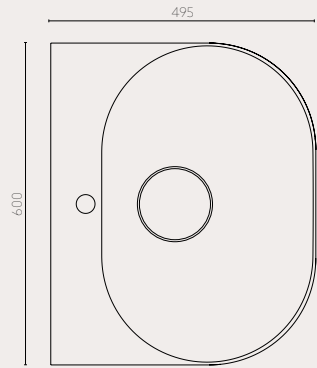
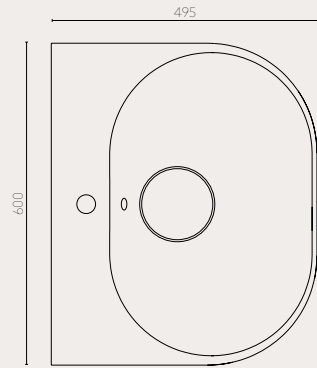
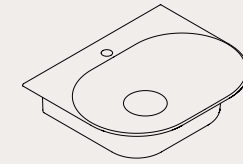
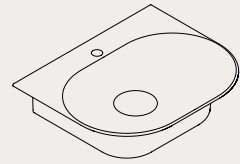
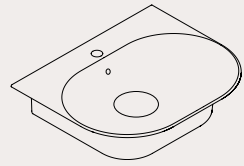

Ceramic Basin Wall Mounted 600

Features:

- Clicker waste with ceramic cover
- Overflow CL10
- Nk Protect/Compact Ceramic Technology
- Chemical resistant
- Easy-clean surface

Krion Basin Wall Mounted 600

Features:

- Clicker waste with Krion® cover
- Hidden Overflow CL10
- Krion®Solid is GreenGuard Gold Certified
- Chemical Resistant
- Easy-clean
- Repairable

Stone Basin Wall Mounted 600

Features:

- Stone cover available with fixed waste
- Hand finished matt surface
- Stone Protection coating to resist stains and bacteria
- Metal bracket
- Without overflow

Note:

Stone is a natural product which may be subject to variations in shade. The colour of the material supplied may differ slightly from that shown. Stone basins are supplied without an overflow system

Finishes:



Noken Ceramic®

Finishes:

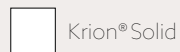

Krion®Solid

Finishes:

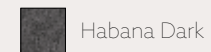

Habana Dark

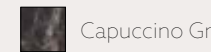

Capuccino Grey

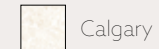

Calgary

TONO Elements: Washbasins

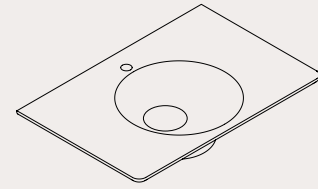
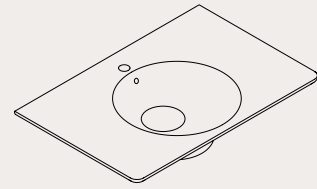

TONO Elements: Washbasins

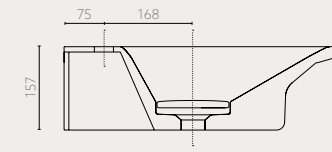
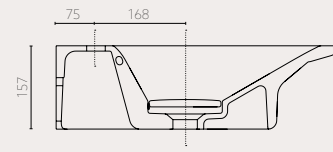
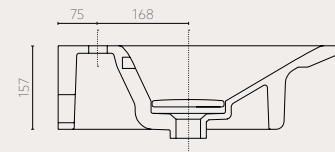
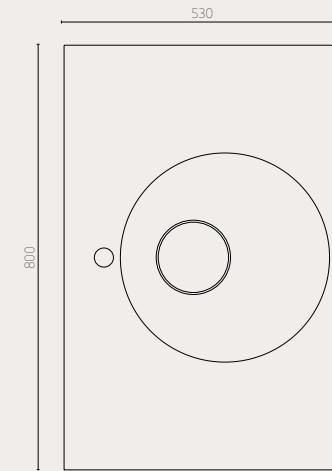
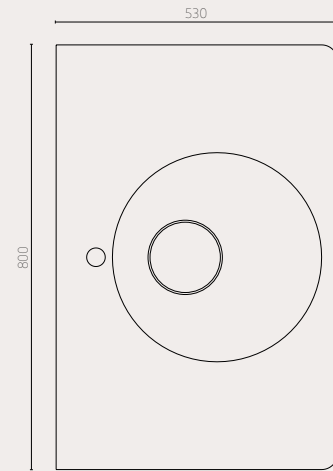
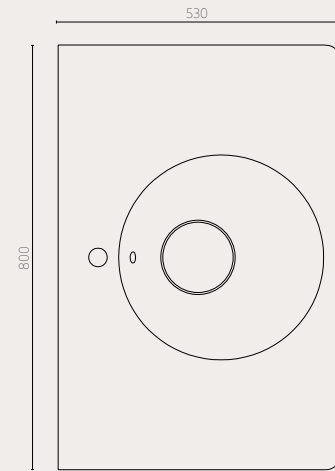
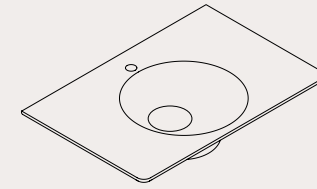

Ceramic Basin Wall Mounted 800

Features:

- Clicker waste with ceramic cover
- Overflow CL10
- Nk Protect/Compact Ceramic Technology
- Chemical resistant
- Easy-clean surface

Krion Basin Wall Mounted 800

Features:

- Clicker waste with Krion® cover
- Hidden Overflow CL10
- Krion®Solid is GreenGuard Gold Certified
- Chemical Resistant
- Easy-clean
- Repairable

Stone Basin Wall Mounted 800

Features:

- Stone cover available with fixed waste
- Hand finished matt surface
- Stone Protection coating to resist stains and bacteria
- Metal bracket
- Without overflow

Note:

Stone is a natural product which may be subject to variations in shade. The colour of the material supplied may differ slightly from that shown. Stone basins are supplied without an overflow system



Finishes:

-  Noken Ceramic®

Finishes:

-  Krion®Solid

Finishes:

-  Habana Dark
-  Capuccino Grey
-  Calgary

TONO Elements: Washbasins

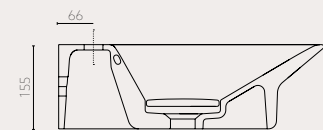
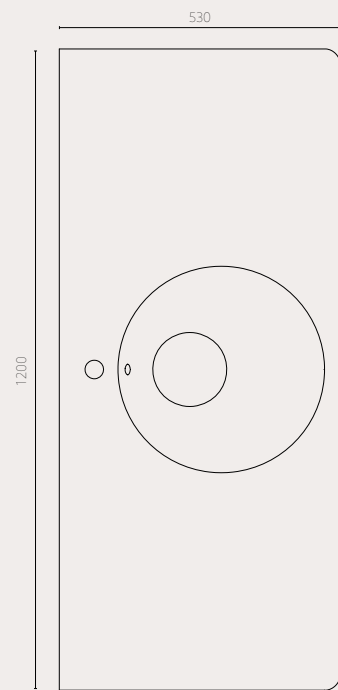
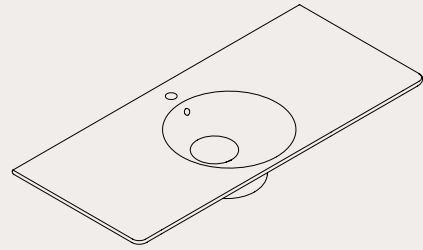

Ceramic Basin Wall Mounted 1200

Features:

- Clicker waste with ceramic cover
- Overflow CL10
- Nk Protect/Compact Ceramic Technology
- Chemical resistant
- Easy-clean surface

Finishes:

 Noken Ceramic®

TONO Elements: Washbasins

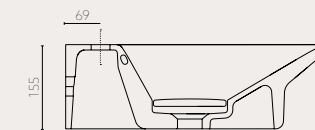
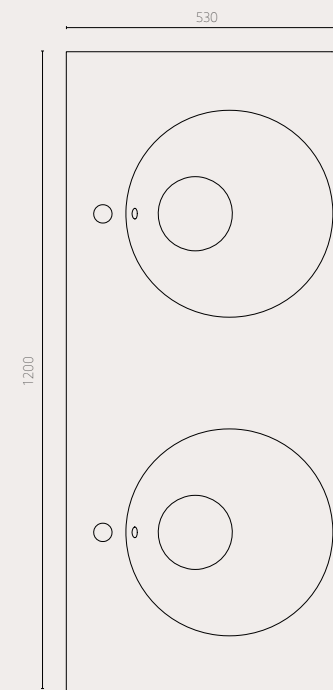
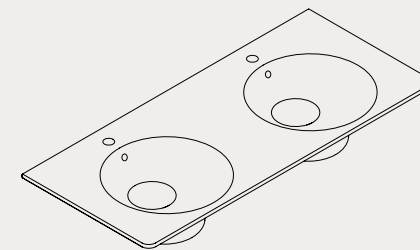

Ceramic Double Bowl Basin Wall Mounted 1200

Features:

- Clicker waste with ceramic cover
- Overflow CL10
- Nk Protect/Compact Ceramic Technology
- Chemical resistant
- Easy-clean surface

Finishes:

 Noken Ceramic®

TONO Elements: Brassware

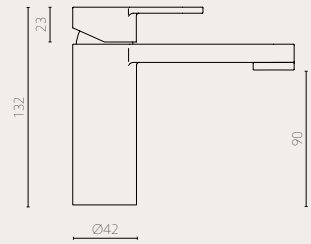
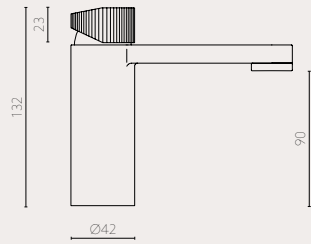
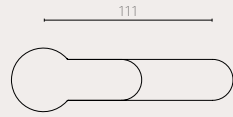
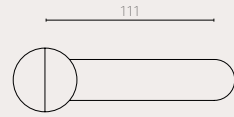
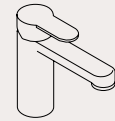
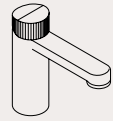

Basin Mixer

Features:
Ø25 mm Ceramic cartridge
Flow rate: 5.7 l/min at 3 bar
Cartridge reliability meeting:
European standard EN 817 and
American standard ASME A112.18.1M
Adjustable aerator
Aerator for different building ratings available
Ni-Cr coating tested to EN 248
Flexi hose 3/8" connection, length 450mm
Optional Ø48mm washer included

Basin Mixer with Lever

Features:
Ø25 mm Ceramic cartridge
Flow rate: 5.7 l/min at 3 bar
Cartridge reliability meeting:
European standard EN 817 and
American standard ASME A112.18.1M
Adjustable aerator
Aerator for different building ratings available
Ni-Cr coating tested to EN 248
Flexi hose 3/8" connection, length 450mm
Optional Ø48mm washer included

Finishes:



Finishes:



TONO Elements: Brassware

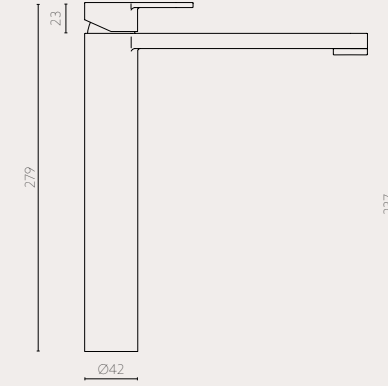
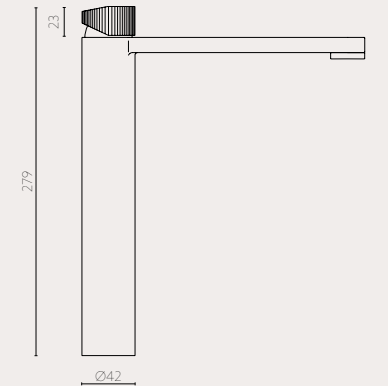
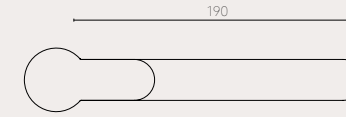
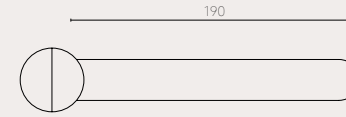
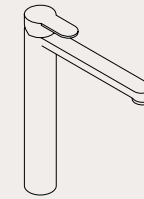
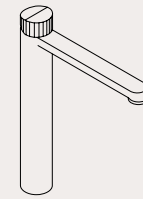

High Basin Mixer

Features:
Ø25 mm Ceramic cartridge
Flow rate: 5.7 l/min at 3 bar
Cartridge reliability meeting:
European standard EN 817 and
American standard ASME A112.18.1M
Adjustable aerator
Aerator for different building ratings available
Ni-Cr coating tested to EN 248
Flexi hose 3/8" connection, length 450mm
Optional Ø48mm washer included

High Basin Mixer with Lever

Features:
Ø25 mm Ceramic cartridge
Flow rate: 5.7 l/min at 3 bar
Cartridge reliability meeting:
European standard EN 817 and
American standard ASME A112.18.1M
Adjustable aerator
Aerator for different building ratings available
Ni-Cr coating tested to EN 248
Flexi hose 3/8" connection, length 450mm
Optional Ø48mm washer included

Finishes:



Finishes:



TONO Elements: Brassware

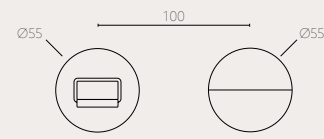
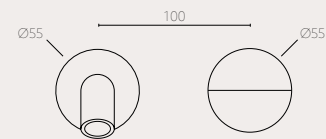
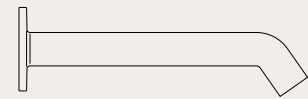
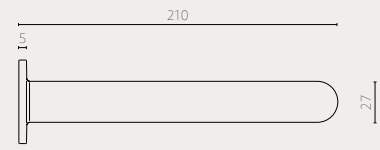
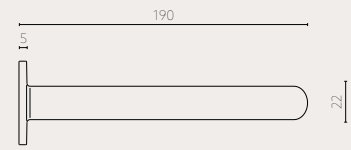
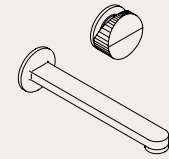
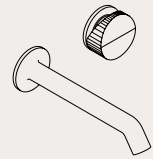

Wall Mounted Mixer With Round Spout

Features:
 Ø35 mm Ceramic cartridge
 Flow rate: 5.7 l/min at 3 bar
 Cartridge reliability meeting:
 European standard EN 817 and
 American standard ASME A112.18.1M
 Adjustable aerator
 Aerator for different building ratings available
 Ni-Cr coating tested to EN 248

Wall Mounted Mixer With Flat Spout

Features:
 Ø35 mm Ceramic cartridge
 Flow rate: 5.7 l/min at 3 bar
 Cartridge reliability meeting:
 European standard EN 817 and
 American standard ASME A112.18.1M
 Adjustable aerator
 Aerator for different building ratings available
 Ni-Cr coating tested to EN 248

Finishes:



Finishes:



TONO Elements: Brassware

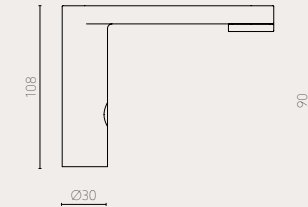
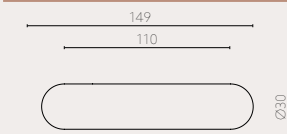
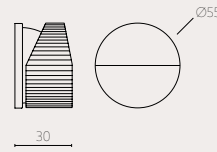
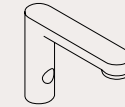

Wall Mounted Mixer

Features:
 Ø35 mm Ceramic cartridge
 Max. flow rate: 20 l/min at 3 bar
 Cartridge reliability meeting:
 European standard EN 817 and
 American standard ASME A112.18.1M
 Ni-Cr coating tested to EN 248
 1/2" connection

Sensor Tap

Features:
 Sensor-operated
 Flow rate: 5.7 l/min at 3 bar
 Ni-Cr coating tested to EN 248
 6V Battery connection
 Single water inlet
 Optional Ø48mm washer included
 Adjustable aerator
 Aerator for different building ratings available

Finishes:



Finishes:



TONO Elements: Brassware

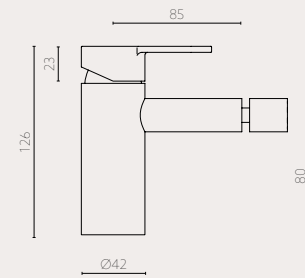
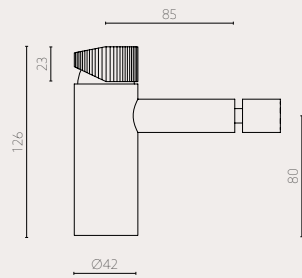
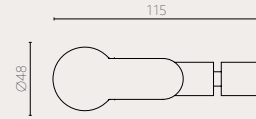
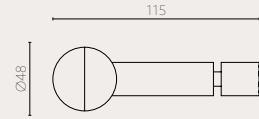
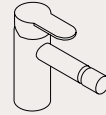
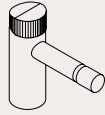

Bidet Mixer

Features:
Ø25 mm Ceramic cartridge
Flow rate: 5.7 l/min at 3 bar
Cartridge reliability meeting:
European standard EN 817 and
American standard ASME A112.18.1M
Adjustable aerator
Aerator for different building ratings available
Ni-Cr coating tested to EN 248
Flexi hose 3/8" connection, length 400mm
Optional Ø48mm washer included

Finishes:



Bidet Mixer Lever

Features:
Ø25 mm Ceramic cartridge
Flow rate: 5.7 l/min at 3 bar
Cartridge reliability meeting:
European standard EN 817 and
American standard ASME A112.18.1M
Adjustable aerator
Aerator for different building ratings available
Ni-Cr coating tested to EN 248
Flexi hose 3/8" connection, length 400mm
Optional Ø48mm washer included

Finishes:



TONO Elements: Brassware

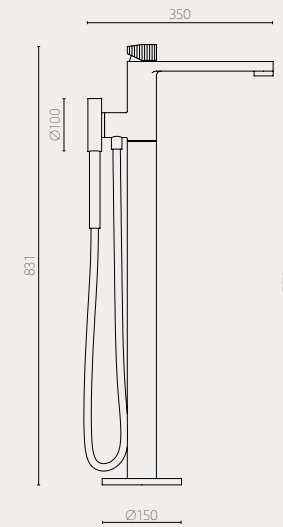
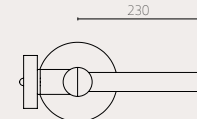
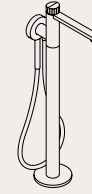

Floor Mounted Bath Filler with Hand Shower

Features:
Ø40mm Ceramic cartridge with Integrated diverter
Spout flow rate: 19 l/min at 3 bar.
Includes Hand Shower and magnetic bracket
Hand Shower flow rate: 6,8 l/min at 3 bar
Adjustable aerator
Aerator for different building ratings available
Cartridge reliability meeting:
European standard EN 817 and
American standard ASME A112.18.1M
Ni-Cr coating tested to EN 248

Finishes:



TONO Elements: Brassware

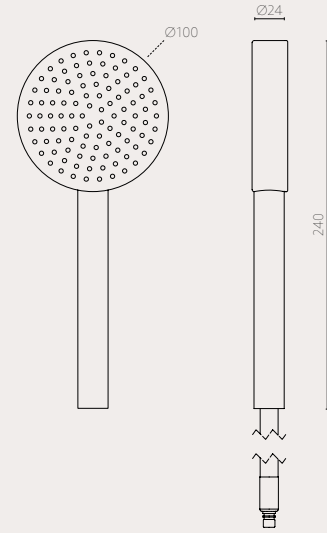
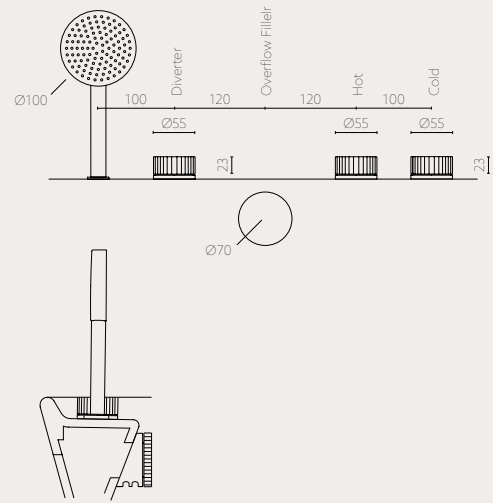
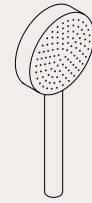
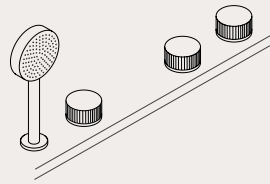

Bath Set

Including:
Hand Shower
Grommet
Hose
Diverter
Pair of valves (hot and cold)

Related items:
Krion Bathtub Freestanding

Finishes:



Hand Shower

Features:
Flow rate: 6.8 l/min at 3 bar
Ni-Cr coating tested to EN 248

Finishes:



TONO Elements: Brassware

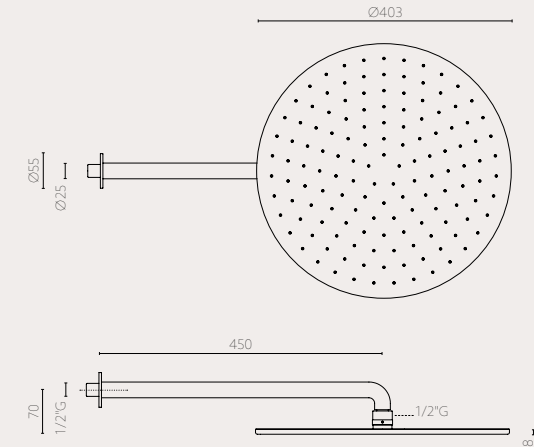
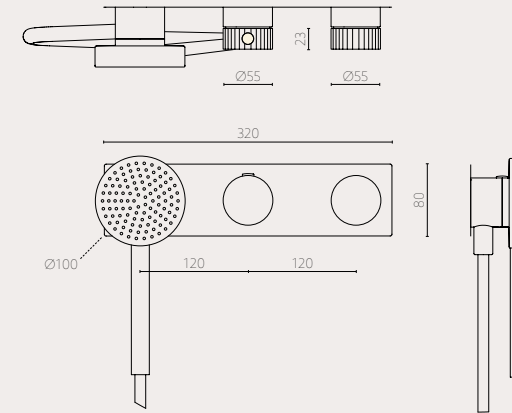
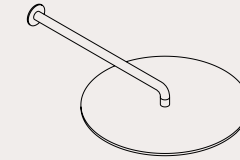

Thermostatic 2-Way Shower Set

Features:
Includes Hand Shower and magnetic bracket
Thermostatic Element flow rate: 25 l/min at 3 bar
Hand Shower flow rate: 6.8 l/min at 3 bar
38°C safety stop
48°C temperature limit
Built-in non-return valves
Cartridge reliability meeting:
European standard EN 1111
Ni-Cr coating tested to EN 248

Finishes:



Shower Head 400

Features:
400mm diameter
Flow rate: 18 l/min at 3 bar
450 mm wall installation arm included
Ni-Cr coating tested to EN 248

Finishes:



TONO Elements: Brassware

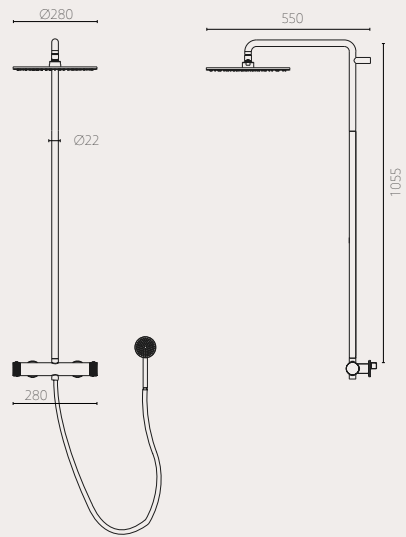
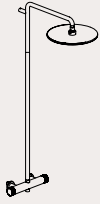

Shower column

Features:

Thermostatic Shower Column
Built-in wax thermoelement
Shower Head Magnetic Bracket
Magnetic Hand Shower
38°C Temperature Limit
Non-return Valve
Flow Rate Hand Shower: 6 l/min at 3 bar
Flow Rate Shower Head: 7,8 l/min at 3 bar

Finishes:

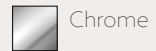

Chrome

TONO Elements: Sanitaryware

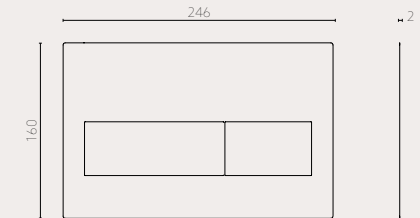
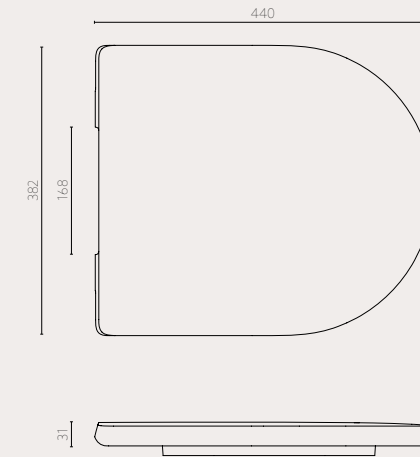
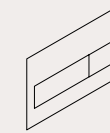
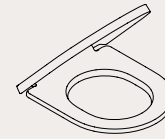

Toilet Seat and Lid

Features:

Soft close mechanism with 10 year warranty
Comfort design
Produced in Formaldehyde

Finishes:



Formaldehyde/White

Dual Flush Button

Features:

Compatible with Noken SMART LINE concealed cistern
Stainless steel AISI 304

Finishes:



Brushed stainless steel



Gold



Brushed gold



Titanium



Brushed titanium



Copper



Brushed copper

TONO Elements: Sanitaryware

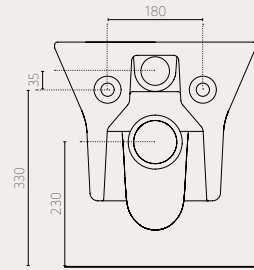
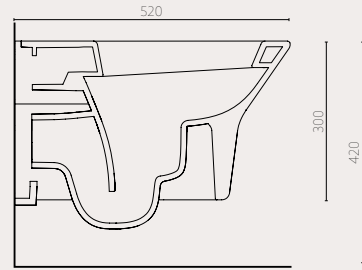
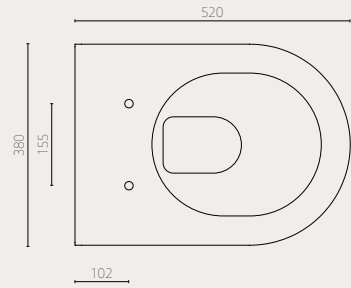
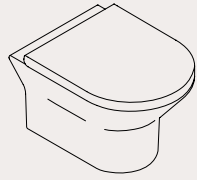

Wall Mounted Toilet

Features:

- Compatible with 3 – 4.5 litre cisterns
- Installation onto in-wall carrier system
- Concealed fixings included
- Nk Protect/Compact Ceramic Technology
- Chemical resistant
- Easy-clean surface

Finishes:



Noken Ceramic®

TONO Elements: Sanitaryware

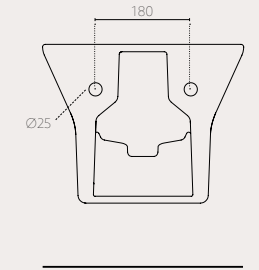
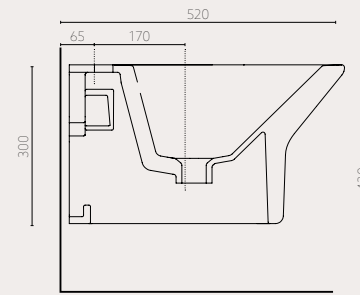
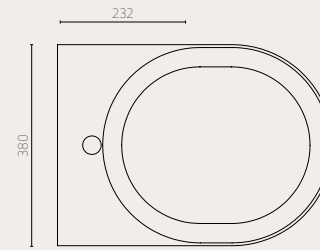
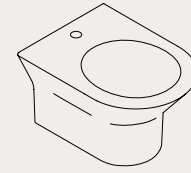

Wall Mounted Bidet

Features:

- Clicker waste with ceramic cover included
- Overflow CL10
- Installation onto in-wall carrier system
- Concealed fixings included
- Nk Protect/Compact Ceramic Technology
- Chemical resistant
- Easy-clean surface

Finishes:



Noken Ceramic®

TONO Elements: Bathtubs

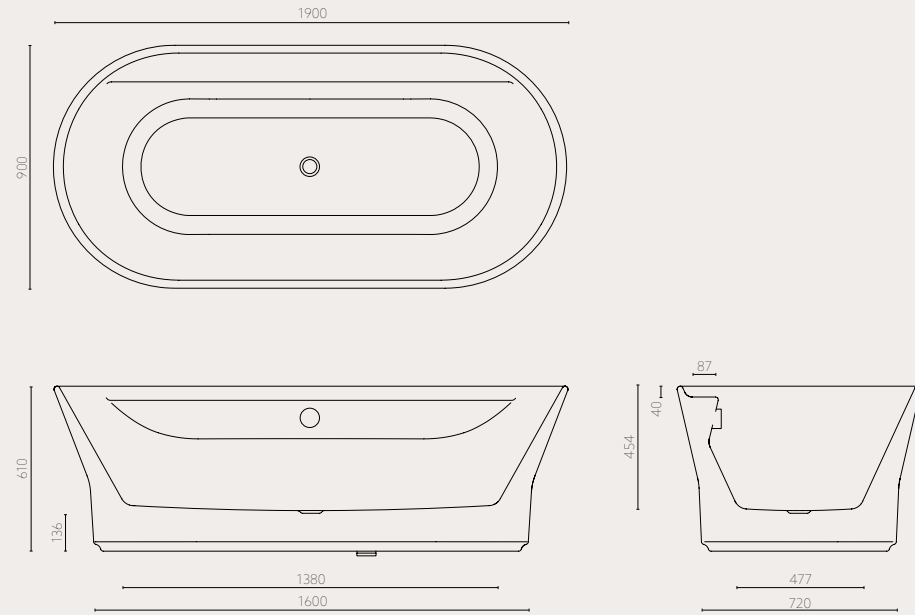
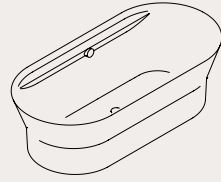

Acrylic Freestanding Bathtub

- Features:
- Double-ended design with central drain
 - Integrated shelf
 - Waste and overflow included
 - Easy-clean

Finishes:
 Lucite Acrylic

- Chrome
- Titanium
- Copper

TONO Elements: Bathtubs

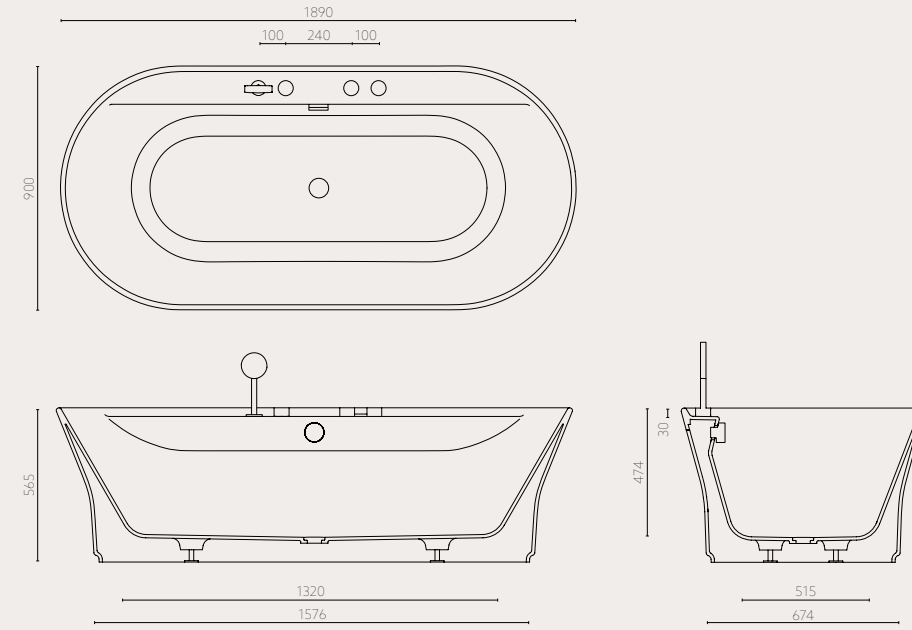
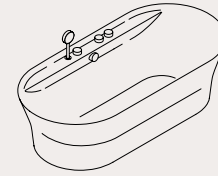

Krion Freestanding Bathtub

- Features:
- Double-ended design with central drain
 - Integrated shelf
 - Integrated Hot and Cold valves
 - 2-way diverter and Hand Shower Set
 - Integrated drain with overflow/filler
 - Krion®Solid is GreenGuard Gold Certified
 - Ni-Cr coating tested to EN 248
 - Chemical Resistant
 - Easy-clean
 - Repairable

Finishes:
 Krion®Solid

- Chrome
- Titanium
- Copper

TONO Elements: Bathtubs

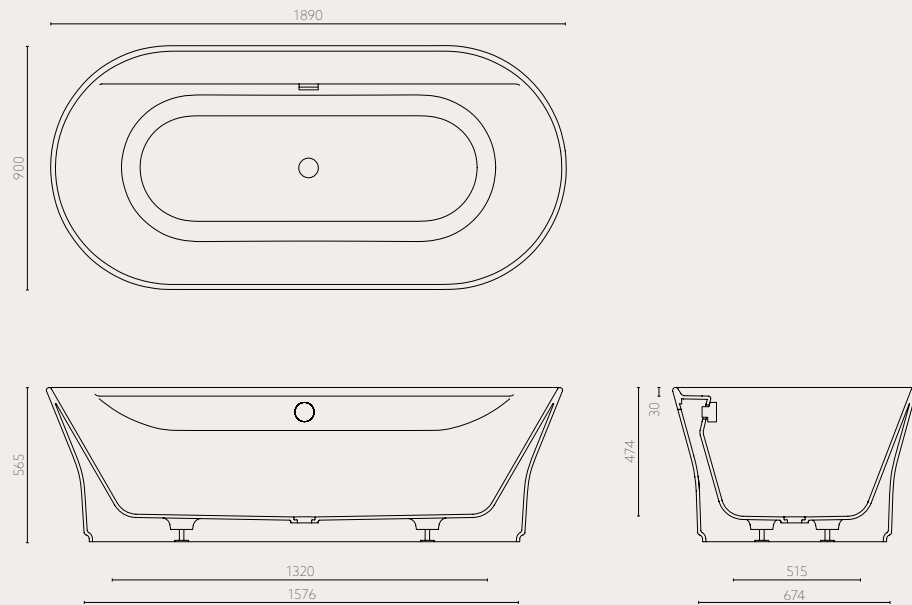
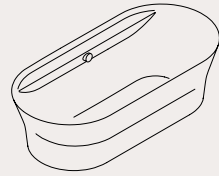

Krion Freestanding Bathtub

Features:

- Double-ended design with central drain
- Integrated shelf
- Integrated drain with overflow
- Krion®Solid is GreenGuard Gold Certified
- Ni-Cr coating tested to EN 248
- Chemical Resistant
- Easy-clean
- Repairable

Finishes:

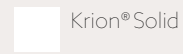

Krion®Solid

TONO Elements: Bathtubs

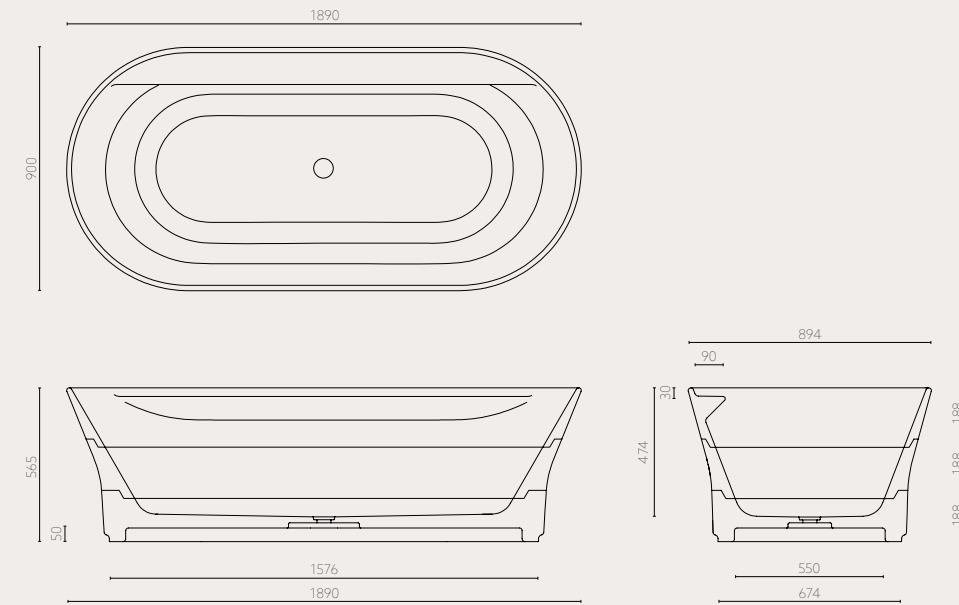
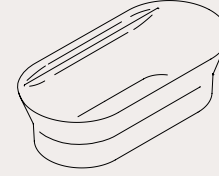

Stone Freestanding Bathtub

Features:

- Integrated shelf
- Hand finished matt surface
- Stone Protection coating to resist stains and bacteria
- Installation Kit included
- Without overflow

Note:

Stone is a natural product which may be subject to variations in shade. The colour of the material supplied may differ slightly from that shown. Stone Baths are supplied without an overflow system

Finishes:

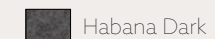

Habana Dark



Capuccino Grey

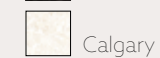

Calgary

TONO Elements: Bathtubs

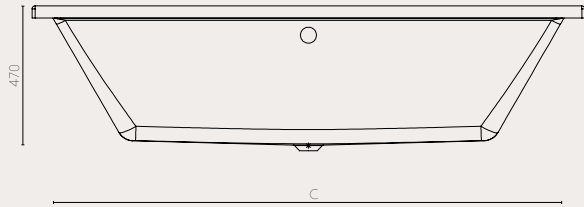
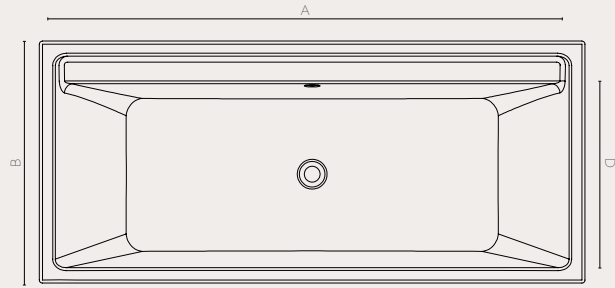
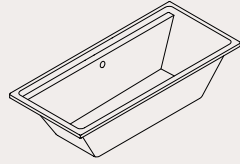

mm	A	B	C	D
1700 x 700	1700	700	1620	530
1800 x 800	1800	800	1720	630
1900 x 900	1900	900	1820	730

Acrylic Whirl Tub

- Features:
- Integrated shelf
 - Integrated drain with overflow
 - Built-in version with support frame
 - Without brassware

Finishes:

Lucite Acrylic

TONO Elements: Bathtubs

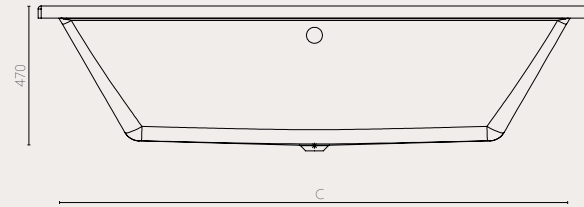
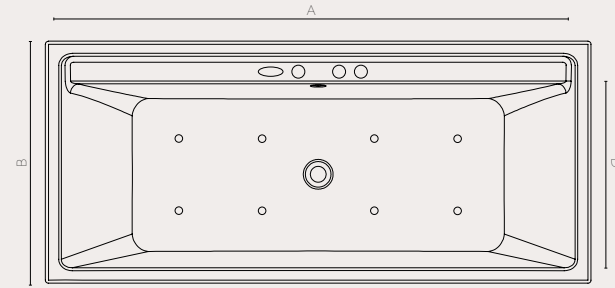
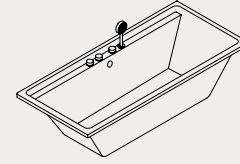

mm	A	B	C	D
1700 x 700	1700	700	1620	530
1800 x 800	1800	800	1720	630
1900 x 900	1900	900	1820	730

Acrylic Whirl Tub

- Features:
- Integrated shelf
 - Integrated drain with overflow
 - Built-in version with support frame
 - With AIR system
 - With brassware

Finishes:

Lucite Acrylic

TONO Elements: Furniture

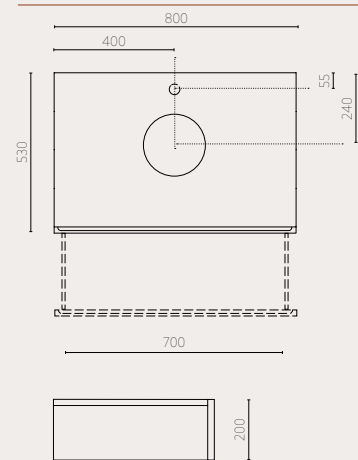
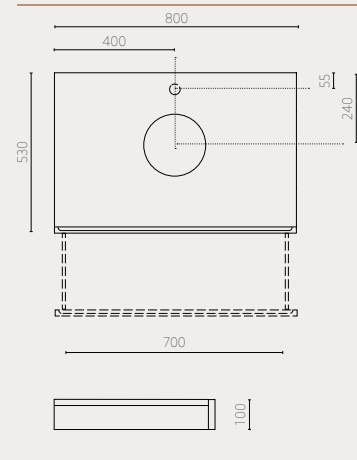
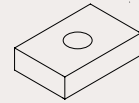
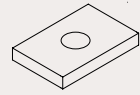

Wall Hung Drawer 800 × 100

- Features:
- Designed for Single Basin installation
 - Made with solid timber from sustainably managed forests
 - Wall brackets included
 - Soft-close runners
 - Compatible with TONO Countertop Basins
 - Compatible with TONO Countertop Bottle Trap Set

Allows for seated dresser configurations

Finishes:

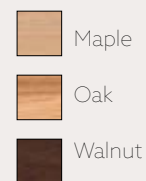

Wall Hung Drawer 800 × 200

- Features:
- Designed for Single Basin installation
 - Made with solid timber from sustainably managed forests
 - Wall brackets included
 - Soft-close runners
 - Compatible with TONO Countertop Basins
 - Compatible with TONO Countertop Bottle Trap Set

Finishes:

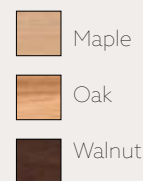

TONO Elements: Furniture

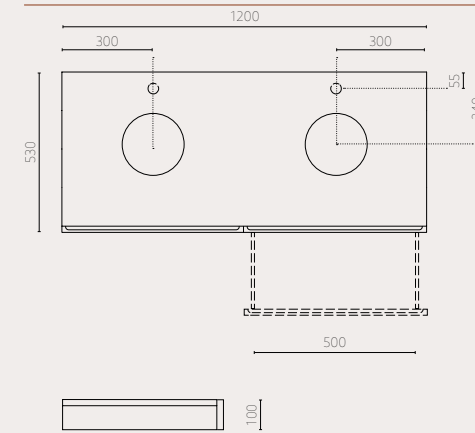
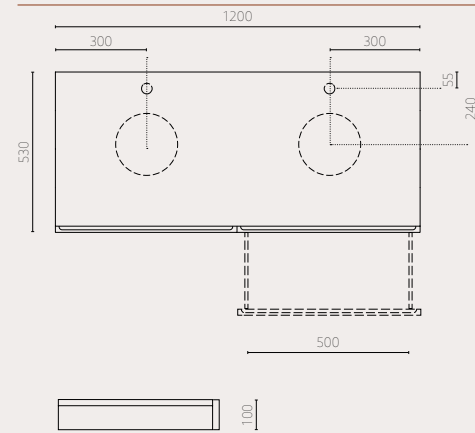
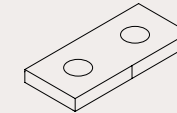
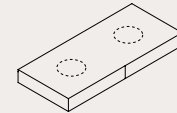

Wall Hung Drawer 1200 × 100 – Single Basin

- Features:
- Designed for Single Basin installation
 - Left and right versions available
 - Made with solid timber from sustainably managed forests
 - Wall brackets included
 - Soft-close runners
 - Compatible with TONO Countertop Basins
 - Compatible with TONO Countertop Bottle Trap Set

Allows for seated dresser configurations

Finishes:

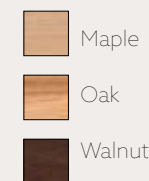

Wall Hung Drawer 1200 × 100 – Double Basin

- Features:
- Designed for Double Basin installation
 - Made with solid timber from sustainably managed forests
 - Wall brackets included
 - Soft-close runners
 - Compatible with TONO Countertop Basins
 - Compatible with TONO Countertop Bottle Trap Set

Allows for seated dresser configurations

Finishes:

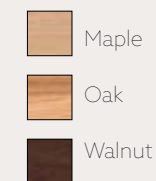

TONO Elements: Drawers

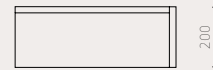
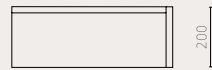
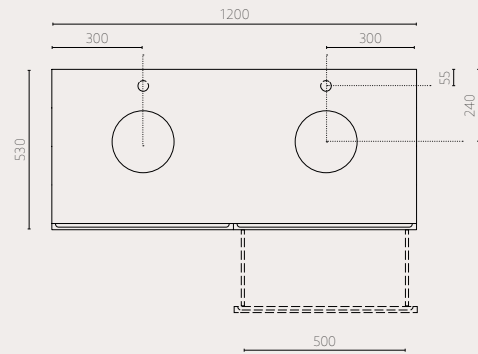
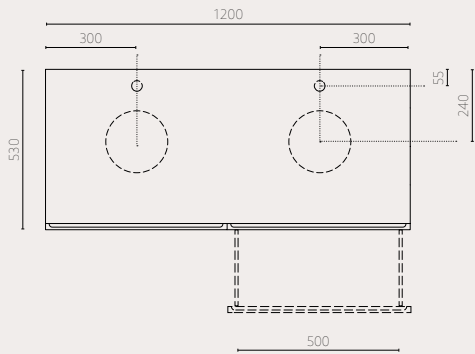
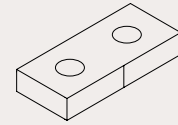
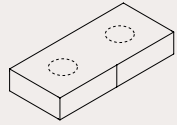

Wall Hung Drawer 1200 × 200 – Single Basin

Features:
Designed for Single Basin installation
Left and right versions available
Made with solid timber from sustainably managed forests
Wall brackets included
Soft-close runners
Compatible with TONO Countertop Basins
Compatible with TONO Countertop Bottle Trap Set

Wall Hung Drawer 1200 × 200 – Double Basin

Features:
Designed for Double Basin installation
Made with solid timber from sustainably managed forests
Wall brackets included
Soft-close runners
Compatible with TONO Countertop Basins
Compatible with TONO Countertop Bottle Trap Set

Finishes:

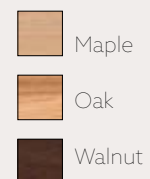

Finishes:

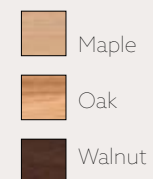

TONO Elements: Drawers

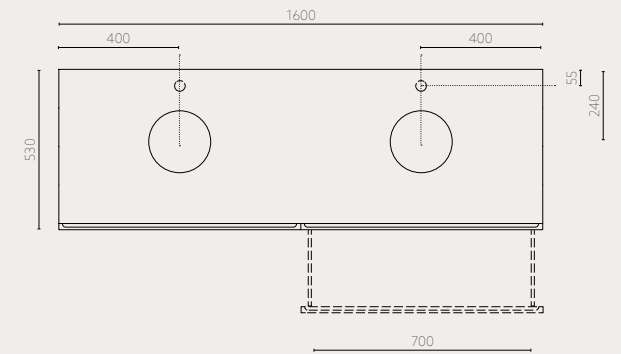
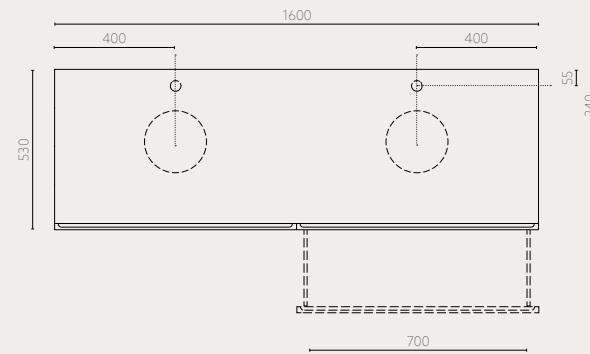
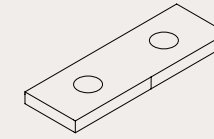
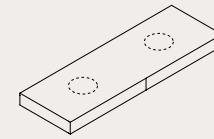

Wall Hung Drawer 1600 × 100 – Single Basin

Features:
Designed for Single Basin installation
Left and right versions available
Made with solid timber from sustainably managed forests
Wall brackets included
Soft-close runners
Compatible with TONO Countertop Basins
Compatible with TONO Countertop Bottle Trap Set

Allows for seated dresser configurations

Wall Hung Drawer 1600 × 100 – Double Basin

Features:
Designed for Double Basin installation
Made with solid timber from sustainably managed forests
Wall brackets included
Soft-close runners
Compatible with TONO Countertop Basins
Compatible with TONO Countertop Bottle Trap Set

Allows for seated dresser configurations

Finishes:



Finishes:



TONO Elements: Drawers

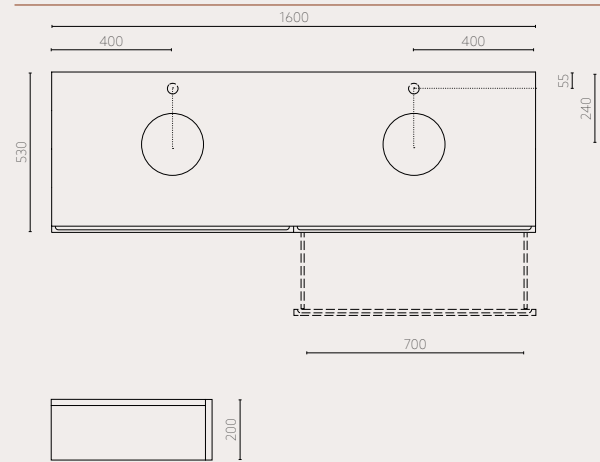
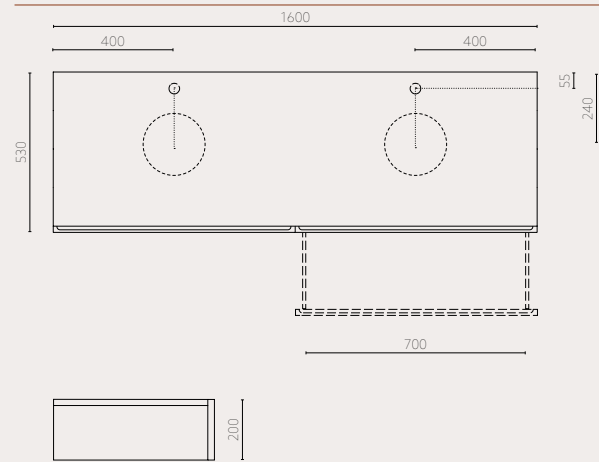
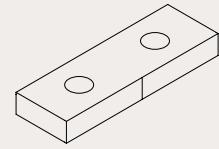
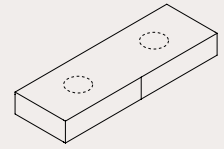

Wall Hung Drawer 1600 × 200 – Single Basin

- Features:
- Designed for Single Basin installation
 - Left and right versions available
 - Made with solid timber from sustainably managed forests
 - Wall brackets
 - Soft-close runners
 - Compatible with TONO Countertop Basins
 - Compatible with TONO Countertop Bottle Trap Set

Wall Hung Drawer 1600 × 200 – Double Basin

- Features:
- Designed for Double Basin installation
 - Made with solid timber from sustainably managed forests
 - Wall brackets
 - Soft-close runners
 - Compatible with TONO Countertop Basins
 - Compatible with TONO Countertop Bottle Trap Set

Finishes:

- Maple
- Oak
- Walnut

Finishes:

- Maple
- Oak
- Walnut

TONO Elements: Bench

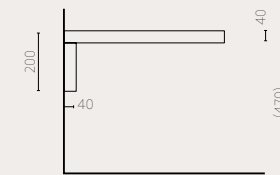
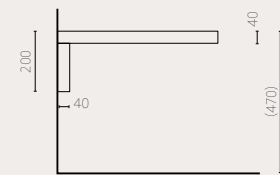
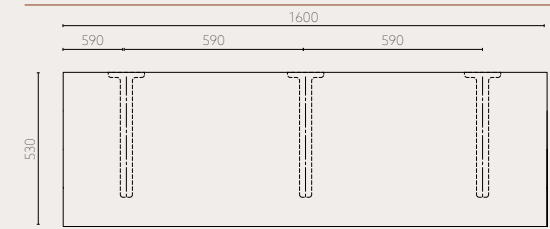
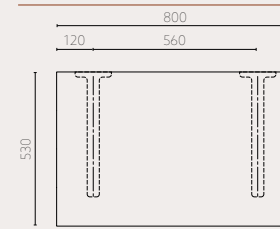
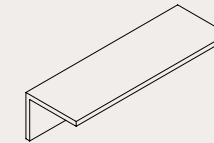
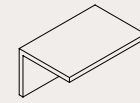

Wall Hung Bench 800

- Features:
- Made with solid timber from sustainably managed forests
 - Wall brackets

Wall Hung Bench 1600

- Features:
- Made with solid timber from sustainably managed forests
 - Wall brackets

Finishes:

- Maple
- Oak
- Walnut

Finishes:

- Maple
- Oak
- Walnut

TONO Elements: Mirrors

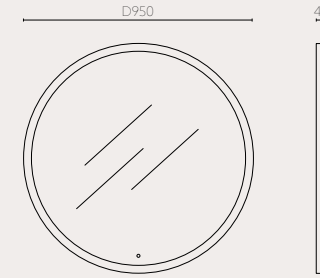
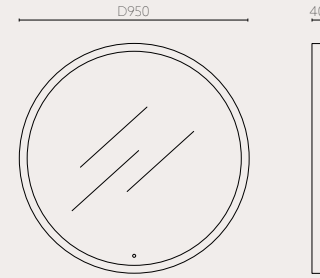
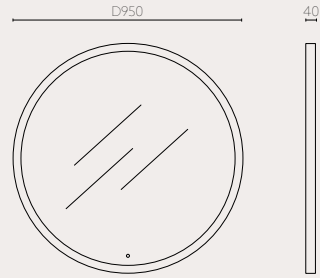

Krion Mirror D 950

Features:
100/240 V - 50/60 Hz 30W
IP 44 Electronics
IP 65 LED 3000°K
Integrated Mirror Demister
On/Off IR Sensor with timer

Timber Mirror D 950



Features:
100/240 V - 50/60 Hz 30W
IP 44 Electronics
IP 65 LED 3000°K
Integrated Mirror Demister
On/Off IR Sensor with timer
Made with solid timber from sustainably managed forests



Stone Mirror D 950

Features:
100/240 V - 50/60 Hz 30W
IP 44 Electronics
IP 65 LED 3000°K
Integrated Mirror Demister
On/Off IR Sensor with timer
Hand finished matt surface
Stone Protection coating to resist stains and bacteria

Note:
Stone is a natural product which may be subject to variations in shade. The colour of the material supplied may differ slightly from that shown

Finishes:
 Krion® Solid

Finishes:
 Maple
 Oak
 Walnut

Finishes:
 Habana Dark
 Capuccino Grey
 Calgary

TONO Elements: Mirrors

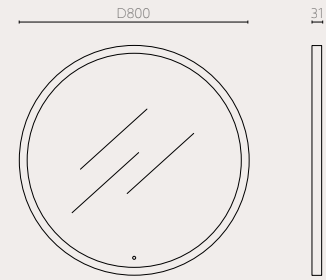
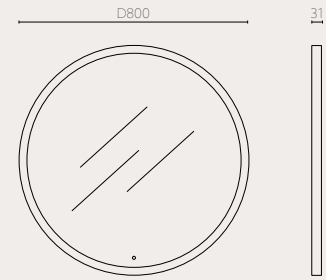

Mirror D 800

Features:
100/240 V - 50/60 Hz 30W
IP 44 Electronics
IP 65 LED 3000°K
Integrated Mirror Demister
On/Off IR Sensor with timer

Mirror D 800

Features:
100/240 V - 50/60 Hz 30W
IP 44 Electronics
IP 65 LED 3000°K
Integrated Mirror Demister
Controlled by tactile sensor

Finishes:



Finishes:



TONO Elements: Mirrors

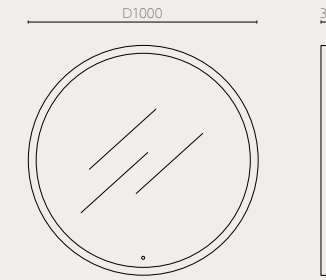
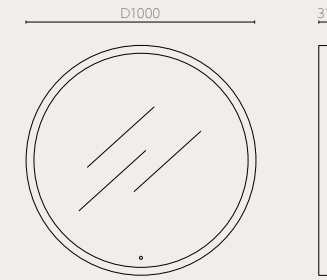

Mirror D 1000

Features:
100/240 V - 50/60 Hz 30W
IP 44 Electronics
IP 65 LED 3000°K
Integrated Mirror Demister
On/Off IR Sensor with timer
Possibility of installing magnifying mirror

Mirror D 1000

Features:
100/240 V - 50/60 Hz 30W
IP 44 Electronics
IP 65 LED 3000°K
Integrated Mirror Demister
Controlled by tactile sensor
Possibility of installing magnifying mirror

Finishes:



Finishes:



TONO Elements: Mirrors

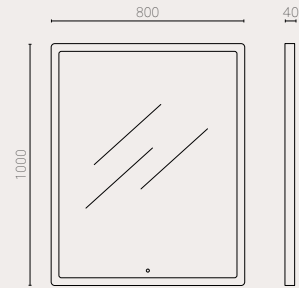
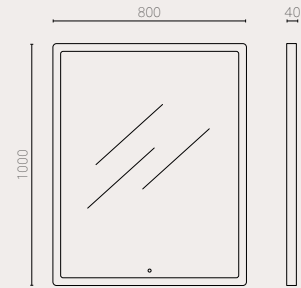



Krion Mirror 800 × 1000

Features:
100/240 V – 50/60 Hz 40W
IP 44 Electronics
IP 65 LED 3000°K
Integrated Mirror Demister
On/Off IR Sensor with timer

Timber Mirror 800 × 1000

Features:
100/240 V – 50/60 Hz 40W
IP 44 Electronics
IP 65 LED 3000°K
Integrated Mirror Demister
On/Off IR Sensor with timer
Made with solid timber from sustainably managed forests

Finishes:
 Krion®Solid

Finishes:
 Maple
 Oak
 Walnut

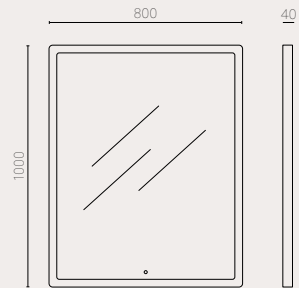

TONO Elements: Mirrors



Stone Mirror 800 × 1000

Features:
100/240 V – 50/60 Hz 30W
IP 44 Electronics
IP 65 LED 3000°K
Integrated Mirror Demister
On/Off IR Sensor with timer
Hand finished matt surface
Stone Protection coating to resist stains and bacteria

Note:
Stone is a natural product which may be subject to variations in shade. The colour of the material supplied may differ slightly from that shown

Finishes:
 Habana Dark
 Capuccino Grey
 Calgary

TONO Elements: Mirrors

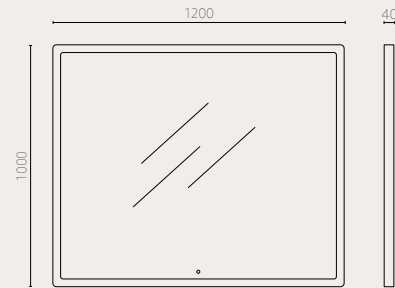
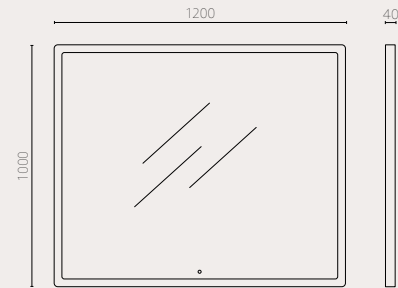
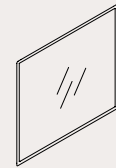

TONO Elements: Mirrors

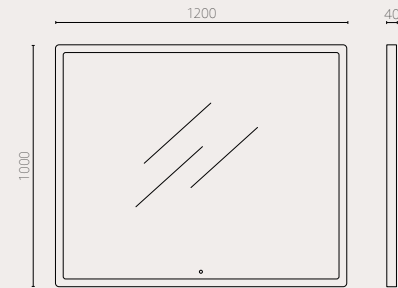

Krion Mirror 1200 × 1000

Features:
100/240 V – 50/60 Hz 60W
IP 44 Electronics
IP 65 LED 3000°K
Integrated Mirror Demister
On/Off IR Sensor with timer

Finishes:



Krion®Solid

Timber Mirror 1200 × 1000

Features:
100/240 V – 50/60 Hz 60W
IP 44 Electronics
IP 65 LED 3000°K
Integrated Mirror Demister
On/Off IR Sensor with timer
Made with solid timber from sustainably managed forests

Finishes:



Maple



Oak



Walnut

Stone Mirror 1200 × 1000

Features:
100/240 V – 50/60 Hz 60W
IP 44 Electronics
IP 65 LED 3000°K
Integrated Mirror Demister
On/Off IR Sensor with timer
Hand finished matt surface
Stone Protection coating to resist stains and bacteria

Note:

Stone is a natural product which may be subject to variations in shade. The colour of the material supplied may differ slightly from that shown

Finishes:



Habana Dark



Capuccino Grey



Calgary

TONO Elements: Mirrors

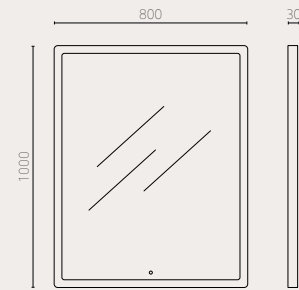
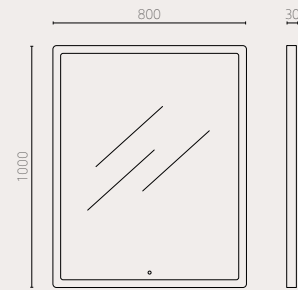

Mirror 800 x 1000

- Features:
- 100/240 V - 50/60 Hz 30W
 - IP 44 Electronics
 - IP 65 LED 3000°K
 - Integrated Mirror Demister
 - On/Off IR Sensor with timer
 - Possibility of installing magnifying mirror

Mirror 800 x 1000

- Features:
- 100/240 V - 50/60 Hz 30W
 - IP 44 Electronics
 - IP 65 LED 3000°K
 - Integrated Mirror Demister
 - Controlled by tactile sensor
 - Possibility of installing magnifying mirror

Finishes:



Mirror

Finishes:



Mirror

TONO Elements: Mirrors

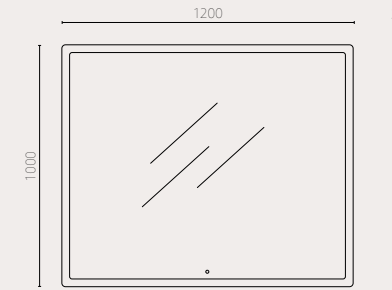
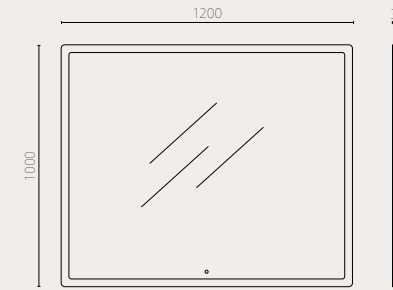

Mirror 1200 x 1000

- Features:
- 100/240 V - 50/60 Hz 30W
 - IP 44 Electronics
 - IP 65 LED 3000°K
 - Integrated Mirror Demister
 - On/Off IR Sensor with timer
 - Possibility of installing magnifying mirror

Mirror 1200 x 1000

- Features:
- 100/240 V - 50/60 Hz 30W
 - IP 44 Electronics
 - IP 65 LED 3000°K
 - Integrated Mirror Demister
 - Controlled by tactile sensor
 - Possibility of installing magnifying mirror

Finishes:



Mirror

Finishes:



Mirror

TONO Elements: Mirrors

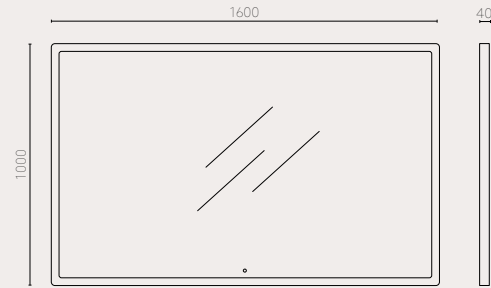
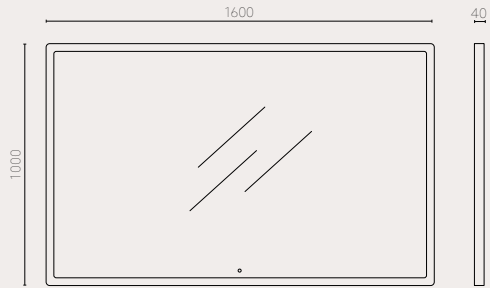
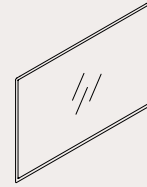
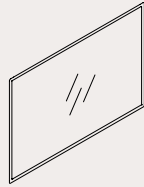

TONO Elements: Mirrors

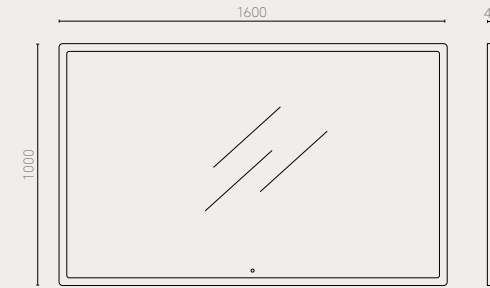
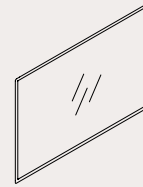

Krion Mirror 1600 × 1000

Features:
100/240 V - 50/60 Hz 80W
IP 44 Electronics
IP 65 LED 3000°K
Integrated Mirror Demister
On/Off IR Sensor with timer

Timber Mirror 1600 × 1000



Features:
100/240 V - 50/60 Hz 80W
IP 44 Electronics
IP 65 LED 3000°K
Integrated Mirror Demister
On/Off IR Sensor with timer
Made with solid timber from sustainably managed forests



Stone Mirror 1600 × 1000

Features:
100/240 V - 50/60 Hz 80W
IP 44 Electronics
IP 65 LED 3000°K
Integrated Mirror Demister
On/Off IR Sensor with timer
Hand finished matt surface
Stone Protection coating to resist stains and bacteria

Note:
Stone is a natural product which may be subject to variations in shade. The colour of the material supplied may differ slightly from that shown

Finishes:
 Krion® Solid

Finishes:
 Maple
 Oak
 Walnut

Finishes:
 Habana Dark
 Capuccino Grey
 Calgary

TONO Elements: Accessories

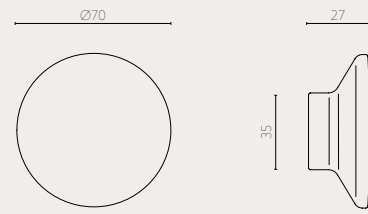
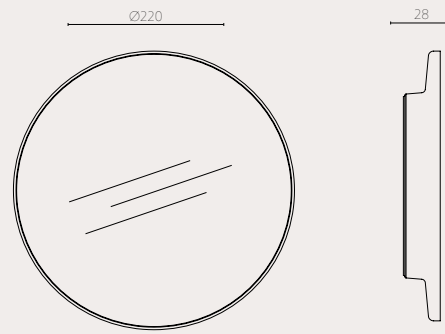

Magnifying mirror

- Features:
- 3x Magnifying mirror
- Aluminum frame
- Magnetig support

Towel Hook

- Features:
- Wall Mounted fixings
- Ni-Cr coating tested to EN 248

- Finishes:
- Chrome

- Finishes:
- Chrome
 - Dark Chrome
 - Copper

TONO Elements: Accessories

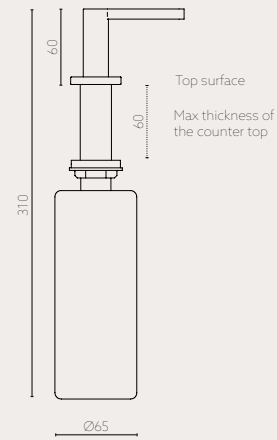

Soap Dispenser

- Features:
- Countertop installation
- Anti-theft system
- Soap refill from top or bottom
- Ni-Cr coating tested to EN 248

- Finishes:
- Chrome

TONO Elements: Accessories

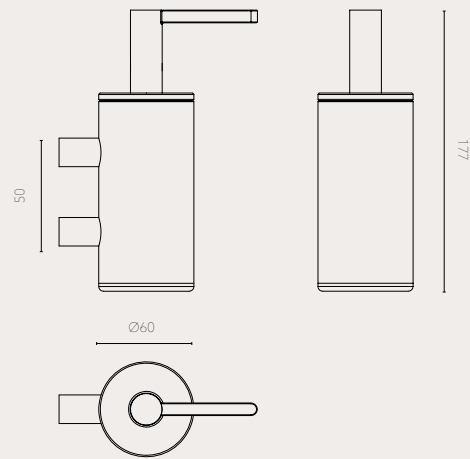
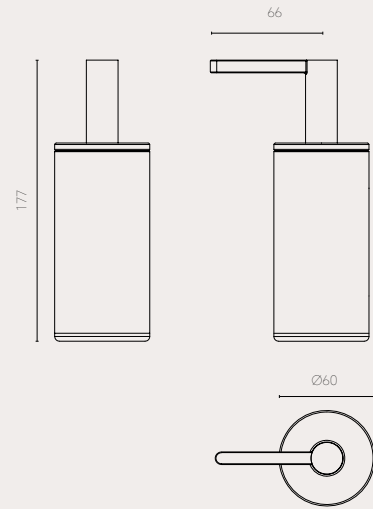
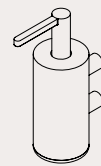
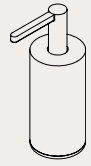

Soap Dispenser

Features:
Free standing
Capacity 200 ml.

Soap Dispenser

Features:
Wall mounted
Capacity 200 ml.

Finishes:
 Chrome

Finishes:
 Chrome

TONO Elements: Accessories

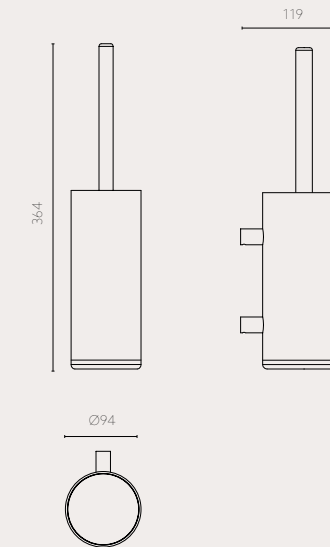
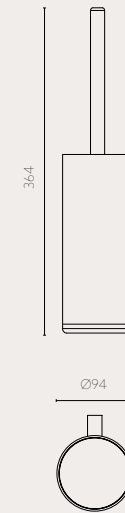
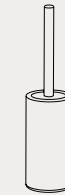
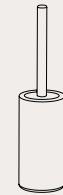

Brush holder

Free standing

Brush Holder

Wall Mounted

Finishes:
 Chrome

Finishes:
 Chrome

TONO Elements: Sanitaryware

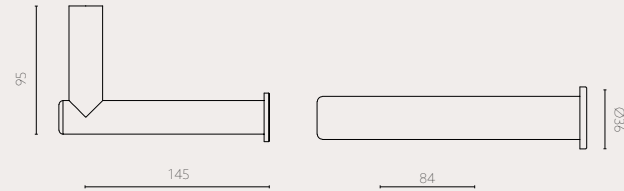
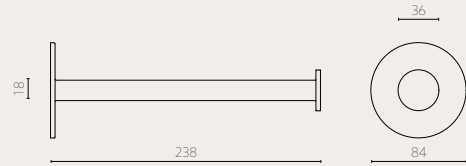
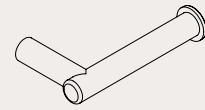

Toilet Roll Holder

Related items:
Wall Mounted Toilet

Toilet Roll Holder Without Cover

Related items:
Wall Mounted Toilet

Finishes:
 Chrome

Finishes:
 Chrome

TONO Elements: Accessories

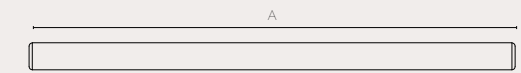
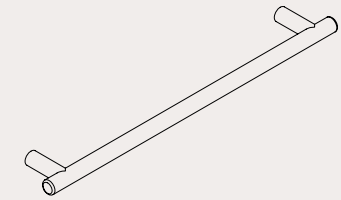
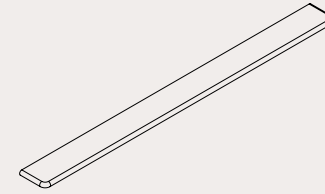

Shower Shelf

Features:
Wall Mounted fixings
Ni-Cr coating tested to EN 248

Towel Rail

Features:
45 - 60 - 80 cm Towel Rail
Ni-Cr coating tested to EN 248

Finishes:
 Chrome

Finishes:
 Chrome

TONO Elements: Towel Warmer

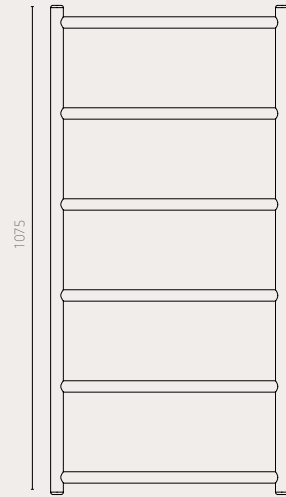
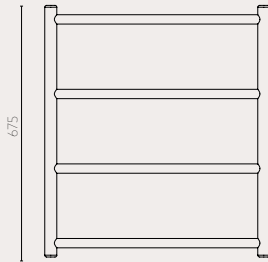
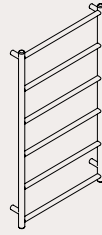
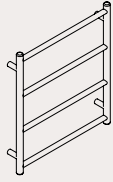

Towel Warmer 600 x 675

Features:

Corrosion Resistance
Stainless Steel Aisi 304
Tubular Design

Finishes:

 Polished steel
 Brushed steel

Towel Warmer 600 x 1075

Features:

Corrosion Resistance
Stainless Steel Aisi 304
Tubular Design

Finishes:

 Polished steel
 Brushed steel

Natural Stone

All products in the TONO range are precision-manufactured and finished by hand to achieve their distinctive satin appearance. TONO One and TONO Elements are available in limestone or different types of marble, as follows:

Habana Dark
(European marble, with big colour variations among items)
Bulk density
UNE EN 1936:2007 2640 Kg/m³

Capuccino Grey
(Asian marble, with big colour variations among items)
Bulk density
UNE EN 1936:2007 2818 Kg/m³

Calgary
(Asian limestone, with slight colour changes among items)
Bulk density
UNE EN 1936:2007 2200 Kg/m³

Product protection

Each item in the TONO range is given a specific treatment to enhance the characteristics of the material and to protect it from external agents. PORCELANOSA uses a high-quality water and oil-based repellent sealer that protects the stone from moisture, saltpetre and other household stains. It also enhances the natural colour of the stone.

No two natural products are exactly alike. The subtle differences between each item make them unique and impossible to replicate.

Care and Maintenance

For ordinary cleaning, a powerful cleaner with a neutral pH should be used. This gives fast, efficient results, without affecting the product's protective treatment. Dilute a capful of stone cleaner in a bucket of warm water and mop the product. It's not necessary to rinse it afterwards with water.

In the event of stains or marks caused by acidic substances (lemon, cola, tomato juice, lime-scale remover, wine, vinegar, etc) these can be removed using a suitable restoration kit, available from L'Antic Colonial sale points.

To remove organic stains, dyes and felt-tip pen, use a specific stain remover for stone.

To renew or increase the shine of TONO stoneware, use a natural wax specifically for stone. To apply, dilute the wax as required, rub it onto the surface and, after a few hours, gently wipe off with a soft cloth to obtain the required shine.

Natural Wood

All TONO Elements made of wood are crafted using selected species of trees from sustainably managed forests. All oak is from Europe, and all walnut and maple from North America.

Product protection

All TONO natural wood products come specially protected with a highly effective microporous blend of plant oils and waxes. This treatment has a high mechanical and chemical resistance, and conserves the wood's natural appeal while improving its durability and resilience. Dirt and water repellent, it's resistant to wine, beer, cola, coffee, tea, fruit juice and milk stains, in accordance with DIN 68861-1A.

Care and Maintenance

To remove dust, grease stains or fingerprints, dissolve mild soap in a container of warm water. Wipe the furniture with a damp cloth, and then dry all the surfaces, especially the corners, with a soft clean dry cloth. When cleaning the products, never use sharp objects, rough scouring pads, solvents, bleach, nail polish remover, vinegar, citric acid, abrasive products or polishes. Avoid using aggressive all-purpose cleaners. The protective surface can be renewed at any time without having to sand it first by applying a new layer of the oil/wax-based treatment recommended by PORCELANOSA.

Sanitaryware

Sanitaryware from the TONO One and TONO Elements ranges is made of Noken Ceramic®. This is comprised of a specific formula containing clay, kaolin, feldspar and quartz.

Using only the finest raw materials and temperatures of 1520°C, a pure white colour and superior physical properties can be achieved. These include a very compact material, higher impact resistance and greater flatness. The chemical formula of Noken Ceramic® and its glaze give TONO sanitaryware a scratch-proof, hypo-allergenic, vitrified surface with no pores. It's also resistant to thermal shock.

Care and Maintenance

To clean and care for TONO sanitaryware:

Clean the external parts with water and soft soap (preferably liquid), using a non-abrasive damp cloth. Clean the internal parts (inside the toilet pan) with a disinfectant soap detergent, using a soft sponge.

Always try to avoid granulated soaps, abrasive cosmetic products, cosmetic liquids or similar, and abrasive sponges. When cleaning the inside of the cistern, avoid using chemical products that might damage the internal components and mechanism.

Do not throw large amounts of toilet paper down the toilet, or products that might clog the siphon.

Avoid detergents with hydrofluoric acid. This attacks the glaze, causing porosities that will affect the product's appearance.

Krion® bath

KRION® is a latest-generation solid surface developed by PORCELANOSA. It's made of two-thirds natural minerals (ATH – aluminium trihydride) and a low percentage of high-resistance resins.

KRION® is a fully recyclable sustainable material. All products made of KRION® can be reprocessed and re-used. KRION® does not release volatile compounds, in keeping with PORCELANOSA's environmental commitments. KRION® is easily repairable and can be restored to its original appearance, significantly increasing its lifetime and reducing the need to replace it. In this way, it meets international environmental guidelines on durability.

Thanks to its properties and constant efforts in the field of development, KRION® has been awarded key environmental certificates such as Greenguard, Greenguard Gold and REACH.



Care and Maintenance

To clean an item made of KRION®, use a white fibre sponge and mildly abrasive cleaning product (powder cleaner). Rub it in gently, using circular movements, and then rinse it with plenty of water. To clean more stubborn stains, use a blue fibre sponge.

Do not use products that contain organic solvents (alcohol, acetone, ammonia, and fragrant compounds) or aggressive cleaning products such as bleach, hydrochloric acid, caustic soda, lime-scale remover or detergents containing anionic surfactants.

Brassware

TONO Brassware has been designed, developed and manufactured according to the highest standards. PORCELANOSA chooses only the finest raw materials and components, using internationally-accepted alloys and certified internal parts.

TONO bodies are made of brass. Strict attention is paid to all parts directly in contact with water, particularly those subject to drinking water regulations. Chrome and PVD finishes guarantee both resistance to wear and tear and a beautiful appearance.

The durability of PORCELANOSA cartridges is tested to more than twice the relevant requirements, guaranteeing reliability and smooth performance.

Since bathrooms are places where a good deal of water is consumed, environmental awareness is a key priority in the manufacture of TONO products. PORCELANOSA applies cutting-edge technologies to the manufacture of its mixers and showers, in order to reduce water consumption and save energy.

Care and Maintenance

For regular cleaning, use only warm soapy water. If this is not possible, use soft non-abrasive gels or similar cleaning products. Rinse them away thoroughly afterwards and polish with a soft cloth. Avoid using abrasive products such as scouring powder or products containing phosphoric acid, hydrochloric acid, formic acid or acetic acid, as these might badly damage the product. Only use cleaning products with a neutral pH. After cleaning or using brassware, dry it to prevent lime scale.

Acrylic

PORCELANOSA acrylic bathtubs have a warm smooth surface that feels comfortable to the touch. They are excellent at retaining heat compared to bathtubs made of other materials. PORCELANOSA acrylic has the strength, durability and toughness to withstand frequent use. It's resistant to everyday wear and tear, staining and superficial scratches, and is also antibacterial.

Owing to its low weight, PORCELANOSA acrylic is easy to install, helping to reduce transportation costs and allowing savings to be made on structural support.

Our cast acrylic sheets – made of poly-methyl methacrylate (PMMA) – can be recycled, converting them back to the original raw material.

Care and Maintenance

For regular cleaning, use only warm soapy water. If this is not possible, use soft non-abrasive gels or similar cleaning products. Rinse them away thoroughly afterwards and polish with a soft cloth. Avoid using abrasive products such as scouring powder or products containing phosphoric acid, hydrochloric acid, formic acid or acetic acid, as these might badly damage the product. Only use cleaning products with a neutral pH. After cleaning or using acrylic, dry it to prevent lime scale.

Foster + Partners and Porcelanosa

Foster + Partners is a global architecture, engineering and design studio, characterised by its integrated approach to design. Together with Porcelanosa, a global bathroom manufacturer with expertise across a wide range of products and materials, it has created a comprehensive and co-ordinated range of bathroom products that could be used in a multitude of settings, from residential to commercial interiors and everything in between.

The result of this ambitious project is TONO Elements and TONO One – a set of components designed to work together as part of an integrated system, with a wide choice of finishes and materials. Unified by a common, simple design language and palette of complementary materials and colour tones, the minimalist aesthetic brings to the fore an honesty of material, simplicity of form and the craft of manufacture.

The PORCELANOSA GROUP is present
in around 100 countries

Today, the PORCELANOSA GROUP
is a benchmark company in the
national and international market,
founded on values such as innovation
and quality but, above all, based on
confidence in its extensive workforce
of almost 5,000 people and attention
to the social environment.

With over 40 years of experience,
PORCELANOSA GROUP is present in
around 100 countries worldwide, due
to its unique business model, which
supports a strong corporate strategy.
It is currently one of the Spanish
companies with worldwide recognition,
according to a report published by the
consultants PricewaterhouseCooper
and the Financial Times.

Manufacturing diversification has
been the mainstay in corporate
expansion which started exclusively
with the manufacture of tiles. Currently,
the eight companies of the Group offer
an extensive range of products which
include kitchen and bathroom designs
and advanced construction solutions
for contemporary architecture.



PORCELANOSA Grupo