

CABINA  
**BREAK**  
WALK-IN CLOSET



Capiente, funzionale e componibile, la cabina armadio Break può essere attrezzata con moduli angolari, luci led retro ripiani, cassetti in vetro fumé, tubi appendiabiti e accessori in finitura brunita. Il sistema a cremagliera, eliminando i fianchi di sostegno, risulta essere visivamente molto leggero.

*Capacious, functional and modular, the Break walk-in closet can be fitted with corner modules, LED lighting on the back of shelves, smoked glass drawers, hanging rails and accessories in bronze finish. The slotted rail system does away with the need for supporting side panels and hence gives a visually light appearance.*

Caratteristiche tecniche / Technical features	p. 03
Modularità / Module size	p. 04
Accessori / Equipment	p. 06
Illuminazione / Lighting	p. 09

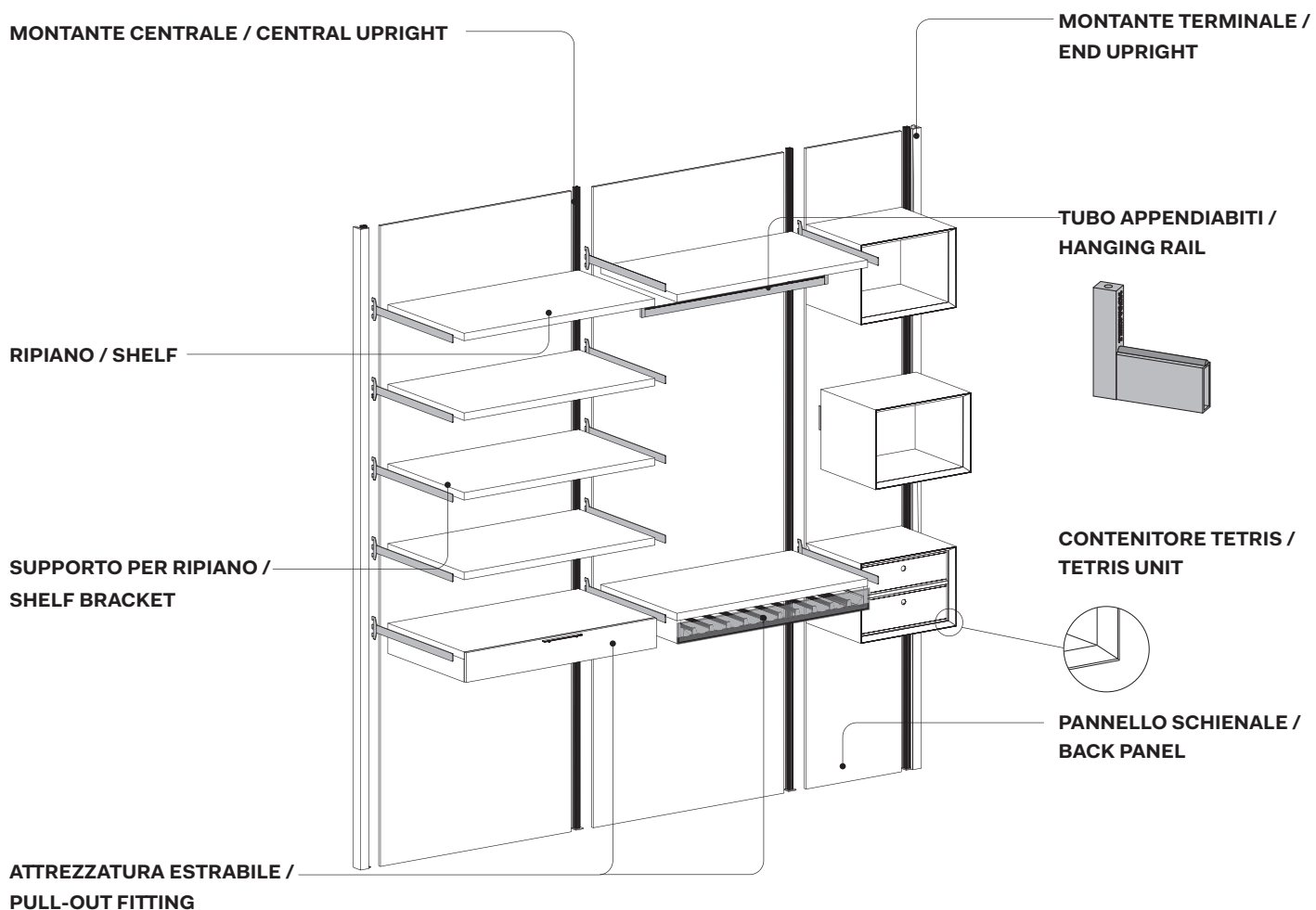

## Regolazione / Adjustment

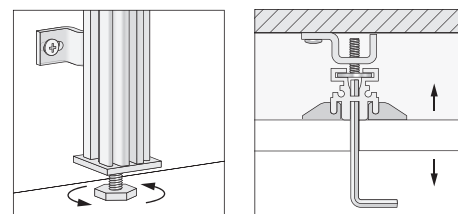

## Note per la sicurezza / Notes on safety

Per motivi di sicurezza il fissaggio a parete dei montanti va fatto con opportuni tasselli in funzione del tipo di muratura, per questo motivo i tasselli non sono forniti.

*For safety reasons, uprights must be fastened to the wall using appropriate anchors to suit the type of wall in question, which is why the anchors are not provided.*

## MODULARITÀ / MODULE SIZE

### ALTEZZA / HEIGHT

### LARGHEZZA / WIDTH

Pannelli per angolo /  
Panels for corners

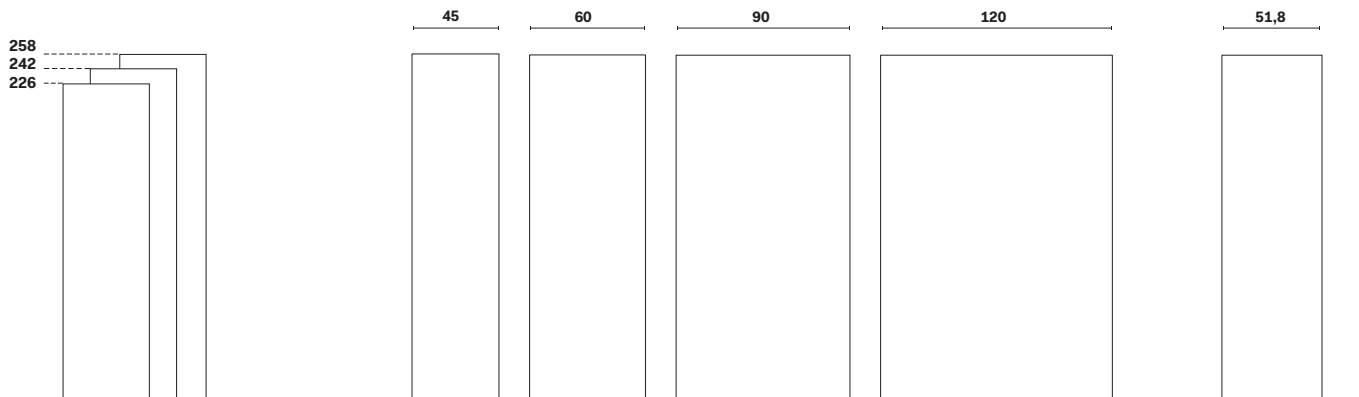

### PROFONDITÀ / DEPTH

**Distanza del pannello dal muro**  
*Distance of panel from wall*

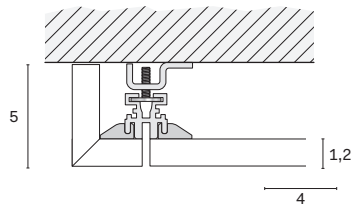

**Distanza del pannello con specchio dal muro**  
*Distance of panel with mirror from wall*

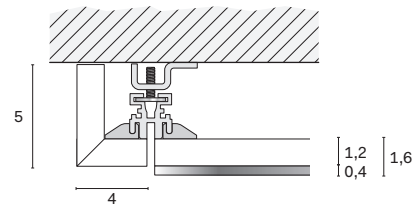

Ripiani / Shelves

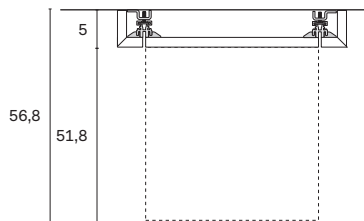

Ripiani retroilluminati / Backlit shelves

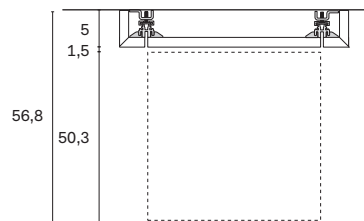

Accessori sospesi / Suspended accessories

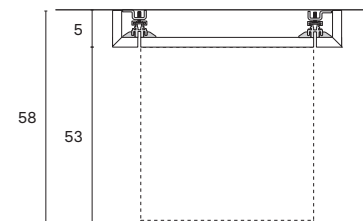

### ANGOLO / CORNER

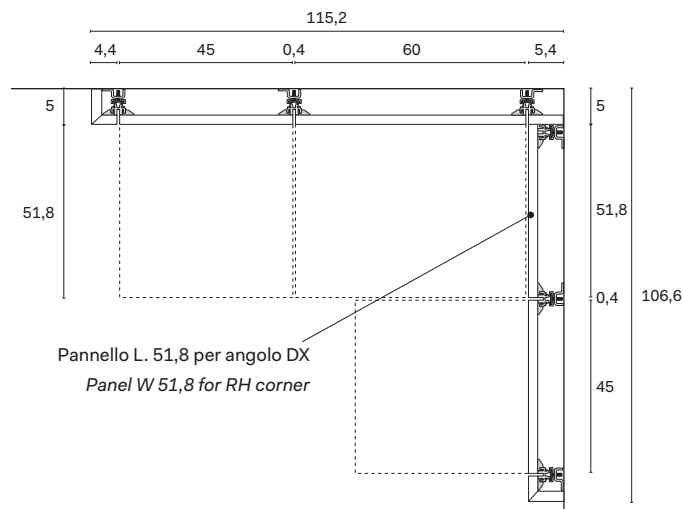

## UTILIZZO PANNELLI / USE OF PANELS

### ESEMPIO COMPOSIZIONI LINEARI / EXAMPLES OF LINEAR CONFIGURATIONS

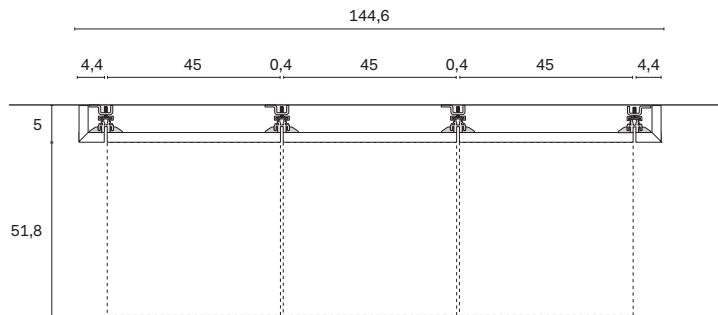

### ESEMPIO COMPOSIZIONI A "U" / EXAMPLES OF U-SHAPED CONFIGURATIONS

Ripiano standard con fissaggio frontale / Standard shelf fastened from the front



\* Ripiano con fissaggio da sopra / \* Shelf fastened from above



**Esempio 1 / Example 1**

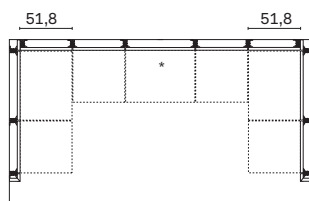

**Esempio 2 / Example 2**

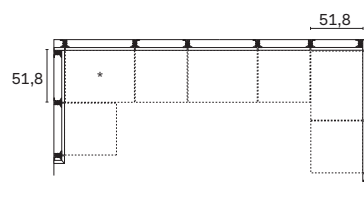

**Esempio 3 / Example 3**

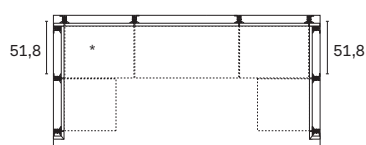

**Esempio 4 / Example 4**

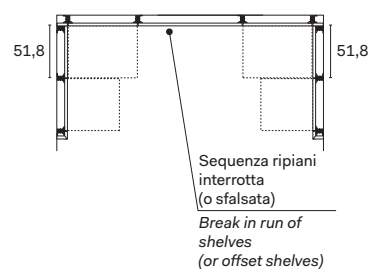

### Ripiani / Shelves

Sp. 3 cm / 3 cm thick

Prof. 51,8 cm / Depth 51,8 cm

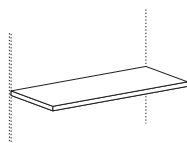

Larghezza / Width  
45-60-90-120

Con tubo appendiabito /  
With hanger rail

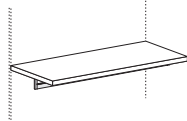

Larghezza / Width  
45-60-90-120

### Ripiani retroilluminati / Backlit shelves

Sp. 3 cm / 3 cm thick

Prof. 51,8 cm / Depth 51,8 cm

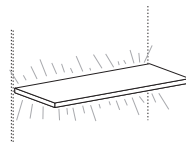

Larghezza / Width  
45-60-90-120

Con tubo appendiabito /  
With hanger rail

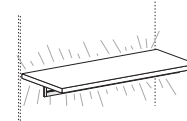

Larghezza / Width  
45-60-90-120

### Ripiani portascarpe / Shoe rack shelves

Sp. 1,2 cm in folding / Mitre-folded 1,2 cm thick

Prof. 48,7 cm / Depth 48,7 cm

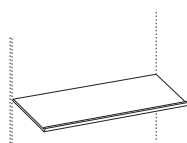

Larghezza / Width  
45-60-90

### Appendiabiti / Hangers

#### PLUS

Finitura brunito / Bronze finish

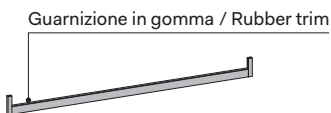

Tutte le larghezze / All widths

### Servetto appendiabiti / Clothes lift

#### Manuale / Manual

Finitura brunito / Bronze finish

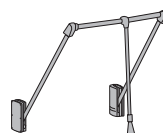

Larghezza / Width  
90-120

### Portasciarle / Scarf hanger

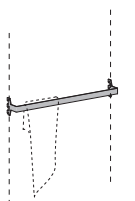

Larghezza / Width  
45-60-90-120

### Attrezzatura estraibile con frontale / Pull-out fittings with front

Altezza cassetto 5 cm / Drawer side 5 cm high.

#### Cassetto / Drawer

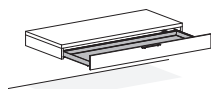

Larghezza / Width  
90-120

#### Porta pantaloni / Trousers rack

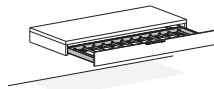

Larghezza / Width  
90-120

#### 2 cassetti / 2 drawers

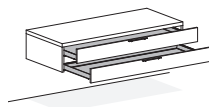

Larghezza / Width  
90-120

#### Cassetto e portapantaloni / Drawer and trousers rack

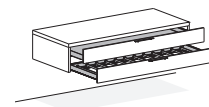

Larghezza / Width  
90-120

### Attrezzatura estraibile con frontale vetro / Pull-out fittings with glass front

Altezza cassetto 5 cm / Drawer side 5 cm high.

#### Cassetto / Drawer

Finitura brunito / Bronze finish

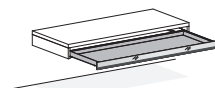

Larghezza / Width  
90-120

#### Porta pantaloni / Trousers rack

Finitura brunito / Bronze finish

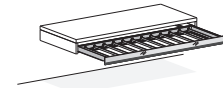

Larghezza / Width  
90-120

#### 2 cassetti / 2 drawers

Finitura brunito / Bronze finish

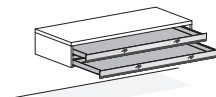

Larghezza / Width  
90-120

#### Cassetto e portapantaloni / Drawer and trousers rack

Finitura brunito / Bronze finish

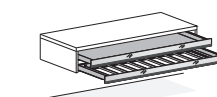

Larghezza / Width  
90-120

### Cassettiere / Drawers

Altezza cassetto 11 cm / Drawer side 11 cm high.

#### Cassetto / Drawer

sospeso / suspended

a terra / floorstanding

in appoggio / sit-on top

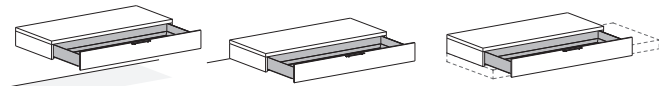

Larghezza / Width  
90-120

#### 2 cassetti / 2 drawers

sospeso / suspended

a terra / floorstanding

in appoggio / sit-on top



Larghezza / Width  
90-120

### Vassoi in folding / Mitre-folded trays

In folding sp. 0,8 cm / Mitre-folded 0,8 cm thick

Altezza 5 cm / Height 5 cm

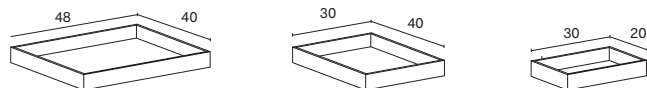

### Combinazioni possibili / Possible combinations

Per cassetto L. 90 cm  
/ For drawer W 90 cm



Per cassetto L. 120 cm  
/ For drawer W 120 cm



### Vaschette interne / Tray inserts

In 03Z Similpelle / In 03Z Leatherette

Altezza 5 cm / Height 5 cm

porta oggetti /  
tidy tray

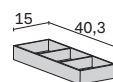

porta cravatte /  
tie organizer

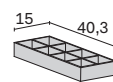

porta anelli /  
ring organizer

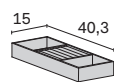

porta orologi /  
watch organizer

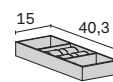

## ACCESSORI / EQUIPMENT

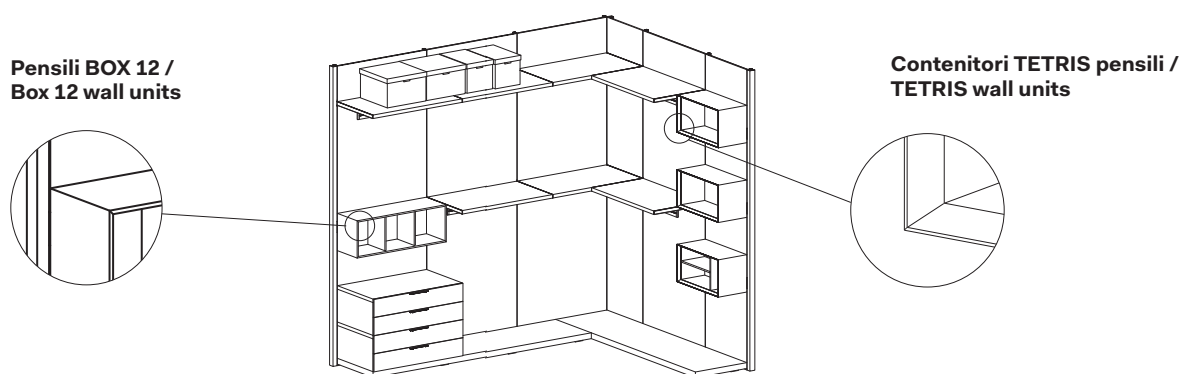

### Contenitori TETRIS pensili / suspended TETRIS units

Prof. 28,7 - 37,4 cm / Depth 28,7 - 37,4 cm

Alt. 32 cm / Height 32 cm

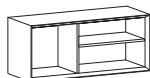
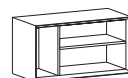
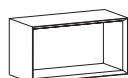
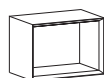

Larghezza / Width  
45

Larghezza / Width  
60

Larghezza / Width  
90

### Contenitori TETRIS in appoggio / Sit-on-top TETRIS units

Prof. 51,8 cm / Depth 51,8 cm

Alt. 16 cm / Height 16 cm

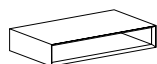

Larghezza / Width  
90 - 120

### BOX 12 pensili / suspended BOX 12 units

Prof. 28,7 - 37,4 cm / Depth 28,7 - 37,4 cm

Alt. 32 cm / Height 32 cm

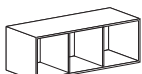

Larghezza / Width  
45

Larghezza / Width  
60

Larghezza / Width  
90



## ILLUMINAZIONE / LIGHTING

24V 3000K

### Luci LED orizzontali / Horizontal LED lights per ripiani / for shelves

Da completare con trasformatore ed eventuali accessori in base al sistema di accensione scelto.

*To be finished off with transformer and accessories, if any, based on the ON/OFF control system chosen.*

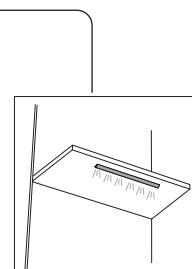

**Luci LED con e senza sensore/  
LED lights with or without sensor**

### Retroilluminazione / Backlighting per ripiani / for shelves

Da completare con trasformatore ed eventuali accessori in base al sistema di accensione scelto.

*To be finished off with transformer and accessories, if any, based on the ON/OFF control system chosen.*

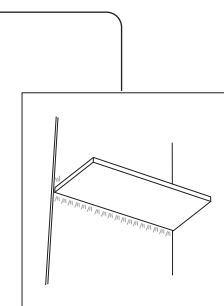
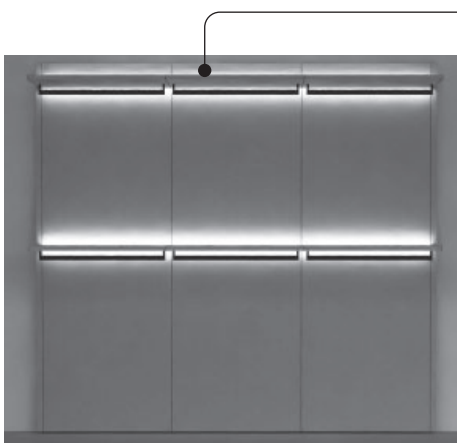

**Ripiano retroilluminato /  
Backlighting for shelf**

### Luci LED miste / mix of LED lights

Da completare con trasformatore ed eventuali accessori in base al sistema di accensione scelto.

*To be finished off with transformer and accessories, if any, based on the ON/OFF control system chosen.*

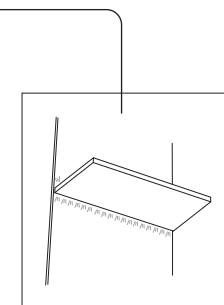
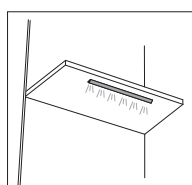

**Luci LED con e senza sensore/  
LED lights with or without sensor**

**Ripiano retroilluminato /  
Backlighting for shelf**