



Box 18 è un sistema di elementi contenitore, flessibile e moderno, studiato per organizzare e arredare la zona giorno. Componibile e versatile, è disponibile in molteplici soluzioni.

Box 18 è un sistema di elementi contenitore, flessibile e moderno, studiato per organizzare e arredare la zona giorno. Componibile e versatile, è disponibile in molteplici soluzioni.

NOVAMOBILI

BOX 18

CONTENITORI A TERRA CON PIEDINI H. 2,1 cm BASE STORAGE UNITS WITH LEVELLERS H 2,1 CM

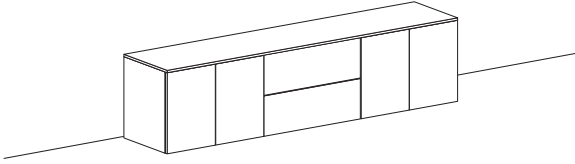

Per le riduzioni a misura possibili vedi pag.21
To verify which reductions are available see pag.21

Disponibile anche nella versione in appoggio senza piedini e sospesa.
They come also in different versions - sit-on-top or wall mounted.

ALTEZZE (in cm) HEIGHTS (cm)

In altezza va sempre aggiunto il top (vedi top pag. 7).
Always add the top to calculate the total height (see tops pag. 7).

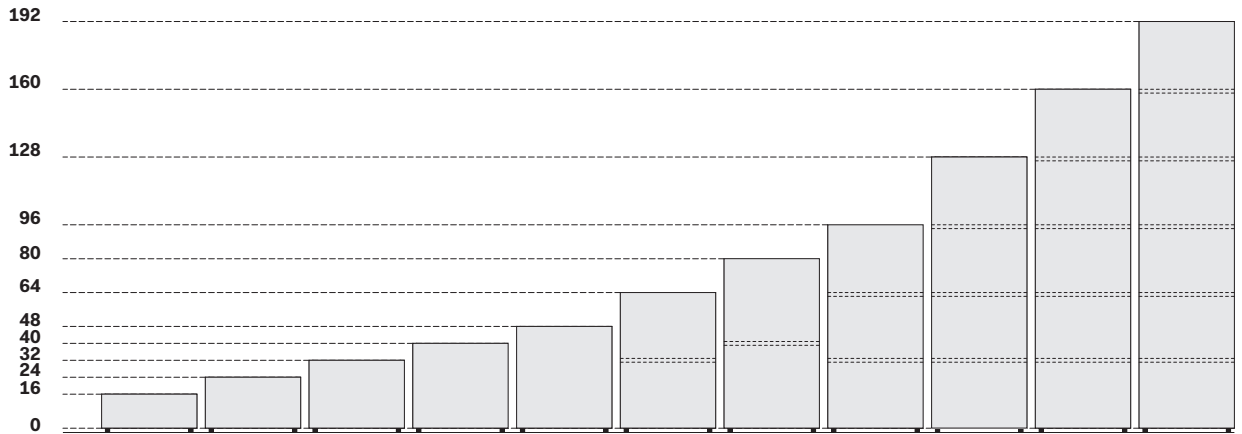

PROFONDITÀ (in cm) DEPTHS (cm)

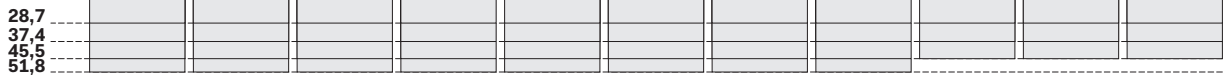

LARGHEZZE (in cm) WIDTHS (cm)

--	--	30	30	30	30	30	30	30	30	30	30
45	45	45	45	45	45	45	45	45	45	45	45
60	60	60	60	60	60	60	60	60	60	60	60
75	75	75	75	75	75	75	75	75	--	--	--
90	90	90	90	90	90	90	90	90	--	--	--
120	120	120	120	120	120	120	120	120	--	--	--
135	135	135	135	--	--	--	--	--	--	--	--
150	150	150	150	--	--	--	--	--	--	--	--

APERTURE DISPONIBILI PER CONTENITORI BASE ILLUSTRATION OF BASE STORAGE UNIT OPENING SYSTEMS

BATTENTE
HINGED

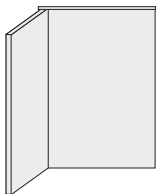

CASSETTONE
OVERSIZED DRAWER



RIBALTA
PULL-DOWN
DOOR

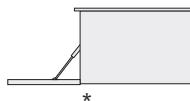

RIBALTA FILO
FILO PULL-DOWN
DOOR

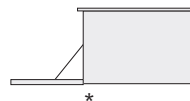

CASSETTI
DRAWERS

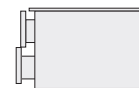

PORTACARTELLE
HANGING FOLDER
SYSTEM

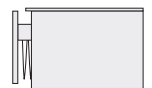

NOVAMOBILI

BOX 18

CONTENITORI A TERRA CON GOLA E PIEDINI H. 2,1 cm BASE STORAGE UNITS WITH PROFILE AND LEVELLERS H 2,1 CM

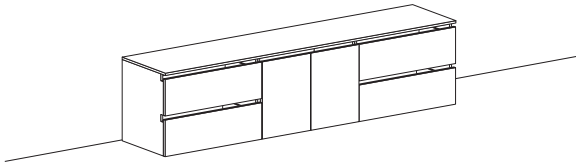

Per le riduzioni a misura possibili vedi pag.21
To verify which reductions are available see pag.21

Disponibile anche nella versione in appoggio senza piedini e sospesa.
They come also in different versions - sit-on-top or wall mounted.

ALTEZZE (in cm) HEIGHTS (cm)

In altezza va sempre aggiunto il top (vedi i top disponibili a pag. 7).

Always add the top to calculate the total height (see tops availables pag. 7).

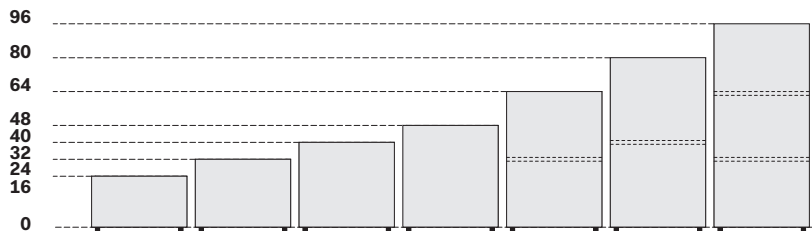

PROFONDITÀ (in cm) DEPTHS (cm)

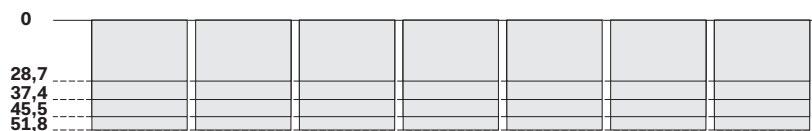

LARGHEZZE (in cm) WIDTHS (cm)

--	30	30	30	30	30	30
45	45	45	45	45	45	45
60	60	60	60	60	60	60
75	75	75	75	75	75	75
90	90	90	90	90	90	90
120	120	120	120	120	120	120
135	135	135	--	--	--	--
150	150	150	--	--	--	--

APERTURE DISPONIBILI PER CONTENITORI CON GOLA ILLUSTRATION OF GOLA BASE STORAGE UNIT OPENING SYSTEMS

BATTENTE
HINGED

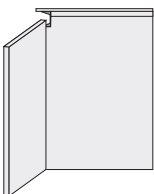

CASSETTONE
OVERSIZED DRAWER

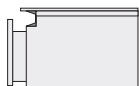

RIBALTA
PULL-DOWN DOOR

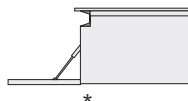

RIBALTA FILO
FILO PULL-DOWN DOOR

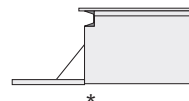

NOVAMOBILI

BOX 18

CONTENITORI SOSPESI

WALL UNITS

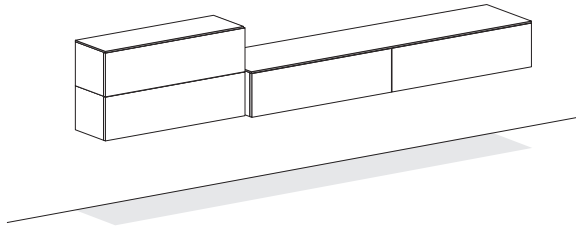

Per le riduzioni a misura possibili vedi pag.21
To verify which reductions are available see pag.21

ALTEZZE (in cm)

HEIGHTS (cm)

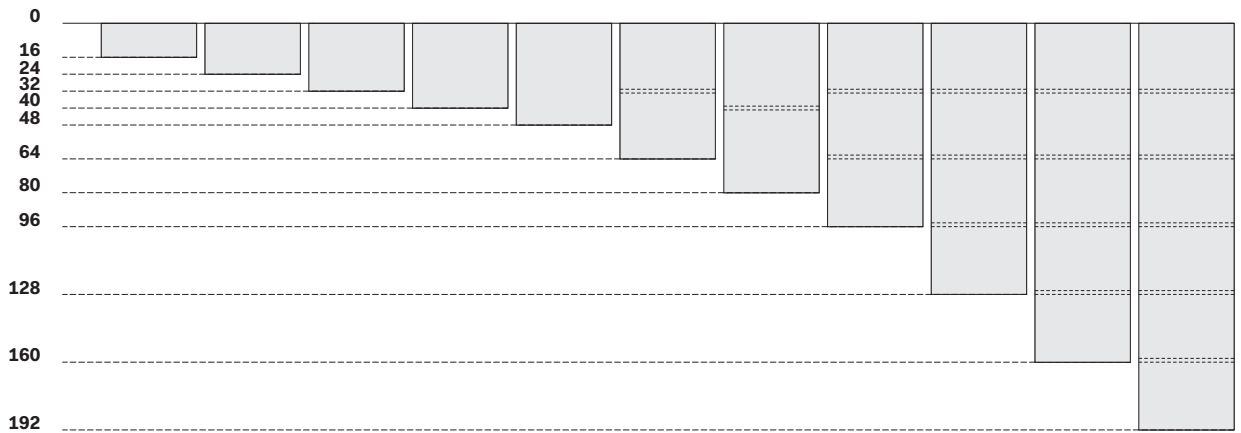

PROFONDITÀ (in cm)

DEPTHS (cm)

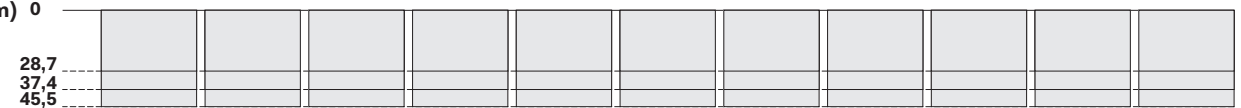

LARGHEZZE (in cm)

WIDTHS (cm)

--	--	30	30	30	30	30	30	30	30	30	30
45	45	45	45	45	45	45	45	45	45	45	45
60	60	60	60	60	60	60	60	60	60	60	60
75	75	75	75	75	75	--	--	--	--	--	--
90	90	90	90	90	90	--	--	--	--	--	--
120	120	120	120	120	120	--	--	--	--	--	--
135	135	135	135	135	--	--	--	--	--	--	--
150	150	150	150	150	--	--	--	--	--	--	--

APERTURE DISPONIBILI PER CONTENITORI SOSPESI

ILLUSTRATION OF WALL UNIT OPENING SYSTEMS

RIALZA
LIFT-UP



Posizione minima da terra suggerita:
145 cm con rialza H. 24 cm
135 cm con rialza H. 32/40 cm

Minimum recommended position above floor:
145 cm with H 24 cm lift-up door
135 cm with H 32/40 cm lift-up door

RIBALTA
PULL-DOWN
DOOR



Posizione massima da terra suggerita:
143 cm con ribalta H. 24
135 cm con ribalta H. 32
127 cm con ribalta H. 40

Maximum recommended position above floor:
143 cm with H 24 pull-down door
135 cm with H 32 pull-down door
127 cm with H 40 pull-down door

RIBALTA FILO
FILO PULL-DOWN
DOOR

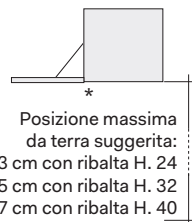

Posizione massima da terra suggerita:
143 cm con ribalta H. 24
135 cm con ribalta H. 32
127 cm con ribalta H. 40

Maximum recommended position above floor:
143 cm with H 24 pull-down door
135 cm with H 32 pull-down door
127 cm with H 40 pull-down door

BATTENTE
HINGED

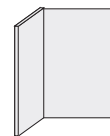

CASSETTI
DRAWERS

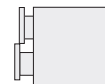

BOX 18

FRONTALI PER CONTENITORI FRONTS FOR STORAGE UNITS

Frontale Liscio Plain front

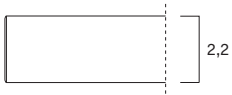
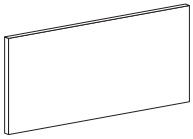

Maniglie: PUSH-PULL e in tutte le maniglie a catalogo.
Handles: PUSH-PULL and in all available handles from the catalogue.

Disponibilità: In tutte le misure dei contenitori.
Availability: In all storage units module sizes.

Materiali: Pannelli in agglomerato di legno sp. 2,2 cm con bordi arrotondati.
Materials: 2,2 cm-thick with rounded edging.

Riduzioni: I frontali lisci possono essere ridotti a misura.
Cutting to size: Plain fronts can be cut to size.

Frontale ERA ERA front

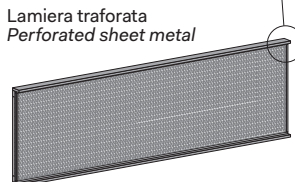
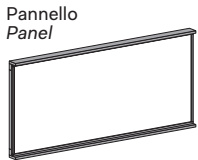
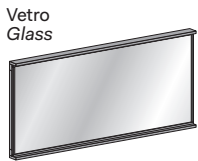

Finiture: Telaio con vetro sp. 0,4 cm, pannello sp. 1,2 cm o lamiera traforata sp. 15/10 mm
Finishes: Frame with 0,4 cm-thick glass, panel 1,2 cm thick or perforated sheet metal 1,5 mm thick

Maniglie: Incavo sul telaio.
Handles: Recess in frame.

Disponibilità: Anta ribalta/rialza / Pull-down/lift-up door L. / W. 59,8/89,8/119,8 - H. 31,6
Availability: Anta battente / Hinged door L. / W. 44,6/59,6
H. 63,8/95,8/127,8/159,8/191,8

Materiali: Profili telaio verticali sp. 0,8x3,5 cm in metallo.
Lamiera traforata sp. 15/10 con fori Ø 2 mm (solo ante H. 31,6 cm).
Vetri temprati sp. 0,4 cm. Pannelli in agglomerato di legno sp. 1,2 cm.
Materials: Metal vertical frame profiles 0,8 cm thick x 3,5 cm.
Perforated sheet metal 1,5 mm thick with 2 mm Ø holes (doors H 31,6 cm only).
0,4 cm thick toughened glass. 1,2 cm thick foil-wrapped.

Riduzioni: I frontali ERA non si possono ridurre a misura.
Cutting to size: ERA fronts cannot be cut to size.

NOVAMOBILI

BOX 18

FRONTALI PER CONTENITORI FRONTS FOR STORAGE UNITS

Frontale RAYS RAYS front

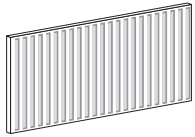

Maniglie: Handles:	PUSH-PULL o la GOLA (frontali H. 28,8). <i>PUSH-TO-OPEN mechanism or Profile opening system (fronts H 28,8).</i>
Disponibilità: Availability:	Anta ribalta/rialza / <i>Pull-down/lift-up door</i> L. / W. 44,8/59,8/89,8/119,8 H. 15,8/28,8 (GOLA)/31,8 Anta battente / <i>Hinged door</i> L. / W. 44,8/59,8 - H. 31,8/63,8 Cassetti / <i>Drawers</i> L. / W. 44,8/59,8/89,8/119,8 - H. 15,8 Cassettoni / <i>Oversized drawers</i> L. / W. 44,8/59,8/89,8/119,8 H. 28,8 (GOLA)/31,8
Materiali: Materials:	Legno pressato. <i>Pressed wood.</i>
Riduzioni: Cutting to size:	I frontali RAYS non si possono ridurre a misura. <i>RAYS fronts cannot be cut to size.</i>

Frontale DROPS DROPS front

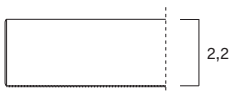
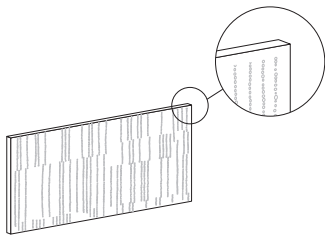

Maniglie: Handles:	PUSH-PULL o la GOLA (frontali H. 28,8). <i>PUSH-TO-OPEN mechanism or Profile opening system (fronts H 28,8).</i>
Disponibilità: Availability:	Anta ribalta/rialza / <i>Pull-down/lift-up door</i> L. / W. 44,8/59,8/89,8/119,8 H. 15,8/28,8 (GOLA)/31,8 Anta battente / <i>Hinged door</i> L. / W. 44,8/59,8 - H. 31,8/63,8 Cassetti / <i>Drawers</i> L. / W. 44,8/59,8/89,8/119,8 - H. 15,8 Cassettoni / <i>Oversized drawers</i> L. / W. 44,8/59,8/89,8/119,8 H. 28,8 (GOLA)/31,8
Materiali: Materials:	Pannelli in agglomerato di legno sp. 2,2 cm, con bordi arrotondati. Serigrafia a base di inchiostro verticale. <i>2,2 cm thick chipboard panels, with rounded edging. Vertical ink screen printing.</i>
Riduzioni: Cutting to size:	I frontali DROPS non si possono ridurre a misura. <i>DROPS fronts cannot be cut to size.</i>

NOVAMOBILI

BOX 18

TOP PER CONTENITORI TOPS FOR BASE STORAGE UNITS

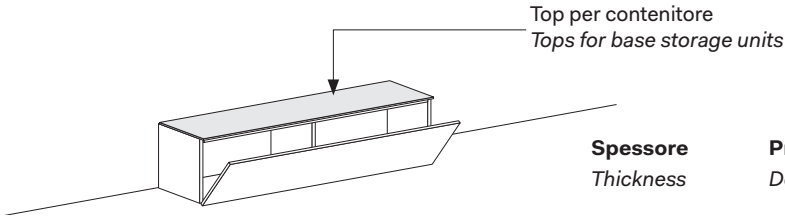

Sono possibili riduzioni a misura.
Reductions can be made.

Spessore Thickness	Profondità Depth	Larghezza Width
0,8 cm	28,7 cm	45 cm
1,2 cm	37,4 cm	60 cm
3 cm	45,5 cm	75 cm
5 cm	51,8 cm	90 cm
		105 cm
		120 cm
		135 cm
		150 cm
		165 cm
		180 cm
		195 cm
		210 cm
		225 cm
		240 cm
		255 cm
		270 cm
		271,6 cm
		Al mtl. max per sp. 0,8/3/5 cm Per linear m max. for 0,8/3/5 cm thick
		300 cm
		Al mtl. max per sp. 1,2 cm Per linear m max. for 1,2 cm thick

TOP IN MARMO PER CONTENITORI MARBLE TOPS FOR BASE STORAGE UNITS

È possibile forare il top in marmo per passacavi e vassoi.
It's possible to accommodate wiring and trays in marble tops.

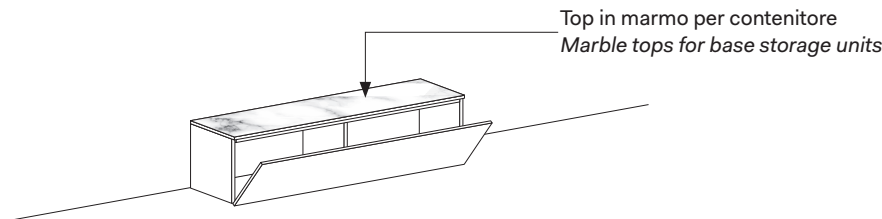

Non sono possibili riduzioni a misura.
No reductions can be made.

Spessore Thickness	Profondità Depth	Larghezza Width
2 cm	28,7 cm	45 cm
	37,4 cm	60 cm
	45,5 cm	75 cm
	51,8 cm	90 cm
		105 cm
		120 cm
		135 cm
		150 cm
		165 cm
		180 cm
		195 cm
		210 cm
		225 cm
		240 cm
		241,6 cm
		Al mtl. max Per linear m max.

NOVAMOBILI

BOX 18

TOP CON ALZATINA PER CONTENITORI TOPS WITH UPSTAND FOR BASE STORAGE UNITS

Altezza 5 cm (compreso di alzatina)
Height (including upstand)

Top con alzatina
Top with upstand

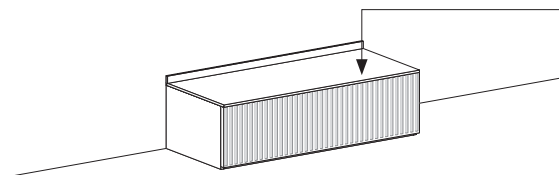

Vista laterale
Side view



Sono possibili riduzioni a misura.
Reductions can be made.

Spessore Thickness	Profondità Depth	Larghezza Width
1,2 cm	28,7 cm	45 cm
in folding	37,4 cm	60 cm
Mitre-folded	45,5 cm	75 cm
	51,8 cm	90 cm
		105 cm
		120 cm
		135 cm
		150 cm
		165 cm
		180 cm
		195 cm
		210 cm
		225 cm
		240 cm
		241,6 cm Al mtl. max Per linear m max.

TOP VASSOIO 4 LATI PER CONTENITORI 4-SIDED TRAY TOPS FOR BASE STORAGE UNITS

Altezza 5 cm
Height

Top vassoio 4 lati
4-sided tray top

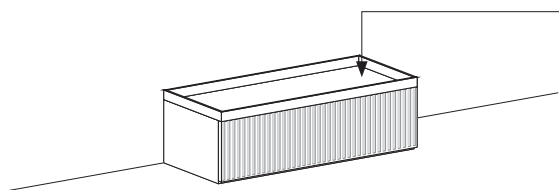

Sono possibili riduzioni a misura.
Reductions can be made.

Spessore Thickness	Profondità Depth	Larghezza Width
1,2 cm	28,7 cm	45 cm
in folding	37,4 cm	60 cm
Mitre-folded	45,5 cm	75 cm
	51,8 cm	90 cm
		105 cm
		120 cm
		135 cm
		150 cm
		165 cm
		180 cm
		181,6 cm Al mtl. max Per linear m max.

NOVAMOBILI

BOX 18

TOP VASSOIO 3 LATI PER CONTENITORI 3-SIDED TRAY TOPS FOR BASE STORAGE UNITS

Altezza 8,8 cm
Height

Contenitori H. 24/32/40/48 a
SX e a DX con top sp. 0,8 cm
24/32/40/48 cm-high storage
units on left and right with
0,8 cm-thick top

Top vassoio 3 lati
3-sided tray top

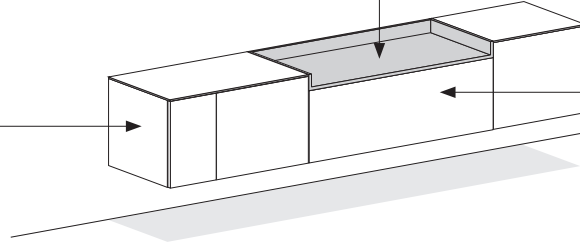

Contenitori H. 16/24/32/40 cm
16/24/32/40 cm-high storage units

Sono possibili riduzioni a misura.
Reductions can be made.

Spessore Thickness	Profondità Depth	Larghezza Width
0,8 cm	28,7 cm	45 cm
in folding	37,4 cm	60 cm
Mitre-folded	45,5 cm	75 cm
	51,8 cm	90 cm
		105 cm
		120 cm

TOP VASSOIO 3 LATI PER CONTENITORI 3-SIDED TRAY TOPS FOR BASE STORAGE UNITS

Altezza 16,8 cm
Height

Contenitori H. 32/40/48/64/80/96 cm
a SX e a DX con top sp. 0,8 cm
32/40/48/64/80/96 cm-high storage
units on left and right with
0,8 cm-thick top

Top vassoio 3 lati
3-sided tray top

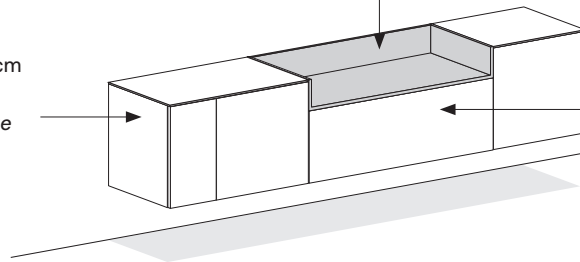

Contenitori H. 16/24/32/48/64/80 cm
16/24/32/48/64/80 cm-high storage
units

Sono possibili riduzioni a misura.
Reductions can be made.

Spessore Thickness	Profondità Depth	Larghezza Width
0,8 cm	28,7 cm	45 cm
in folding	37,4 cm	60 cm
Mitre-folded	45,5 cm	75 cm
	51,8 cm	90 cm
		105 cm
		120 cm

BOX 18

VASSOIO CREDENZA PER CONTENITORI SIDEBOARD TRAY FOR BASE STORAGE UNITS

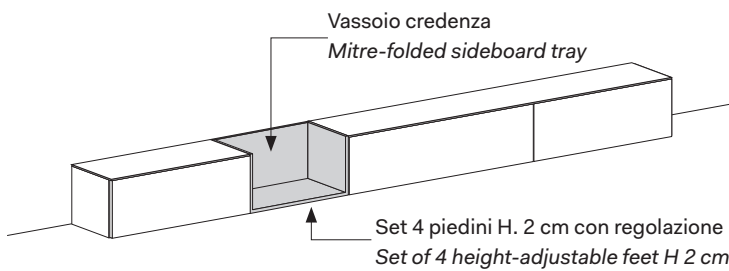
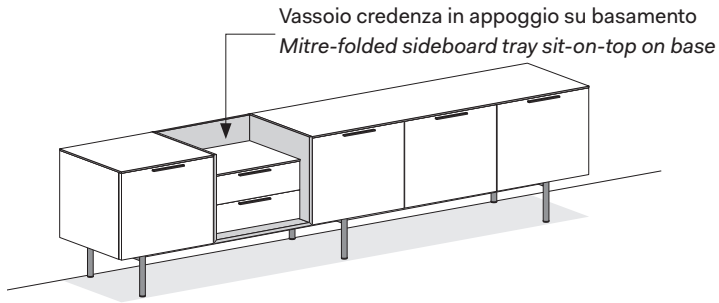

Spessore Thickness	Profondità Depth	Altezza Height	Larghezza Width
1,8 cm	45,5 cm	24,8 cm	48,9 cm
in folding	51,8 cm	32,8 cm	63,9 cm
Mitre-folded		40,8 cm	96,9 cm
		48,8 cm	

PIEDINI H. 2 CM FEET 2 CM HEIGHT

Finitura nero.
Black finish.



Set 4 piedini H. 2 cm con regolazione
Set of 4 height-adjustable feet H 2 cm

Sono possibili riduzioni a misura.
Reductions can be made.

VASSOIO TRAY-C AD INCASSO PER CONTENITORI RECESSED TRAY-C TRAY FOR BASE STORAGE UNITS

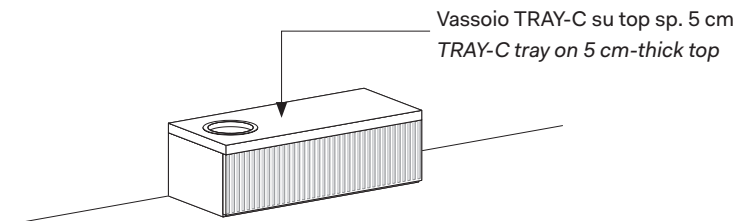

Posizionabili su tutti i top, escluso su top vassoio.
Can be placed on all tops, except tray tops.

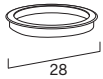

3 posizionamenti possibili
3 positioning options

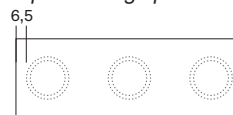

Vista in sezione del vassoio TRAY-C
Cross-section of TRAY-C tray

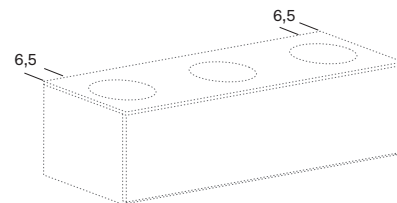
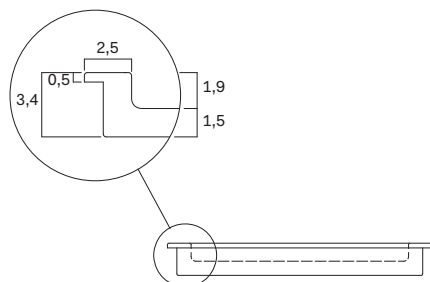

NOVAMOBILI

BOX 18

PASSACAVI PER TOP E VASSOI WIRING GROMMETS FOR TOPS AND TRAYS

PASSACAVI WIRING GROMMETS

In metallo brunito.
Metal in bronze finish.

Escluso top vassoio.
Except tray tops.

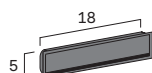

Chiuso
Closed

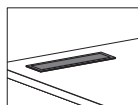

Aperto
Open

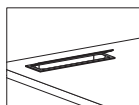

3 posizionamenti possibili
3 positioning options

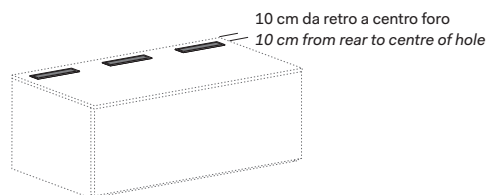

PASSACAVI WIRING GROMMETS

In plastica nero.
Black plastic.

Escluso top vassoio.
Except tray tops.

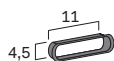

Aperto
Open

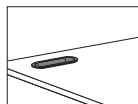

3 posizionamenti possibili
3 positioning options

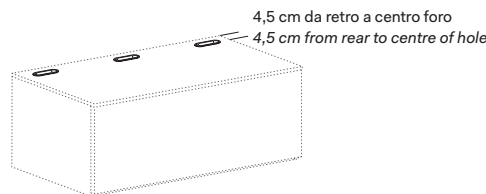

PASSACAVI CABLATO GROMMET + WIRING

In metallo alluminio.
Metal in Aluminium finish.

Solo sopra basi con ante a ribalta o battenti.
Only on top of base units with pull-down or hinged doors.
Solo con top sp. 0,8 / 1,2 cm.
With 0,8 / 1,2 cm-thick tops only.

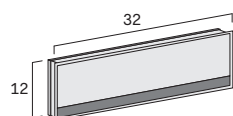

Chiuso
Closed

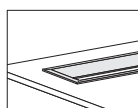

Aperto
Open

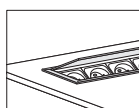

3 posizionamenti possibili
3 positioning options

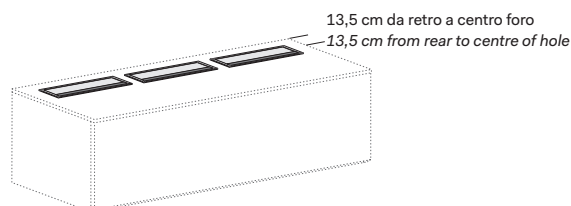

BOX 18

RICARICA WIRELESS SOTTOTOP UNDERMOUNTED WIRELESS CHARGING

La ricarica wireless consente di ricaricare il proprio telefono solo appoggiandolo sul piano, senza bisogno di cavi. La ricarica avviene quando il telefono è esattamente sopra il trasmettitore, per la localizzazione del punto esatto viene fornita una etichetta da applicare sul piano.

Wireless charging lets you charge your phone by simply placing it on the top, with no need for cables. Charging takes place when the phone is positioned directly on top of the transmitter: the kit comes with a sticker you can attach to the top to mark the exact point.



Verificare che il proprio dispositivo sia predisposto per tale tecnologia, consultando il sito del consorzio Qi wireless power.
(www.wirelesspowerconsortium.com)

*Make sure your device is Qi ready by checking the Qi wireless power consortium website.
(www.wirelesspowerconsortium.com)*

Contenuto: / Contents:



3 posizionamenti possibili
3 positioning options



NOVAMOBILI

BOX 18

BASAMENTI

BASES

Consentono di creare basi d'appoggio per contenitori.

They can be used to create bases to support BOX 18 storage units.

DOUBLE

Altezza 15 cm
Height

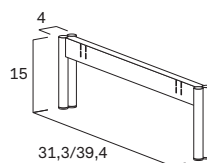
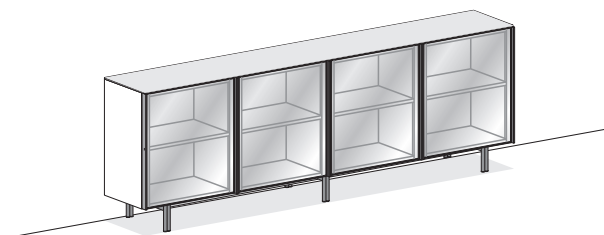

Per contenitori P. 37,4
For storage units D 37,4

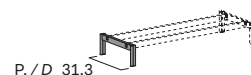

Per contenitori P. 45,5 o 51,8
For storage units D 45,5 or 51,8

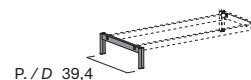

STRIPE

Altezza 15 cm
Height

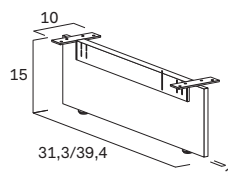
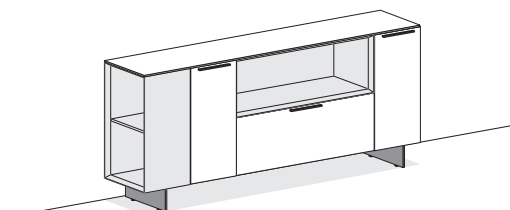

Per contenitori P. 37,4
For storage units D 37,4

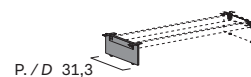

Per contenitori P. 45,5 o 51,8
For storage units D 45,5 or 51,8

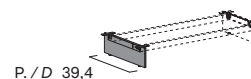

TUBE

Altezza 24 cm
Height

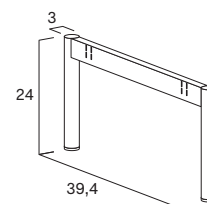
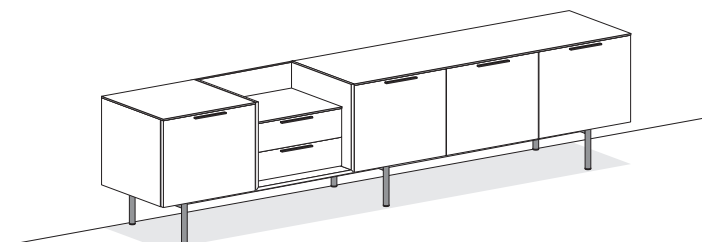

Per contenitori P. 45,5 o 51,8
For storage units D 45,5 or 51,8

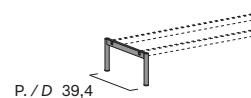

NOVAMOBILI

BOX 18

COPIA TRAVERSE PER DOUBLE, STRIPE E TUBE

PAIR OF CROSSPIECES FOR DOUBLE, STRIPE AND TUBE

Altezza 4 cm

Height

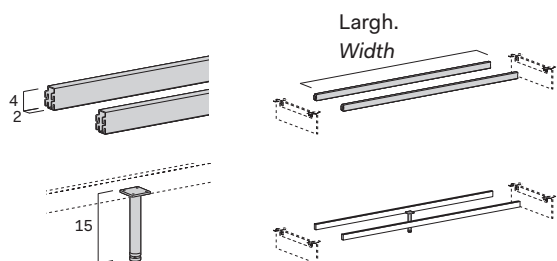

Spessore
Thickness

2 cm

Larghezza
Width

55,2 cm

101,2 cm

129,2 cm

151,2 cm Complete di piedino centrale Ø 2,5
Complete with central 2,5 cm Ø foot.

168 cm Complete di piedino centrale Ø 2,5
Complete with central 2,5 cm Ø foot.

201,2 cm Complete di piedino centrale Ø 2,5
Complete with central 2,5 cm Ø foot.

ILLUMINAZIONE PER BASAMENTI

BASE LIGHTING

Da completare con trasformatori (vedi pag. 20).

To be finished off with transformers (see pag. 20).

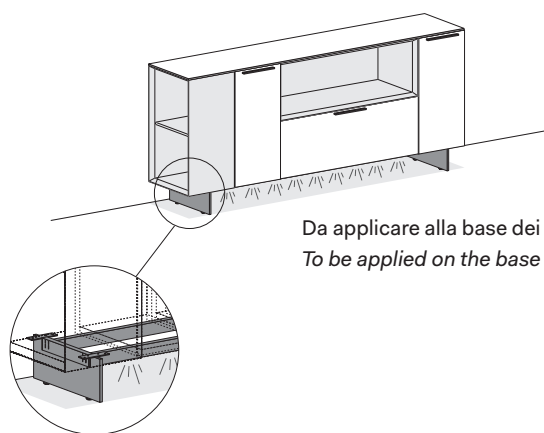

Da applicare alla base dei contenitori.

To be applied on the base of the storage units.

Strip LED

LED strip

Larghezza

Width

50 cm (traverse / crosspieces 55,2)

100 cm (traverse / crosspieces 101,2)

125 cm (traverse / crosspieces 129,2)

150 cm (traverse / crosspieces 151,2)

165 cm (traverse / crosspieces 168)

200 cm (traverse / crosspieces 201,2)

NOVAMOBILI

BOX 18

PIANI SP. 5 CM PER CONTENITORI 5 CM-THICK TOPS FOR STORAGE UNITS

ESEMPI EXAMPLES

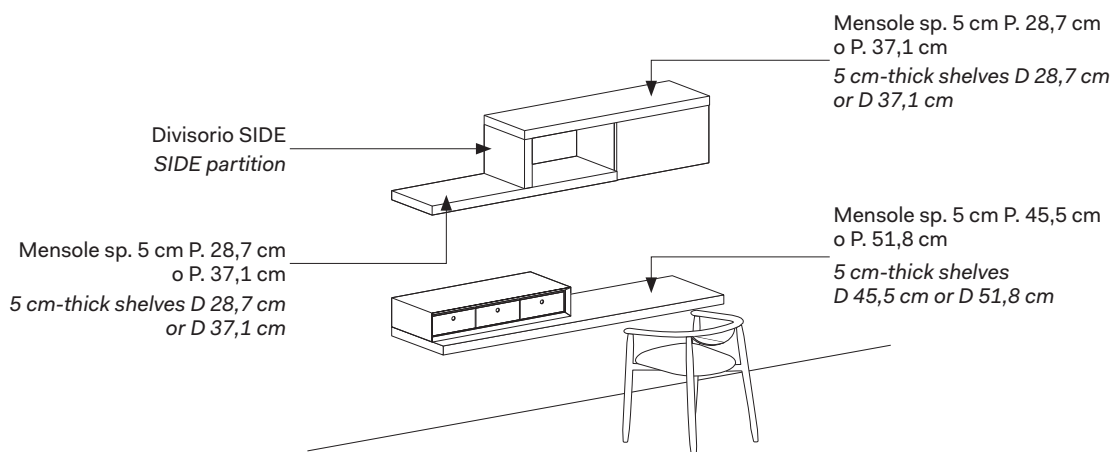
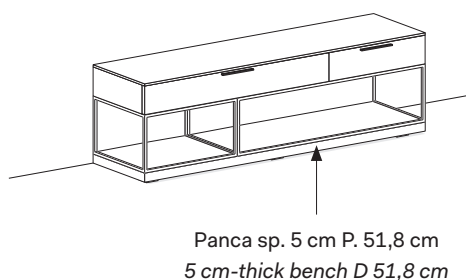
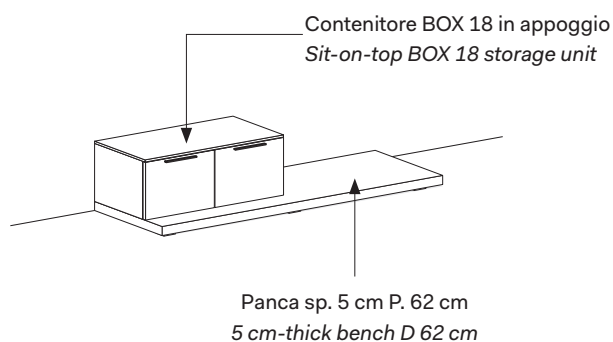
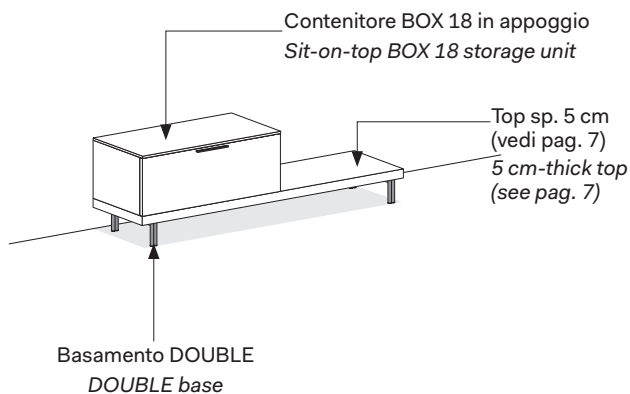
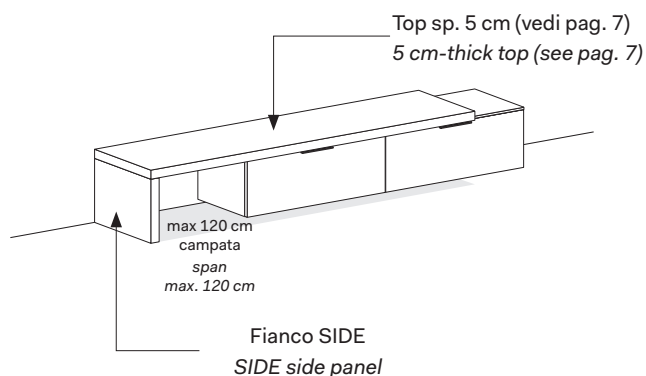

BOX 18

PANCA SP. 5 CM

5 CM-THICK BENCH

Con piedini H. 2 cm regolabili (H. totale 7 cm).

With height-adjustable feet H 2 cm (Total H 7 cm).

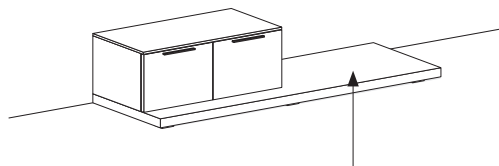

Panca sp. 5 cm
Bench th. 5 cm

Sono possibili riduzioni a misura.

Reductions can be made.

Spessore
Thickness

5 cm

Profondità
Depth

51,8 cm
62 cm

Larghezza
Width

90 cm
120 cm
135 cm
150 cm
180 cm
210 cm *
240 cm *
270 cm *

* valido per P 51,8 cm

available only for d 51,8 cm

MENSOLA SP. 5 CM PER CONTENITORI

5 CM-THICK WALL SHELF FOR STORAGE UNITS

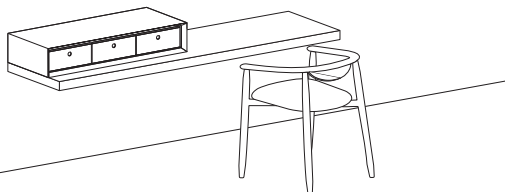
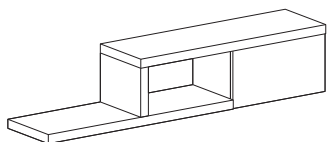

Spessore
Thickness

5 cm

Profondità
Depth

28,7 cm
37,4 cm
45,5 cm
51,8 cm

Larghezza
Width

60 cm
90 cm
120 cm
135 cm
150 cm
180 cm
210 cm
240 cm
270 cm

Sono possibili riduzioni a misura.

Reductions can be made.

FIANCO E DIVISORIO SIDE SP. 5 CM

SIDE SIDE PANEL AND PARTITION 5 CM-THICK

Altezza Da H. 18,1 cm a H. 55,1 cm

Height From H 18,1 cm to H 55,1 cm

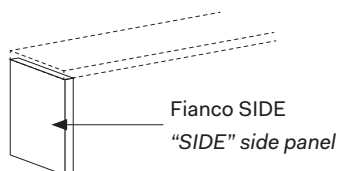

Fianco SIDE
"SIDE" side panel

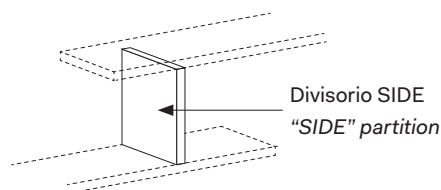

Divisorio SIDE
"SIDE" partition

Spessore
Thickness

5 cm

Profondità
Depth

28,6 cm
37,3 cm
45,4 cm
51,7 cm

Per inserimento tra 2 mensole sp. 5 cm o 2 piani a muro sp. 5 cm.

To be inserted between two 5 cm-thick shelves or two 5 cm-thick wall-mounted tops.

BOX 18

CONTENITORE CON PORTA TV GIREVOLE

BASE STORAGE UNIT WITH TV SWIVEL MOUNT

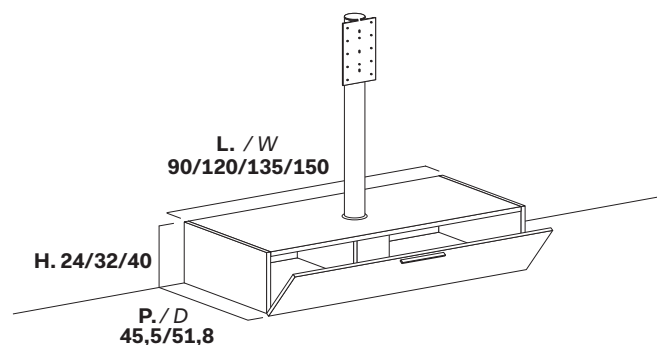

Le basi vanno completate con i seguenti accessori:

- pannello porta TV nella versione con passacavi per il posizionamento centrato
- pannello porta TV nella versione senza passacavi che consente un posizionamento decentrato per un maggiore angolo di visibilità
- kit staffe VESA per fissare direttamente la TV al supporto orientabile

They must be finished off with the following accessories:

- *TV mounting panel in version with wiring grommet for centred positioning*
- *TV mounting panel in version without wiring grommet that allows for offset positioning for an increased viewing angle*
- *VESA bracket kit for fastening the TV directly to the swivel mount*

BASE PORTA TV CON PANNELLO CON PASSACAVI

TV STAND WITH PANEL WITH WIRING GROMMET

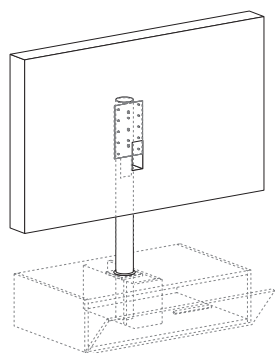

BASE PORTA TV CON STAFFE "VESA"

TV STAND WITH "VESA" BRACKETS

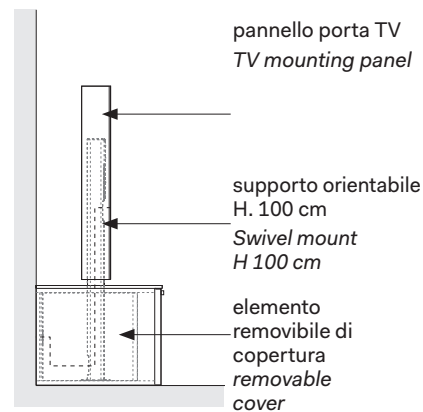
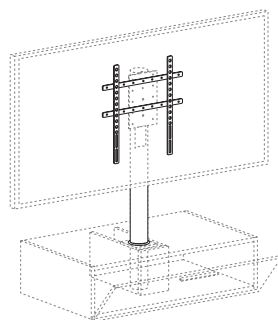

BASE PORTA TV CON PANNELLO SENZA PASSACAVI

TV STAND WITH PANEL WITHOUT WIRING GROMMET

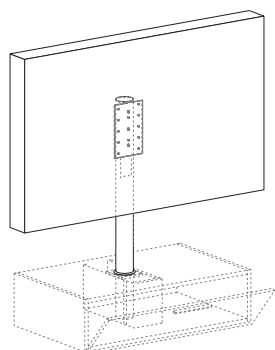

BOX 18

ILLUMINAZIONE INTERNA PER CONTENITORI INTERNAL LIGHTING FOR STORAGE UNITS

Luce LED sp. 0,6 cm fornita applicata ad incasso alla scocca dei contenitori.
LED lighting, 0,6 cm thick, comes with the lighting strip recessed into the storage unit carcass.

Luce LED orizzontale 24V 3000K

Horizontal 24V 3000K LED light

Disponibile su tutti i contenitori dalla larghezza 30 a 150 cm.
Available in all storage units from w 30 cm to 150 cm.

Da completare con trasformatori (vedi pag. 20).
To be finished off with transformers (see pag. 20).

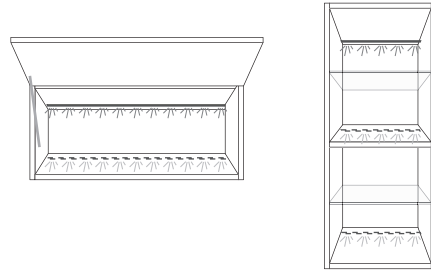

Luce LED verticale 24V 3000K

Vertical 24V 3000K LED light

Disponibile su tutti i contenitori dall'altezza 64 a 192 cm.
Available in all storage units from w 30 cm to 150 cm.

Da completare con trasformatori (vedi pag. 20).
To be finished off with transformers (see pag. 20).

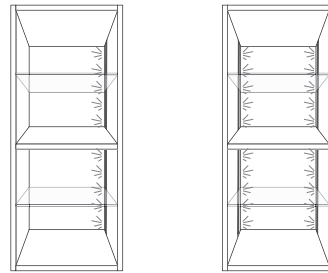

ILLUMINAZIONE INTERNA CASSETTONI INTERNAL LIGHTING FOR OVERSIZED DRAWERS

Viene realizzata tramite un profilo LED applicato alla parte frontale dei fianchi e dotato di sensore autonomo di accensione.
Produced by means of a LED strip attached to the front of the panels at each side and fitted with an automatic switch-on sensor.

Luce LED orizzontale 24V 3000K con sensore

Horizontal 24V 3000K LED light with sensor

Disponibile su tutti i cassettoni dalla larghezza 44,8 a 119,8 cm.
Available in all oversized drawer base unit from w 44,8 cm to 119,8 cm.

Da completare con trasformatori (vedi pag. 20).
To be finished off with transformers (see pag. 20).

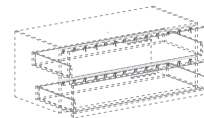

BOX 18

FARETTO LED RICARICABILE USB USB RECHARGEABLE LED SPOTLIGHT

Con sensore di presenza.
With presence detector.

Applicabile su cappelli o ripiani in quanto privo di cavi.
You can put it on tops or shelves as it has no cables.

Privo di cavi.
No cables.

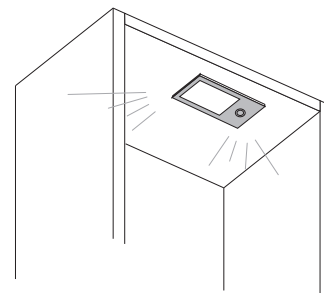
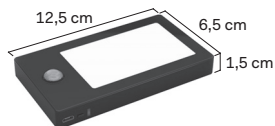

PANNELLI ATTREZZATI PER RETROILLUMINAZIONE PERIMETRALE FUNCTIONAL PANELS FOR PERIMETER BACKLIGHTING

Pannello sp. 1,8 cm al mq. con due fresate verticali e/o orizzontali per l'inserimento della luce LED.
Panel 1,8 cm thick per sq m with two vertical and/or horizontal grooves for inserting LED lighting.

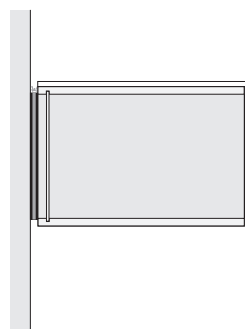
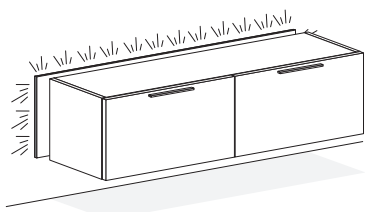

PANNELLO ORIZZONTALE HORIZONTAL PANEL

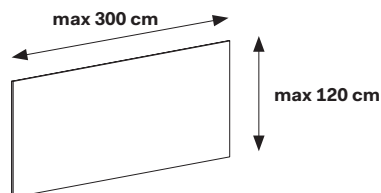

PANNELLO VERTICALE VERTICAL PANEL

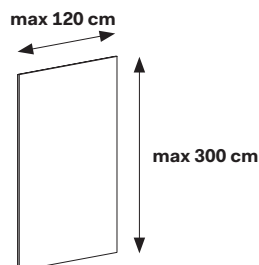

NOVAMOBILI

BOX 18

TRASFORMATORE SMART SMART TRANSFORMER

Il trasformatore SMART può essere integrato con i moduli per il controllo remoto da applicazioni con tecnologia Bluetooth o Wi-Fi. Tramite le applicazioni dei moduli Bluetooth o Wi-Fi è possibile regolare l'intensità delle luci collegate al singolo trasformatore o a più trasformatori. Cavo 2 metri.

The SMART transformer can be integrated with modules for remote control via apps with Bluetooth or Wi-Fi technology. Via Bluetooth or Wi-Fi module apps, you can control the lighting level of lights connected to a single transformer or to a number of transformers. 2-metre cable.

Trasformatore SMART 15 W
15W SMART transformer

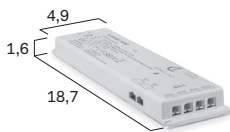

Sp. 1,6 L. 18,7 P. 4,9
Th 1,6 W 18,7 D 4,9
(max 4 luci LED)
(max. 4 LED lights)

Trasformatore SMART 30 W
30W SMART transformer

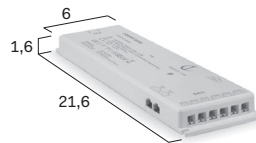

Sp. 1,6 L. 21,6 P. 6
Th 1,6 W 21,6 D 6
(max 6 luci LED)
(max. 6 LED lights)

Trasformatore SMART 60 W
60W SMART transformer

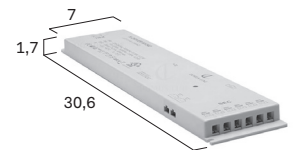

Sp. 1,7 L. 30,6 P. 7
Th 1,7 W 30,6 D 7
(max 6 luci LED)
(max. 6 LED lights)

I moduli opzionali Bluetooth e Wi-Fi vengono forniti con allegate istruzioni per il download delle relative applicazioni.

The optional Bluetooth and Wi-Fi modules come with instructions for downloading the relevant apps.



SENSORE I.R. IR SENSOR

Opzionalmente è possibile comandare l'accensione/spegnimento delle luci all'apertura/chiusura del frontale battente, per mezzo di un sensore I.R. As an optional extra, an IR sensor can be used to switch lights on/off when the hinged front is opened/closed.



POSIZIONAMENTO DEL SENSORE SENSOR POSITIONING

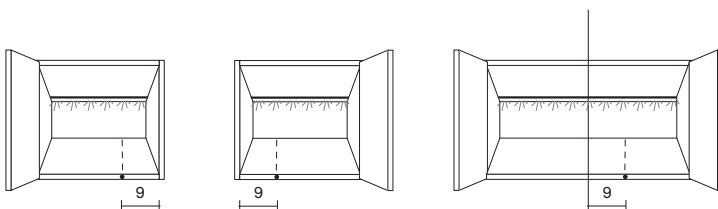

NOVAMOBILI

BOX 18

RIDUZIONI A MISURA

CUTTING TO SIZE

RIDUZIONE IN LARGHEZZA

WIDTH REDUCTION

Base o Cappello contenitore / *Storage unit base or Top cover*

Ripiano / *Shelf*

Anta / *Door*

Schiena contenitore sp. 0,6 cm / *Storage unit back panel 0,6 cm thick*

Panca / *Bench*

ELEMENTI NON RIDUCIBILI

ITEMS THAT CANNOT BE CUT TO SIZE

- Frontali RAY/DROPS/ *RAY/DROPS fronts*
- Cassetti, cassettoni, portacartelle / *Drawers, oversized drawers, hanging folder system*
- Ante vetro / *Glass doors*
- Ripiani in vetro / *Glass shelves*

LIMITAZIONI

LIMITATIONS

- I contenitori pensili BOX 18 sono riducibili, ma non nella variante con ripiani in vetro.
- *Reductions are possible on BOX 18 wall units, but not if they feature glass shelves.*

RIDUZIONE IN PROFONDITÀ

DEPTH REDUCTION

Base o Cappello contenitore / *Storage unit base or Top cover*

Ripiano / *Shelf*

Fianco / *Side panel*

ELEMENTI NON RIDUCIBILI

ITEMS THAT CANNOT BE CUT TO SIZE

- Cassetti, cassettoni, portacartelle / *Drawers, oversized drawers, hanging folder system*
- Contenitori base con divisorio centrale / *Base storage units with central partition*

LIMITAZIONI

LIMITATIONS

- I contenitori pensile sono riducibili, ma non nella variante con ripiani in vetro.
- I contenitori BOX 18 si possono ridurre fino ad un minimo di 18,3 cm.
- I contenitori BOX 18 con ribalta FILO P. 28,3 cm non sono riducibili in profondità.
- *Reductions are possible on wall units, but not if they feature glass shelves*
- *The minimum reduction on BOX 18 units is 18,3 cm.*
- *No reductions in depth are possible for BOX 18 units with FILO pull-down doors D 28,3.*

RIDUZIONE IN ALTEZZA

HEIGHT REDUCTION

Anta / *Door*

Fianco / *Side panel*

Schiena contenitore sp. 0,6 cm / *Storage unit back panel 0,6 cm thick*

ELEMENTI NON RIDUCIBILI

ITEMS THAT CANNOT BE CUT TO SIZE

- Frontali RAYS/DROPS / *RAYS/DROPS fronts*
- Cassetti, cassettoni, portacartelle / *Drawers, oversized drawers, hanging folder system*
- Ribalta / Rialza / *Pull-down / Lift-up*
- Ante vetro / *Glass doors*

NOVAMOBILI

BOX 18

NOTE PER IL MONTAGGIO

ASSEMBLY NOTES

I contenitori vengono forniti già montati e dotati di viti di unione.
Storage units come ready assembled and complete with screws for connecting them.

PERSONALIZZAZIONE

CUSTOMIZING

É possibile la realizzazione di combinazioni non codificate di scocche e frontali.
Carcasses and fronts can be mixed and matched even in combinations without a preset item code.

NOTE PER LA SICUREZZA

NOTES ON SAFETY

I contenitori sospesi devono essere fissati con cura alla parete in muratura e non devono essere oggetto di carichi eccessivi.
Assicurarsi preventivamente che la parete sia idonea a sostenere il peso degli elementi pensili nelle condizioni di utilizzo del cliente.

Wall-mounted units must be fastened carefully to a masonry wall and must not be subjected to excessive loads. Make sure beforehand that the wall is strong enough to take the weight of wall units under the customer's normal conditions of use.

PORTATA MASSIMA CONTENITORI A MURO

LOAD CAPACITY OF WALL-MOUNTED UNITS

H. L/W	16/24	32/40	48	64	80/96	128/160 / 192
30	--	kg 20	kg 20	kg 25	kg 30	kg 30
45	kg 15	kg 20	kg 20	kg 25	kg 30	kg 30
60	kg 15	kg 20	kg 20	kg 25	kg 30	kg 30
75	kg 15	kg 20	kg 20	kg 25	kg 30	--
90	kg 15	kg 20	kg 20	kg 25	kg 30	--
120	kg 15	kg 20	kg 20	kg 25	kg 30	--
135	kg 20	kg 25	--	--	--	--
150	kg 20	kg 30	--	--	--	--