

FLEXFORM

MADE IN ITALY



HARPER ANTONIO CITTERIO 2021

DIVANI | DIVANI COMPONENTI | POUF SOFAS | SECTIONAL SOFAS | OTTOMANS

FLEXFORM Spa

Via Einaudi 23/25 20821 Meda (MB) Italy | Tel. +39 0362 3991 | Fax +39 0362 399228 | info@flexform.it | www.flexform.it

HARPER | ANTONIO CITTERIO | 2021

Struttura

in legno con imbottitura in poliuretano espanso rivestito in tessuto protettivo accoppiato

Schienale / Bracciolo

in metallo con imbottitura in poliuretano stampato e dacron, rivestiti in tessuto protettivo accoppiato

Bracciolo portariviste

in metallo rivestito in cuoio nei colori: bianco (5007), grigio (5003), testa di moro (5004), testa di moro scuro (5013), nero (5005), oliva (5006), rosso bulgaro (5008), sabbia (5001), tabacco (5015), scamosciato moro (6004), scamosciato nero (6005), scamosciato oliva (6003), scamosciato sabbia (6001).
Piedi in metacrilato trasparente lucido

Supporto schienale/bracciolo

in metallo rivestito in cuoio nei colori: bianco (5007), grigio (5003), testa di moro (5004), testa di moro scuro (5013), nero (5005), oliva (5006), rosso bulgaro (5008), sabbia (5001), tabacco (5015), scamosciato moro (6004), scamosciato nero (6005), scamosciato oliva (6003), scamosciato sabbia (6001); oppure nelle finiture cromato, satinato, brunito, cromo nero, canna di fucile. Di serie sul bracciolo imbottito; optional sullo schienale di ogni elemento, a richiesta con supplemento di prezzo

Cuscini seduta

in fibra di poliestere con inserto in materiale indeformabile a densità unica. Seduta premium in piuma d'oca sterilizzata (certificata Assopiuma, Etichetta Oro) con inserto in materiale indeformabile ad alta resilienza

Cuscini schienale

in piuma d'oca sterilizzata (certificata Assopiuma, Etichetta Oro)

Cuscini optional

in piuma d'oca sterilizzata (certificata Assopiuma, Etichetta Oro), a richiesta con supplemento di prezzo

Base

in metallo verniciato a forno con polveri epossidiche di colore nero. Appoggio a terra su puntali in materiale termoplastico

Rivestimento

sfoderabile sia nella versione in tessuto che nella versione in pelle

Profilo rivestimento

la confezione prevede un profilo in gros grain che può essere realizzato in tutti i colori della cartella campioni

Structure

in wood with polyurethane foam padding covered with a protective laminated fabric

Backrest / Armrest

in metal with molded polyurethane and Dacron padding, covered with a protective laminated fabric

Magazine caddy armrest

in metal clad in cowhide in the following colors: white (5007), grey (5003), dark brown (5004), extra dark brown (5013), black (5005), olive (5006), Bulgarian red (5008), sand (5001), tobacco (5015), dark brown suede (6004), black suede (6005), olive suede (6003), sand suede (6001).

Feet made of glossy transparent methacrylate

Backrest/armrest support

in metal clad in cowhide in the following colors: white (5007), grey (5003), dark brown (5004), extra dark brown (5013), black (5005), olive (5006), Bulgarian red (5008), sand (5001), tobacco (5015), dark brown suede (6004), black suede (6005), olive suede (6003), sand suede (6001); or with the following finishes: chrome, satin, burnished, black chrome, gunmetal. Standard on upholstered armrests; optional on all backrests, upon request with upcharge

Seat cushions

in polyester fiber with insert in single-density crushproof material. Premium seat cushions in sterilized goose down (Assopiuma Certified, Gold Label) with insert in high resilience crushproof material

Backrest cushions

in sterilized goose down (Assopiuma Certified, Gold Label)

Optional cushions

in sterilized goose down (Assopiuma Certified, Gold Label); upon request, with upcharge

Base

in black epoxy powder-coated metal. Rests on tips made of thermoplastic material

Upholstery

is removable in both the fabric and leather versions

Upholstery piping

fine tailoring includes grosgrain piping that can be crafted in all the colors on the sample board

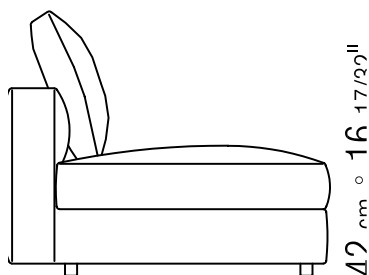











28802

28803

28804

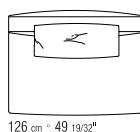
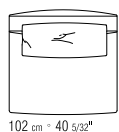
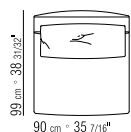
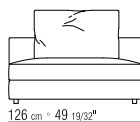
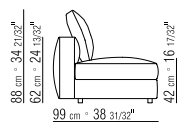

28805

28806

28807

28808

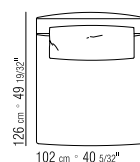
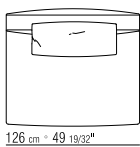
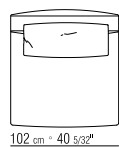
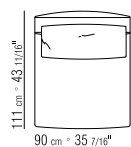
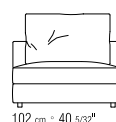
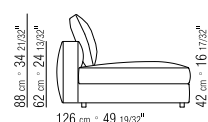
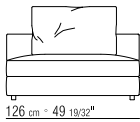
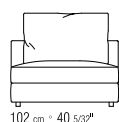
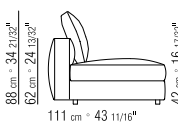

28823

28827

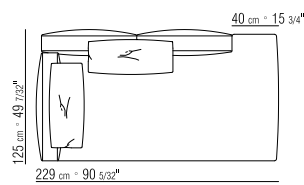
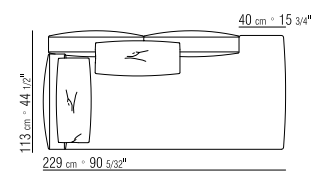
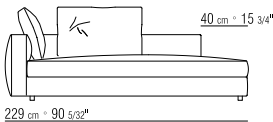
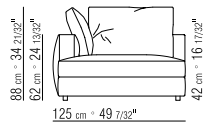
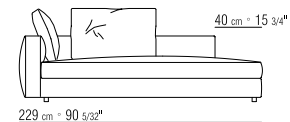
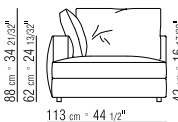

28831

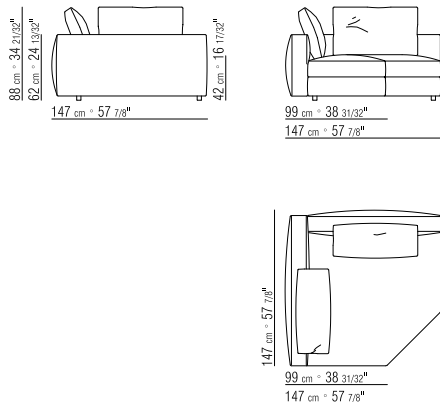

28837

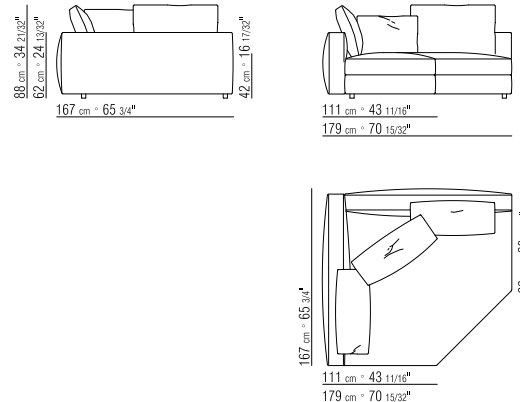

28838

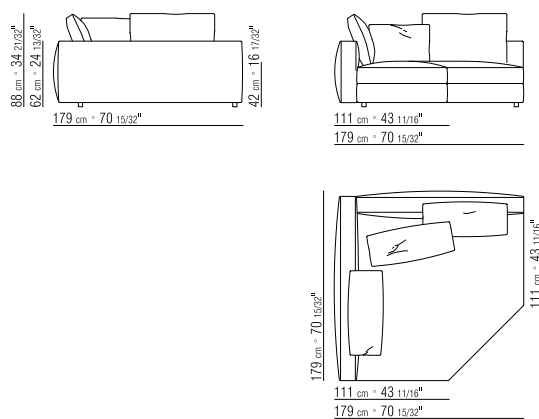

28841

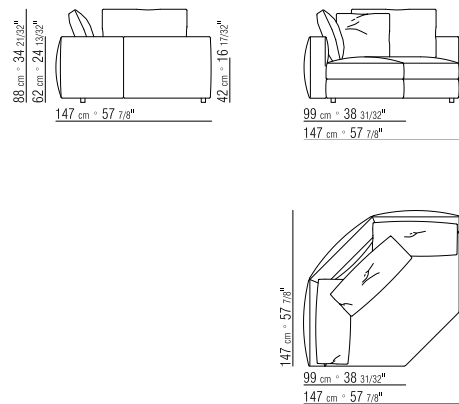

28847

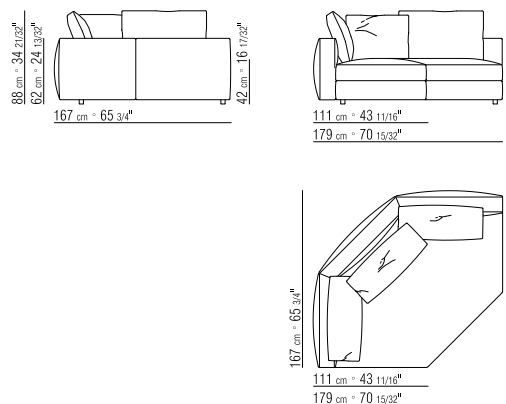

28848

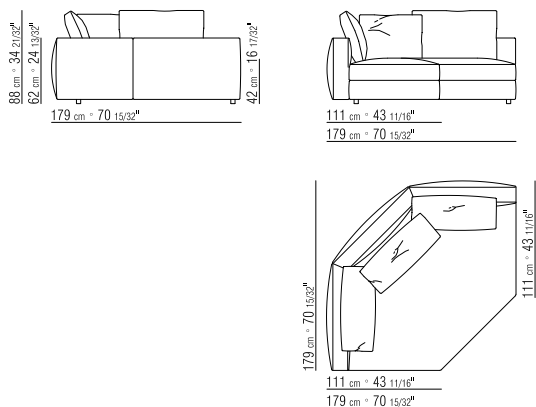

28850

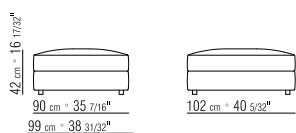

28851

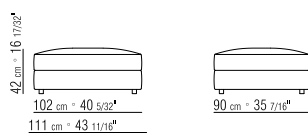

28852

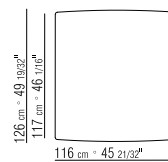
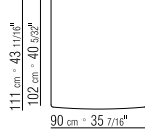
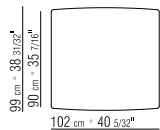
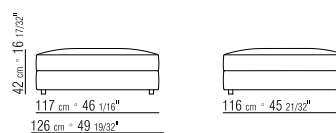

28870

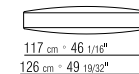
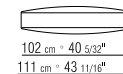
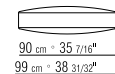
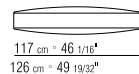
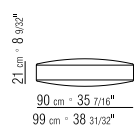
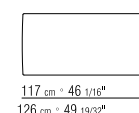
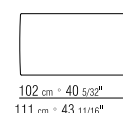
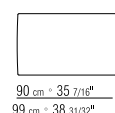
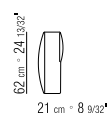
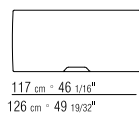
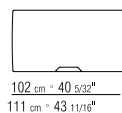
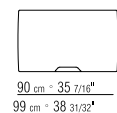
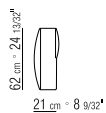

28876

28877

28878

28879

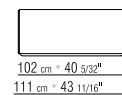
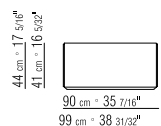
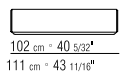
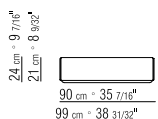
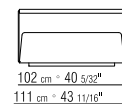
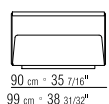
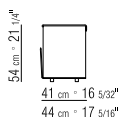
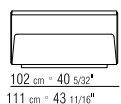
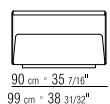
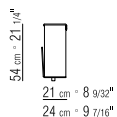

28895

28898

28899



288XA

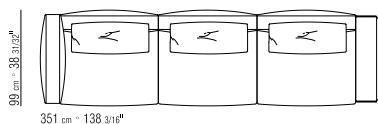

- | | | |
|---|--|---|
| N.1 COD. 28870 bracciolo cm.90 | | N.1 COD. 28870 armrest cm.90 |
| N.3 COD. 28803 elemento cm.102x99 | | N.3 COD. 28803 unit cm.102x99 |
| N.1 COD. 28876 bracciolo cuoio cm.90 | | N.1 COD. 28876 armrest w/hideleather cm.90 |
| N.3 COD. 28895 supporto schienale | | N.3 COD. 28895 backrest support |
| cuscini optional suggeriti (prezzo non incluso) | | suggested option cushion (price not included) |
| N.3 COD. 28898 cuscino cm.50x45 | | N.3 COD. 28898 cushion cm.50x45 |

288XB

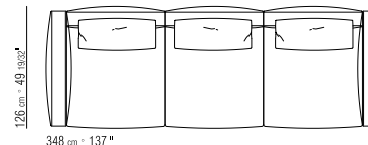

- | | | |
|---|--|---|
| N.2 COD. 28874 bracciolo cm.117 | | N.2 COD. 28874 armrest cm.117 |
| N.3 COD. 28808 elemento cm.102x126 | | N.3 COD. 28808 unit cm.102x126 |
| N.3 COD. 28895 supporto schienale | | N.3 COD. 28895 backrest support |
| cuscini optional suggeriti (prezzo non incluso) | | suggested option cushion (price not included) |
| N.5 COD. 28898 cuscino cm.50x45 | | N.5 COD. 28898 cushion cm.50x45 |

288XC

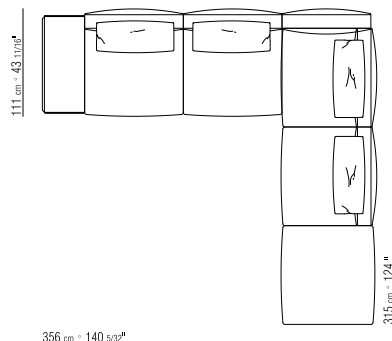

- | | | |
|---|--|---|
| N.1 COD. 28879 bracciolo cuoio cm.102 | | N.1 COD. 28879 armrest w/hideleather cm.102 |
| N.2 COD. 28806 elemento cm.102x111 | | N.2 COD. 28806 unit cm.102x111 |
| N.1 COD. 28871 schienale angolo cm.90 | | N.1 COD. 28871 corner armrest cm.90 |
| N.2 COD. 28803 elemento cm.102x99 | | N.2 COD. 28803 unit cm.102x99 |
| N.1 COD. 28850 pouf cm.102x90 | | N.1 COD. 28850 ottoman cm.102x90 |
| N.5 COD. 28895 supporto schienale | | N.5 COD. 28895 backrest support |
| cuscini optional suggeriti (prezzo non incluso) | | suggested option cushion (price not included) |
| N.5 COD. 28898 cuscino cm.50x45 | | N.5 COD. 28898 cushion cm.50x45 |

288XD

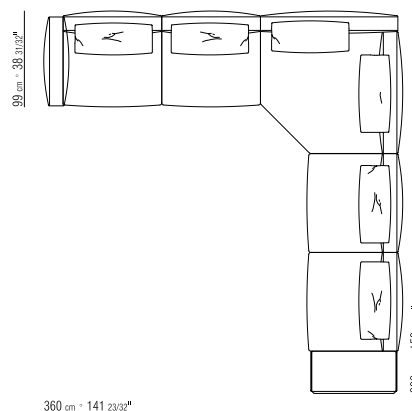

- | | | |
|---|--|--|
| N.1 COD. 28870 bracciolo cm.90 | | N.1 COD. 28870 armrest cm.90 |
| N.4 COD. 28803 elemento cm.102x99 | | N.4 COD. 28803 unit cm.102x99 |
| N.1 COD. 28831 elem. angolare 5 lati cm.147x147 | | N.1 COD. 28831 five sided corner unit cm.147x147 |
| N.1 COD. 28878 tavolino cuoio cm.90 | | N.1 COD. 28878 small table w/hideleather cm.90 |
| N.6 COD. 28895 supporto schienale | | N.6 COD. 28895 backrest support |
| cuscini optional suggeriti (prezzo non incluso) | | suggested option cushion (price not included) |
| N.4 COD. 28898 cuscino cm.50x45 | | N.4 COD. 28898 cushion cm.50x45 |
| N.1 COD. 28899 cuscino cm.80x60 | | N.1 COD. 28899 cushion cm.80x60 |

288XE

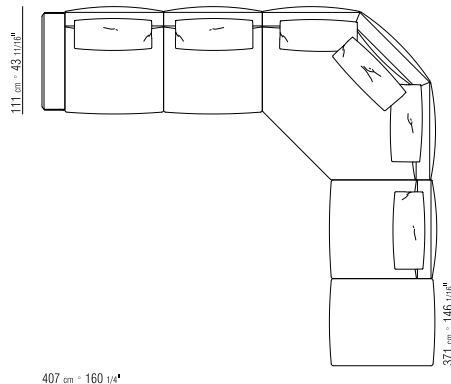

- | | | |
|--|--|---|
| N.1 COD. 28877 bracciolo cm.102 | | N.1 COD. 28877 armrest cm.102 |
| N.3 COD. 28806 elemento cm.102x111 | | N.3 COD. 28806 unit cm.102x111 |
| N.1 COD. 28848 elemento angolare 6 lati cm.179x179 | | N.1 COD. 28848 six sided corner unit cm.179x179 |
| N.1 COD. 28851 pouf cm.90x102 | | N.1 COD. 28851 ottoman cm.90x102 |
| N.6 COD. 28895 supporto schienale | | N.6 COD. 28895 backrest support |
| cuscini optional suggeriti (prezzo non incluso) | | suggested option cushion (price not included) |
| N.6 COD. 28898 cuscino cm.50x45 | | N.6 COD. 28898 cushion cm.50x45 |