

Trust Desk – Lievore - Altherr - Park — 2018

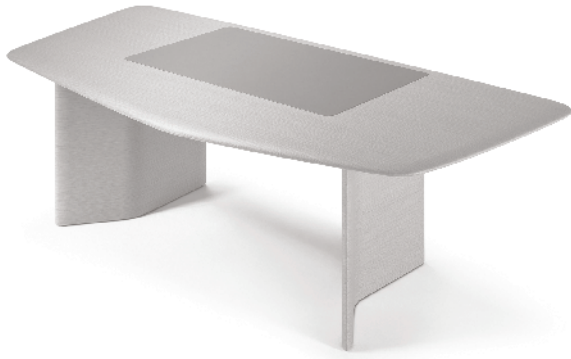

TRUST è un sistema di design e al tempo stesso un sistema di valori. La collezione comprende scrivanie, pareti autoportanti e contenitori per l'archiviazione. Superfici, contorni, architetture concorrono a creare una scenografia di serenità e fiducia. A configurare uno spazio duttile e aperto, dove il dialogo prende forma. Tutti gli elementi TRUST sono liberamente combinabili fra loro per organizzare gli interni, adattandosi allo stile di lavoro di chi li abita. Volumi e costruzioni sono aerei, leggeri e insieme materici.

CARATTERISTICHE TECNICHE

Modelli.

- Regular desk
 - 183×92 cm
 - 214×107 cm
 - 214×107 cm with storage unit
- Iconic desk
 - 183×97 cm
 - 214×107 cm
 - 228×137 cm
 - 214×107 cm with storage unit
- Small desk
 - 145×68 cm
 - 145×68 cm with storage unit

REGULAR DESK / ICON DESK

Piano.

- Rovere naturale TW (70)
- Rovere medio TW (71)
- Pelle Frau® ColorSphere® (SC)
- Saddle Executive

Piano in rovere TW. Realizzato in fibra di legno a media densità con impiallacciatura in rovere TW. Il piano è completato da un sottomano in fibra di legno a media densità a semifilo con il top e rivestito in pelle o cuoio.

Sottomano:

- Pelle Frau® SC
- Saddle Executive

TW (acronimo di Techno-wood). Indica il processo tecnologico necessario a trasformare una selezione di legni naturali in un tranciato che replica la venatura tipica del rovere. L'utilizzo di questo materiale garantisce uniformità della venatura e del colore.

Piano in pelle o cuoio. Realizzato con un'anima in multistrato di betulla racchiusa tra due strati di fibra di legno a media densità e rivestiti in pelle o cuoio nella parte superiore e lungo i bordi. La superficie inferiore dei piani è verniciata nera. Può essere provvisto di sportello passacavi.

Sportello passacavi.

- con sportello passacavi
- senza sportello passacavi

Sportello passacavi (nei modello che lo prevedono). Sportello a ribalta

TRUST is a design system collection and at the same time a system of values. The collection consists of desks, self-supporting screens and cabinets. Surfaces, outlines, architectures contribute to create a scene of calm and confident atmosphere and to configure a flexible and open space, where dialogue takes shape. All the elements of the TRUST collection can be freely combined to organise the interiors, adapting to the work habits of their users. Volumes and structures are airy, light and at the same time tangible.

TECHNICAL FEATURES

Items.

- Regular desk
 - 183×92 cm
 - 214×107 cm
 - 214×107 cm with storage unit
- Iconic desk
 - 183×97 cm
 - 214×107 cm
 - 228×137 cm
 - 214×107 cm with storage unit
- Small desk
 - 145×68 cm
 - 145×68 cm with storage unit

REGULAR DESK / ICON DESK

Top.

- Natural oak TW (70)
- Medium oak TW (71)
- Pelle Frau® ColorSphere® (SC)
- Saddle Executive

Top in oak TW. Made of medium-density wood fibre veneered in oak TW. The top is completed by a semi- flat-edge working pad in medium-density wood fibre upholstered in leather or saddle-leather.

Working pad:

- Pelle Frau® SC
- Saddle Executive

TW (acronym for Techno-wood). Indicates the technological process required to transform a selection of natural woods into a veneer that replicates the typical grain of oak. The use of this material ensures uniform grain and colour.

Top in leather or saddle-leather. Made with a birch plywood core enclosed between two layers of medium-density wood fibre, with the upper part and edges upholstered in leather or saddle-leather. The lower surface of the tops is black lacquered. It can be equipped with a cable management door.

Cable management door*.

- with cable management door
- without cable management door

Cable management door (where applicable). MDF flap door upholstered in

realizzato in fibra di legno a media densità e rivestito in pelle o cuoio in abbinamento al top o al sottomano (per le versioni con piano in legno). Consente l'uscita dei cavi elettrici e dà accesso a un tunnel passacavi in lamiera sagomata e a un doppio vano interno al piano. Il vano è fornito con una borchia passacavi nera ed è ulteriormente equipaggiabile con un dispositivo di elettrificazione da acquistare separatamente. Tutte le parti metalliche a vista sono verniciate in colore nero.

Gambe. Realizzate in MDF e disponibili con impiallacciatura in rovere TW o rivestite in pelle o cuoio. Le gambe in pelle o cuoio sono dotate di uno sportello in alluminio, anch'esso rivestito, che nasconde l'area verticale di passaggio cavi. Le gambe in rovere sono disponibili in doppia versione, con e senza la predisposizione per il passaggio cavi. Piedini regolabili in materiale plastico nero.

Finitura gambe.

- Rovere naturale TW (70)
- Rovere naturale TW (70) con passacavi
- Rovere medio TW (71)
- Rovere medio TW (71) con passacavi
- Pelle Frau® ColorSphere® (SC)
- Cuoio Saddle Executive

Raccordo piano - gambe. La funzione di raccordo è affidata a dei telai in acciaio verniciati in colore nero. Al di sotto di questi, nelle versioni senza sportello passacavi, sono presenti pannelli in MDF verniciati nero a copertura del telaio.

REGULAR / ICONIC DESK WITH STORAGE UNIT

Configurazione con storage unit. I modelli con storage unit presentano una configurazione asimmetrica: da un lato la scrivania è sostenuta da un mobile, dall'altra da una gamba.

Mobile. Struttura in MDF. Il piano è impiallacciato in rovere TW in una delle due finiture disponibili. Il mobile è attrezzato con due cassette classificatori sul lato interno/utilizzatore e con uno vano con mensola e sportello accessibile sul lato esterno per una migliore fruizione dello spazio (vedi disegno tecnico dedicato). Ogni cassetto è organizzato con un cassetto interno. Lo sportello, apribile a 155°, dispone di chiusura ammortizzata ed è possibile eliminare o graduare la potenza di frenatura dell'anta grazie a un cursore predisposto su ogni cerniera. L'esterno del mobile, compresi i frontali dei cassetti, è rivestito in pelle o cuoio, e l'interno è verniciato nero.

Posizione mobile.

- Mobile a destra
- Mobile a sinistra

OPTIONAL E ACCESSORI

Optional.

- Senza accessori
- Con pannello di cortesia
- Con borchia passacavi*

*N.B. La borchia passacavi non è opzionale in caso di scelta del modello con sportello passacavi

Pannello di cortesia. In MDF rivestito completamente in pelle o cuoio in abbinamento alle altre parti in pelle o cuoio.

Borchia passacavi. Nelle versioni con gambe in pelle o in legno con passacavi è possibile attrezzare il piano con delle borchie in metallo. Queste consentono la fuoriuscita dei cavi sul piano di lavoro e sono disponibili in versione:

- Cromata
- Verniciata nera

Nel caso di piano in rovere TW la borchia può essere posizionata in posizione fissa a destra o a sinistra del sottomano. Nel caso di piano in pelle è possibile optare anche per un alloggio centrale in un'area predefinita.

leather or saddle-leather to match the top or the working pad (for versions with wooden top). Acts as an outlet for electrical cables and gives access to a cable passageway in moulded sheet metal and a double compartment inside the desktop. The compartment is provided with a black grommet and can be also equipped with an electrical device to be purchased separately. All visible metal parts are painted in a black colour.

Legs. Made in MDF and available veneered in oak TW or upholstered in leather or saddle-leather.

The leather or saddle-leather legs are equipped with an aluminium door, also upholstered, which hides the vertical cable management area. The oak legs are available in a double version, with or without arrangement for the cable management system. Adjustable feet in black plastic.

Legs finish.

- Natural oak TW (70)
- Natural oak TW (70) with cable management system
- Medium oak TW (71)
- Medium oak TW (71) with cable management system
- Pelle Frau® ColorSphere® (SC)
- Saddle Executive

Top - legs junction. The junction is formed by black-coloured painted steel frames. In the versions without a cable management door, below these black lacquered MDF panels are used to cover the frame.

REGULAR /ICONIC DESK WITH STORAGE UNIT

Configuration with storage unit. The Desk version features an asymmetric design: it is supplied with a storage unit, supporting one of the two sides, and a leg.

Storage unit. Made of MDF. The top is veneered oak TW in one of two available finishes. The storage unit is equipped with two filing compartment drawers on the inner/user side and one compartment with a shelf and door accessible from the outer side for better use of space (see the dedicated technical drawing). Each drawer is organised with an inner drawer. The door opens at 155°, has a soft closing mechanism whose closing force can be regulated with a slider placed on each hinge. The exterior of the storage unit, including the front surfaces of the drawers, is upholstered in leather or saddle-leather, and the interior is black lacquered.

Storage unit position.

- Right-hand unit
- Left-hand unit

OPTIONAL ACCESSORIES

Accessories.

- Without accessories
- With modesty panel
- With cable grommet*

*N.B. The cable grommet is not selectable if the model with cable management door is chosen

Modesty panel. In MDF completely upholstered in leather or saddle-leather in combination with the other parts in leather or saddle-leather.

Cable grommet. The versions with leather legs or wood legs with cable management system can come with a top equipped with metal grommets. These allow the cables out onto the work top and are available in the following versions:

- Chrome finishing
- Black stained finishing

With the top in oak TW, the grommet can be placed in a fixed position to the right or left of the working pad. With the top in leather, the grommet can also be placed centrally in a predetermined area. To ensure the correct placement

Per assicurare una corretta predisposizione del foro in fase produttiva si raccomanda l'invio di un disegno.

Nelle versioni con storage unit e gamba in rovere TW senza passacavi la borchia può essere posizionata solo lato storage unit o anche centralmente in caso di piano in pelle. (vedi disegno tecnico dedicato).

SMALL DESK / SMALL DESK CON STORAGE UNIT

Piano.

- Pelle Frau® ColorSphere® (SC)
- Saddle Executive

Finitura gambe.

- Rovere naturale TW (70)
- Rovere medio TW (71)
- Pelle Frau® ColorSphere® (SC)
- Saddle Executive

Cassettiera (nel modello con storage unit). Struttura in MDF. Il top, impiallacciato in rovere TW in abbinamento alle gambe, presenta una fresatura per permettere l'uscita dei cavi elettrici dal cassetto interno (quando questa predisposizione viene richiesta come optional). La cassetteria è attrezzata con un cassetto classificatore esterno e un cassetto interno. La superficie esterna, compreso il cassetto, e il frontale del cassetto interno sono rivestiti in pelle o cuoio in abbinamento al piano della scrivania. L'interno della cassetteria è verniciato nero.

Posizione cassetteria.

- Cassetteria a destra
- Cassetteria a sinistra

Predisposizione passaggio cavi DI SERIE. La colonna di collegamento tra storage unit e top è verniciata color nero e presenta uno sportello laterale utile al passaggio dei cavi elettrici.

Optional (nel modello con storage unit).

- Senza accessori
- Predisposizione cassetto superiore per alloggio prese elettriche

Predisposizione passaggio cavi. Fornita e personalizzata in base ai dispositivi di elettrificazione scelti e specificati dal cliente in fase di acquisto. Tali dispositivi devono essere acquistati e installati dal cliente successivamente alla consegna. Per assicurare una corretta predisposizione in fase produttiva si raccomanda l'invio di un campione.

Nella stessa collezione.

Trust Cabinet
Trust Screen

of the hole during production phase, it is advisable to send a drawing. In the versions with a storage unit and leg in oak TW without cable management system, the grommet can only be placed on the side of the storage unit or centrally if the top is in leather. (see the dedicated technical drawing).

SMALL DESK / SMALL DESK WITH STORAGE UNIT

Top.

- Pelle Frau® ColorSphere® (SC) C
- Saddle Executive

Leg finish.

- Natural oak TW (70)
- Medium oak TW (71)
- Pelle Frau® ColorSphere® (SC)
- Saddle Executive

Drawer chest (in the item with storage unit). Structure in MDF. The top is veneered oak TW to match the legs and has a groove for the electrical cables coming through the inner drawer (when this option is requested). The drawer chest is equipped with an external filing compartment drawer and an inner drawer. The outer surface, including the drawer, and the front surface of the inner drawer are upholstered in leather or saddle-leather to match the top of the desk. The inside of the drawer chest is black lacquered.

Drawer unit position.

- Right-hand drawer unit
- Left-hand drawer unit

SERIES cable management arrangement. The column connecting the storage unit to the top has a black coloured lacquer and a side door which is useful for the passage of electric cables.

Optional (in the item with storage unit).

- Without accessories
- Arrangement of top drawer for housing electrical sockets

Arrangement for the cable management system. It is supplied and personalised based on the electrical devices chosen and specified by the customer at the time the order is placed. These devices must be purchased and installed by the client following delivery. To ensure proper placement during the production process, customers are strongly encouraged to submit a sample.

In the same collection.

Trust Cabinet
Trust Screen

REGULAR DESK - ICONIC DESK

APPOGGI A TERRA / SUPPORTS

GAMBE / LEGS



rovere / oak



rovere con passacavi
oak with cable management area



pele o cuoio (con passacavi)
leather or saddle-leather (with cable management area)

STORAGE UNIT

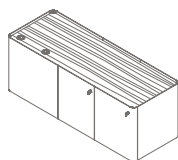

E' possibile sostituire una delle due gambe con lo storage unit. Disponibile solo in abbinamento ai piani di dimensioni 214×107.

It is possible to replace one of the two legs with the storage unit. Available only in combination with the 214×107 size tops.

PIANI / TOPS

LEGNO / WOOD

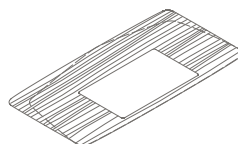

rovere con sottomano in pelle o cuoio
oak with leather or saddle leather working pad

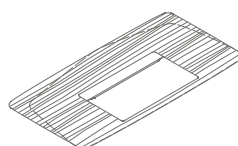

rovere con sottomano in pelle o cuoio e sportello passacavi
oak with leather or saddle leather working pad and cable management door

PELLE o CUOIO / LEATHER or SADDLE-LEATHER

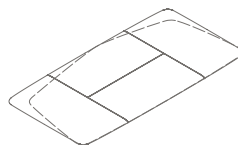

pele o cuoio
leather or saddle leather

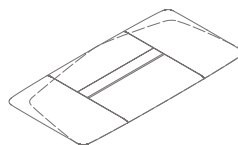

pele o cuoio con sportello passacavi
leather or saddle leather with cable management door

N.B. I piani qui mostrati sono disponibili in più dimensioni, due di forma Regular e 3 di forma Iconic.
Please Note. The tops here shown are available in multiple sizes, two in the Regular shape and 3 in the Iconic shape.

CONFIGURAZIONI SIMMETRICHE (senza storage unit) / SYMMETRIC CONFIGURATIONS (without storage unit)

REGULAR

ICONIC

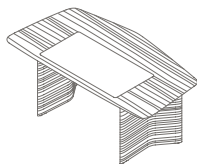
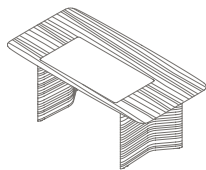

A

Piano in legno / *Wood top*
Sottomano in pelle o cuoio / *Leather working pad*
Gambe in legno / *Wood legs*

Optional:

Pannello di cortesia / *Modesty panel*

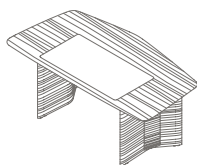
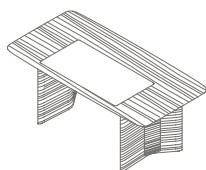

B

Piano in legno / *Wood top*
Sottomano in pelle o cuoio / *Leather working pad*
Gambe in legno con passacavi / *Wooden legs with cable management area*

Optional:

Pannello di cortesia / *Modesty panel*

Borchia passacavi / *Cable grommet*

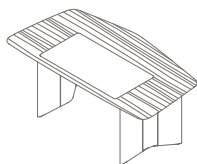
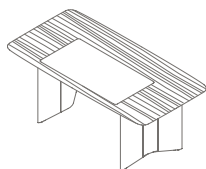

C

Piano in legno / *Wood top*
Sottomano in pelle o cuoio / *Leather working pad*
Gambe in pelle o cuoio / *Leather legs*

Optional:

Pannello di cortesia / *Modesty panel*

Borchia passacavi / *Cable grommet*

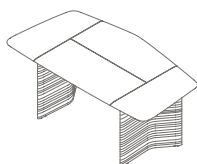
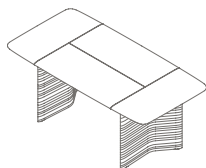

D

Piano in pelle o cuoio / *Leather top*
Gambe in legno / *Wood legs*

Optional:

Pannello di cortesia / *Modesty panel*

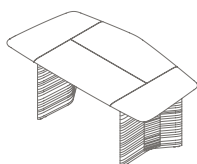
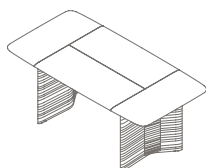

E

Piano in pelle o cuoio / *Leather top*
Gambe in legno con passacavi / *Wooden legs with cable management area*

Optional:

Pannello di cortesia / *Modesty panel*

Borchia passacavi / *Cable grommet*

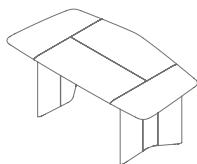
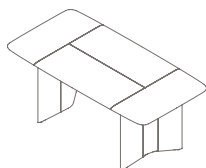

F

Piano in pelle o cuoio / *Leather top*
Gambe in pelle o cuoio / *Leather legs*

Optional:

Pannello di cortesia / *Modesty panel*

Borchia passacavi / *Cable grommet*

CONFIGURAZIONI SIMMETRICHE (senza storage unit) / SYMMETRIC CONFIGURATIONS (without storage unit)

REGULAR

ICONIC

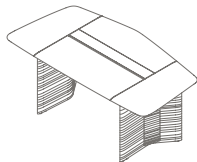
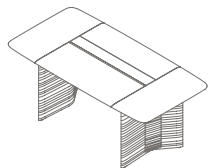

G

Piano in pelle o cuoio con sportello passacavi / *Leather top with cable management door*

Gambe in legno con passacavi / *Wooden legs with cable management area*

Optional:

Pannello di cortesia / *Modesty panel*

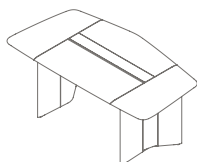
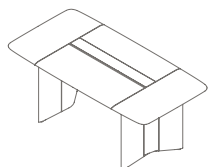

H

Piano in pelle o cuoio con sportello passacavi / *Leather top with cable management door*

Gambe in pelle o cuoio / *Leather legs*

Optional:

Pannello di cortesia / *Modesty panel*

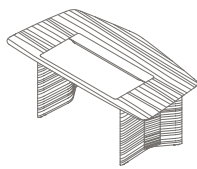
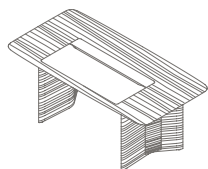

I

Piano in legno / *Wood top*

Sottomano in pelle o cuoio con sportello passacavi / *Leather working pad with cable management door*

Gambe in legno con passacavi / *Wooden legs with cable management area*

Optional:

Pannello di cortesia / *Modesty panel*

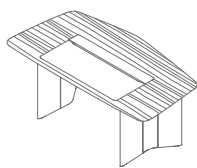
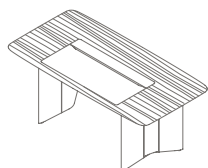

J

Piano in legno / *Wood top*

Sottomano in pelle o cuoio con sportello passacavi / *Leather working pad with cable management door*

Gambe in pelle o cuoio / *Leather legs*

Optional:

Pannello di cortesia / *Modesty panel*

CONFIGURAZIONI ASIMMETRICHE (con storage unit) / *ASYMMETRIC CONFIGURATIONS (with storage unit)*

REGULAR

ICONIC

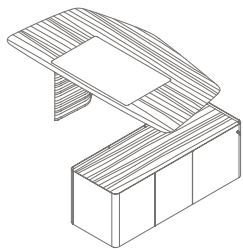
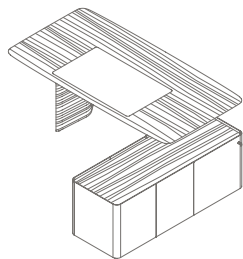

A

Piano in legno / *Wooden top*
Sottomano in pelle o cuoio / *Leather working pad*
Gamba in legno / *Wooden leg*

Optional:

Pannello di cortesia / *Modesty panel*
Borchia passacavi (solo lato storage unit) / *Cable grommet (only storage unit side)*

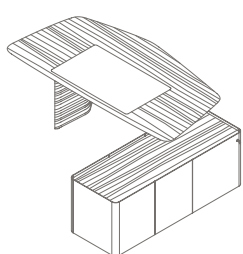
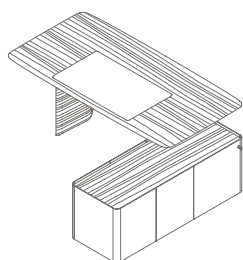

B

Piano in legno / *Wooden top*
Sottomano in pelle o cuoio / *Leather working pad*
Gamba in legno con passacavi / *Wooden leg with cable management area*

Optional:

Pannello di cortesia / *Modesty panel*
Borchia passacavi / *Cable grommet*

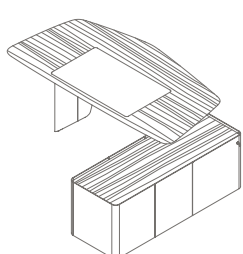
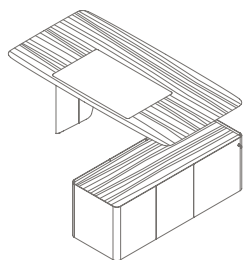

C

Piano in legno / *Wooden top*
Sottomano in pelle o cuoio / *Leather working pad*
Gamba in pelle o cuoio / *Leather leg*

Optional:

Pannello di cortesia / *Modesty panel*
Borchia passacavi / *Cable grommet*

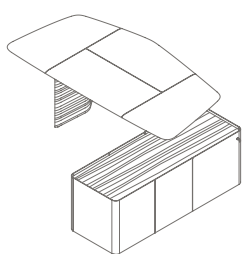
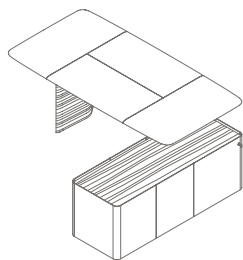

D

Piano in pelle o cuoio / *Leather top*
Gamba in legno / *Wooden leg*

Optional:

Pannello di cortesia / *Modesty panel*
Borchia passacavi (solo centrale o lato storage unit) / *Cable grommet (only central or storage unit positions)*

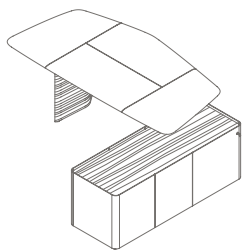
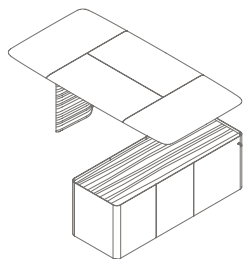

E

Piano in pelle o cuoio / *Leather top*
Gamba in legno con passacavi / *Wooden leg with cable management area*

Optional:

Pannello di cortesia / *Modesty panel*
Borchia passacavi / *Cable grommet*

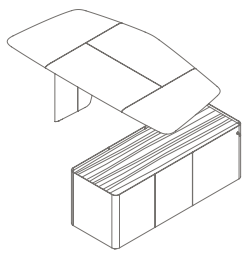
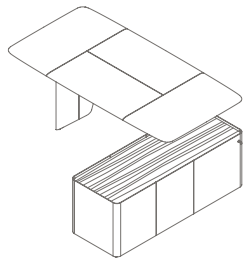

F

Piano in pelle o cuoio / *Leather top*
Gamba in pelle o cuoio / *Leather legs*

Optional:

Pannello di cortesia / *Modesty panel*
Borchia passacavi / *Cable grommet*

CONFIGURAZIONI ASIMMETRICHE (con storage unit) / *ASYMMETRIC CONFIGURATIONS (with storage unit)*

REGULAR

ICONIC

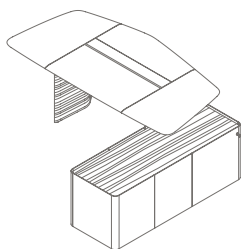
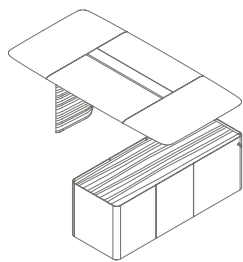

G

Piano in pelle o cuoio con sportello passacavi / *Leather top with cable management door*

Gamba in legno / *Wooden leg*

Optional:

Pannello di cortesia / *Modesty panel*

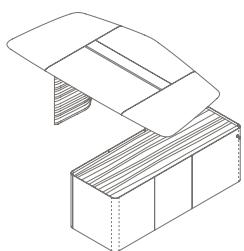
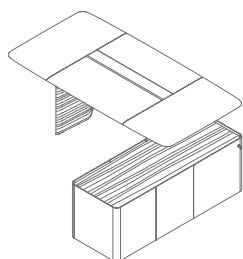

H

Piano in pelle o cuoio con sportello passacavi / *Leather top with cable management door*

Gamba in legno con passacavi / *Wooden leg with cable management area*

Optional:

Pannello di cortesia / *Modesty panel*

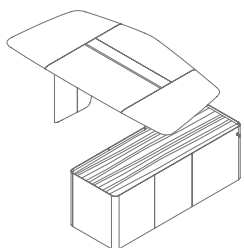
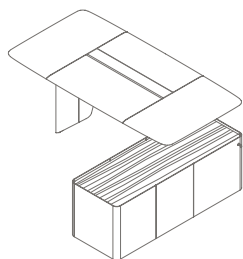

I

Piano in pelle o cuoio con sportello passacavi / *Leather top with cable management door*

Gamba in pelle o cuoio / *Leather leg*

Optional:

Pannello di cortesia / *Modesty panel*

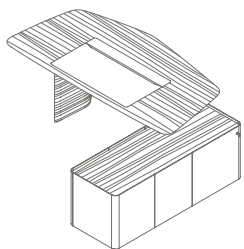
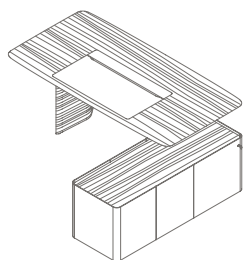

J

Piano in legno / *Wooden top*

Sottomano in pelle o cuoio con sportello passacavi / *Leather working pad with cable management door*

Gamba in legno / *Wooden leg*

Optional:

Pannello di cortesia / *Modesty panel*

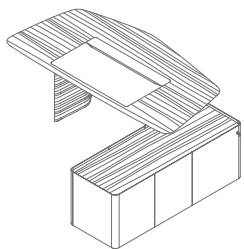
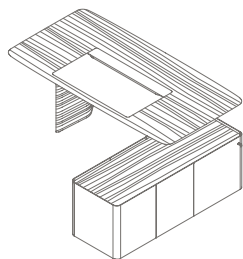

K

Piano in legno / *Wooden top*

Sottomano in pelle o cuoio con sportello passacavi / *Leather working pad with cable management door*

Gamba in legno con passacavi / *Wooden leg with cable management area*

Optional:

Pannello di cortesia / *Modesty panel*

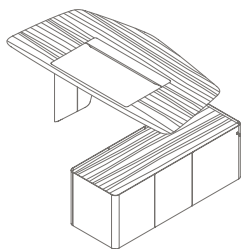
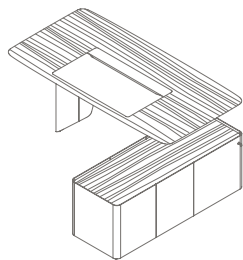

L

Piano in legno / *Wooden top*

Sottomano in pelle o cuoio con sportello passacavi / *Leather working pad with cable management door*

Gamba in pelle o cuoio / *Leather leg*

Optional:

Pannello di cortesia / *Modesty panel*

DISPONIBILE IN DUE DIMENSIONI / *AVAILABLE IN TWO DIMENSIONS:*

- 112 cm
- 130 cm

PANNELLO DI CORTESIA DA 112 cm / *112 cm COURTESY PANEL*

previsto per desk con configurazione simmetrica (senza storage unit) / *provided for symmetric desk (without storage unit)*

ESEMPIO: PANNELLO DI CORTESIA SU REGULAR DESK / *EXAMPLE: COURTESY PANEL ON REGULAR DESK*

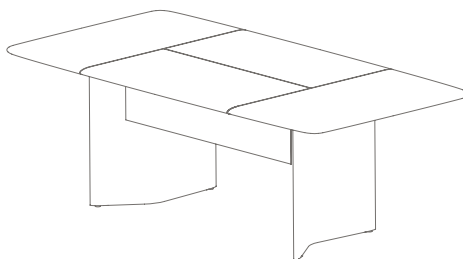
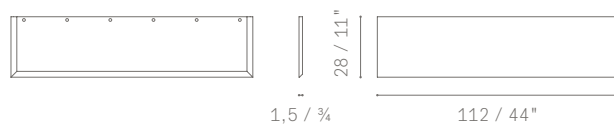

PANNELLO DI CORTESIA DA 130 cm / *130 cm COURTESY PANEL*

previsto per desk con configurazione asimmetrica (con storage unit) / *provided for asymmetric desk (with storage unit)*

ESEMPIO: PANNELLO DI CORTESIA SU REGULAR DESK WITH STORAGE UNIT / *EXAMPLE: COURTESY PANEL ON REGULAR DESK WITH STORAGE UNIT*

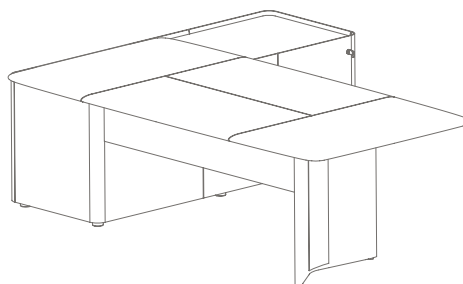
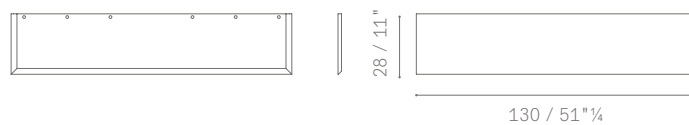

CONFIGURAZIONI SIMMETRICHE (senza storage unit) / SYMMETRIC CONFIGURATIONS (without storage unit)

Rappresentazione dello schema passaggio cavi nelle configurazioni con **PIANO IN LEGNO**
*Cable management representation in the configurations with **WOOD TOP***

B

Piano in legno / *Wood top*

Gambe in legno con passacavi / *Wooden legs with cable management area*

C

Piano in legno / *Wood top*

Gambe in pelle o cuoio / *Leather legs*

→ La borchia può essere posizionata in posizione fissa a destra o a sinistra del sottomano.
The grommet can be placed in a fixed position on the right or left of the working pad.

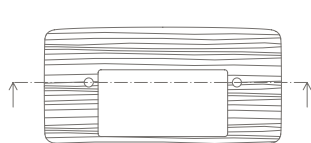
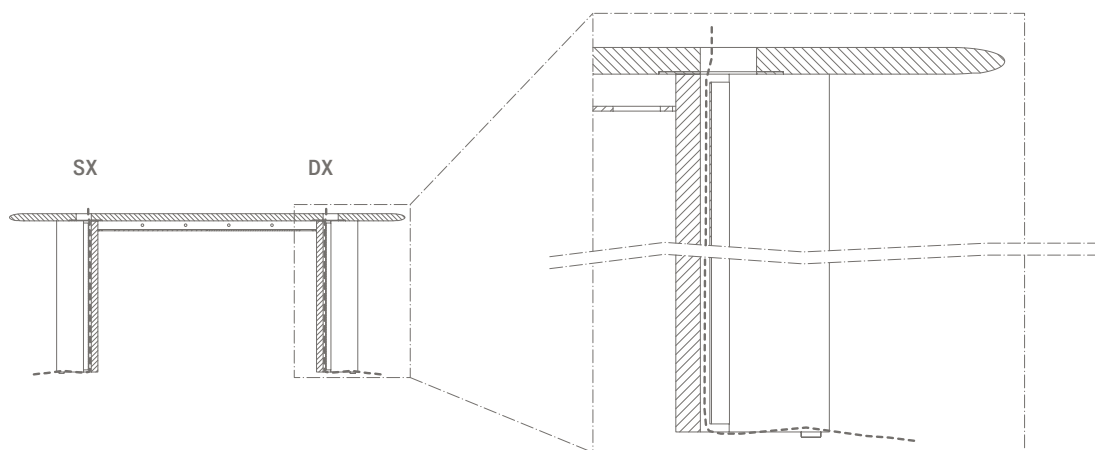

183×92 cm

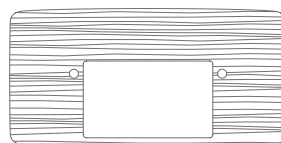

214×107 cm

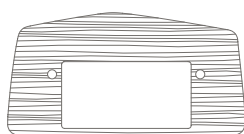

183×97 cm

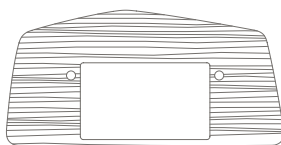

214×107 cm

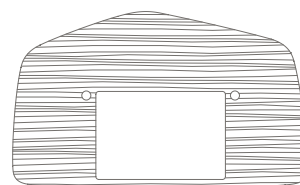

228×137 cm

CONFIGURAZIONI SIMMETRICHE (senza storage unit) / SYMMETRIC CONFIGURATIONS (without storage unit)

Rappresentazione dello schema passaggio cavi nelle configurazioni con **PIANO IN PELLE O CUOIO**
 Cable management representation in the configurations with **LEATHER TOP**

E

Piano in pelle o cuoio / *Leather top*
 Gambe in legno con passacavi / *Wooden legs with cable management area*

F

Piano in pelle o cuoio / *Leather top*
 Gambe in pelle o cuoio / *Leather legs*

→ La borchia può essere collocata in posizione fissa a destra o a sinistra del sottomano o, in alternativa, è possibile optare anche per un alloggiamento centrale a scelta all'interno dell'area tratteggiata. Per assicurare una corretta predisposizione del foro in fase produttiva si raccomanda l'invio di un disegno.
The grommet can be placed in a fixed position on the right or left of the working pad. Alternatively, it can also be placed centrally, in a location chosen within the dotted area. To ensure the correct placement of the hole during production phase, it is advisable to send a drawing.

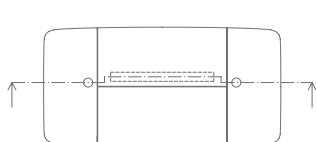
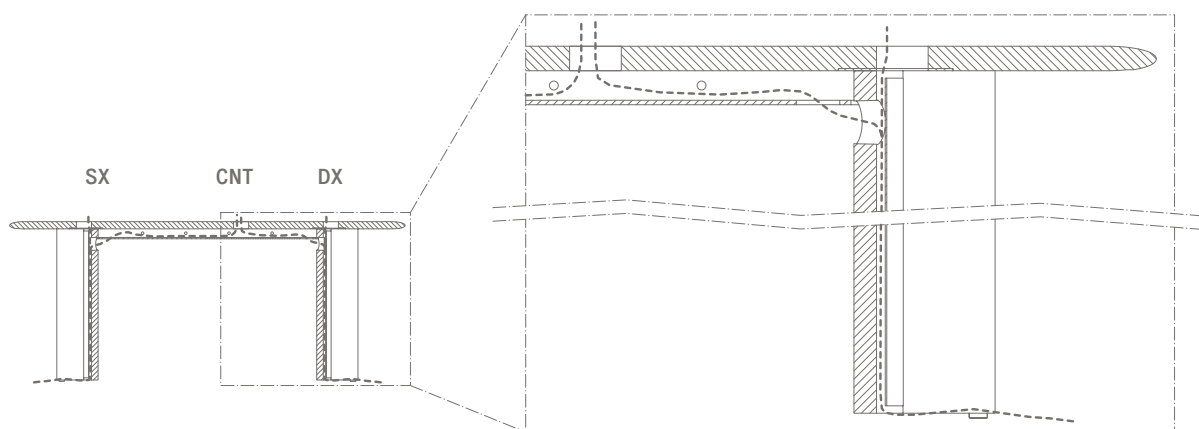

183×92 cm

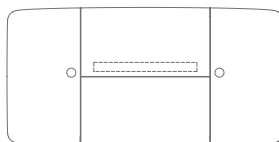

214×107 cm

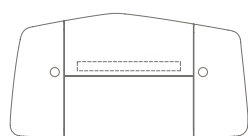

183×97 cm

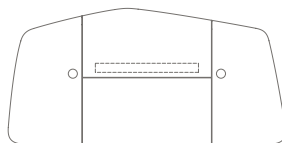

214×107 cm

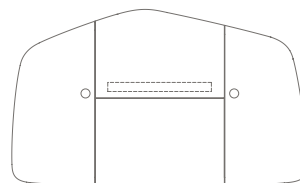

228×137 cm

CONFIGURAZIONI SIMMETRICHE (senza storage unit) / SYMMETRIC CONFIGURATIONS (without storage unit)

Rappresentazione dello schema passaggio cavi nelle configurazioni con sportello passacavi su **PIANO IN PELLE O CUOIO**
Cable management representation in the configurations with cable management door on **LEATHER TOP**

G

Piano in pelle o cuoio con sportello passacavi / *Leather top with cable management door*
Gambe in legno con passacavi / *Wooden legs with cable management area*

H

Piano in pelle o cuoio con sportello passacavi / *Leather top with cable management door*
Gambe in pelle o cuoio / *Leather legs*

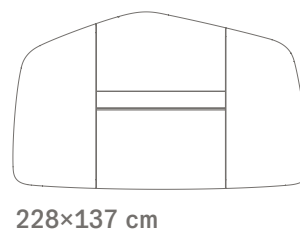
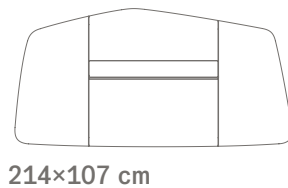
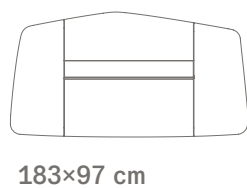
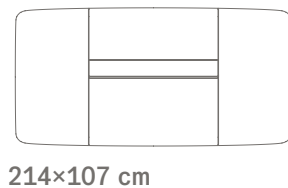
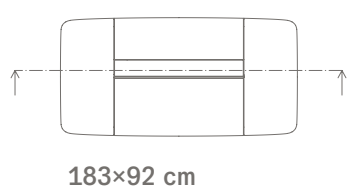
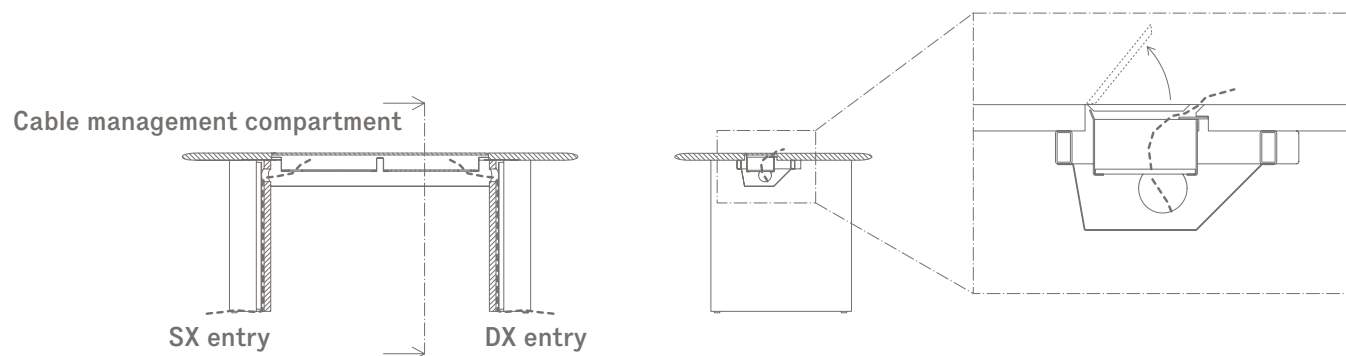

CONFIGURAZIONI SIMMETRICHE (senza storage unit) / SYMMETRIC CONFIGURATIONS (without storage unit)

Rappresentazione dello schema passaggio cavi nelle configurazioni con sportello passacavi su **PIANO IN LEGNO**
Cable management representation in the configurations with cable management door on **WOODEN TOP**

I
Piano in legno / Wood top
Sottomano in pelle o cuoio con sportello passacavi / Leather working pad with cable management door
Gambe in legno con passacavi / Wooden legs with cable management area

J
Piano in legno / Wood top
Sottomano in pelle o cuoio con sportello passacavi / Leather working pad with cable management door
Gambe in pelle o cuoio / Leather legs

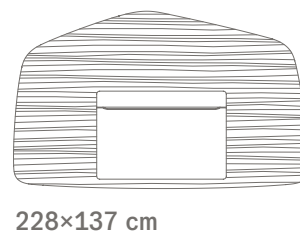
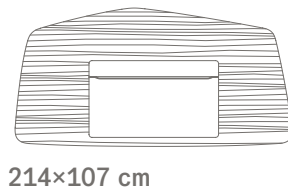
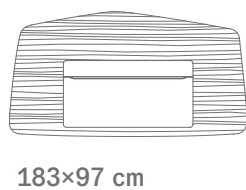
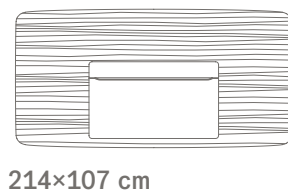
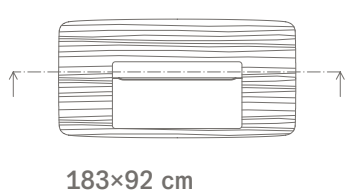
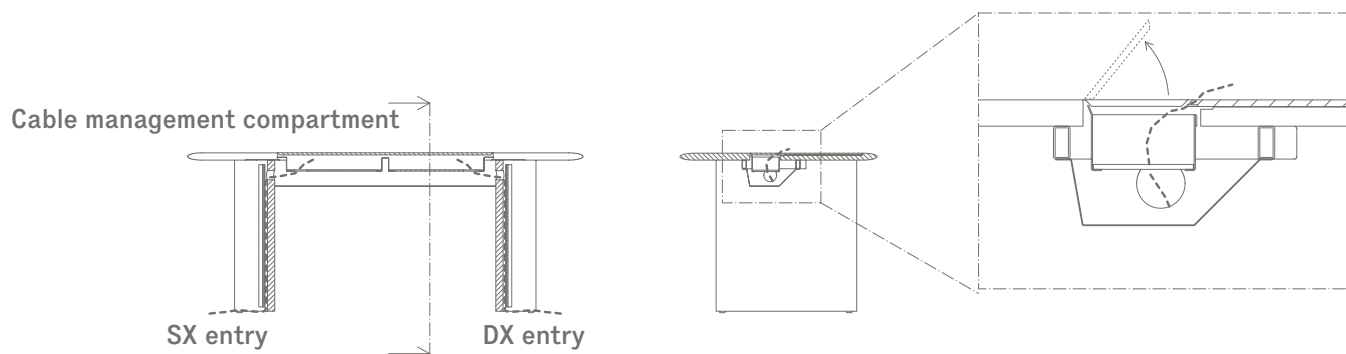

CONFIGURAZIONI ASIMMETRICHE (con storage unit) / ASYMMETRIC CONFIGURATIONS (with storage unit)

Rappresentazione dello schema passaggio cavi nelle configurazioni con **PIANO IN LEGNO O PELLE SENZA SPORTELLLO PASSACAVI**
Cable management representation in the configurations with wood or LEATHER TOP WITHOUT CABLE MANAGEMENT DOOR

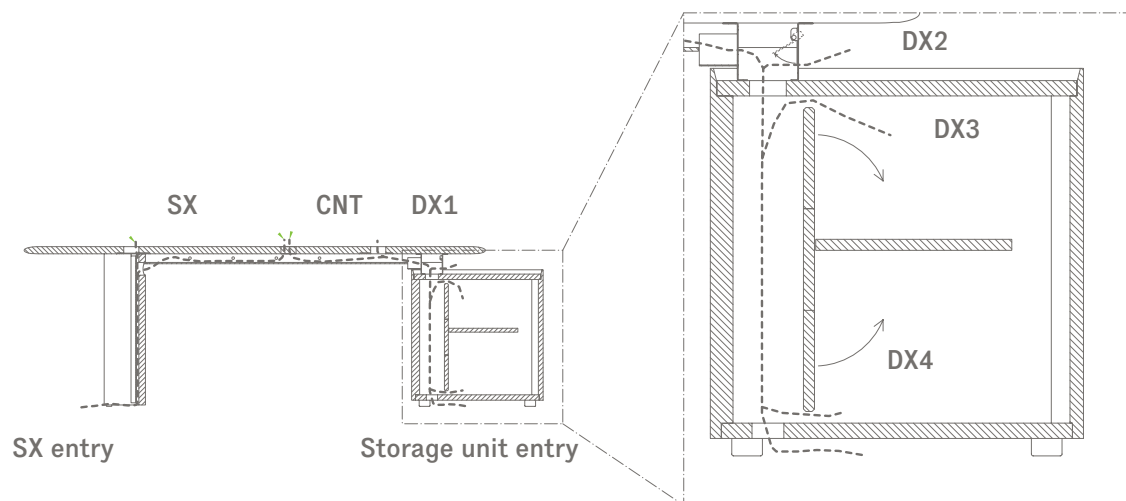

N.B. il disegno rappresenta il passaggio cavi di una scrivania con storage unit a destra.
Please Note the drawing represents the cable management for a desk with storage unit on the right.

- DX** (STORAGE UNIT) Uscite a DX (1-2-3-4) / *Right exit (1-2-3-4)*
 Passaggio cavi sempre disponibile / *Cable management always available*
 → **configurazioni / configurations A-B-C-D-E-F**
 - CNT** Uscita centrale con filo proveniente da gamba sinistra / *Central exit with cable coming from the left leg*
 Passaggio cavi disponibile solo con gamba in pelle o cuoio o in legno passacavi + piano in pelle o cuoio / *Cable management available only with leather leg or wooden leg with cable management area + leather top*
 → **solo nella configurazione / only configuration E-F**
 - CNT** Uscita centrale con filo proveniente dallo storage unit / *Central exit with cable coming from the storage unit*
 Passaggio cavi disponibile solo con piano in pelle o cuoio / *Cable management available only with leather top*
Per assicurare una corretta predisposizione del foro in fase produttiva si raccomanda l'invio di un disegno / To ensure the correct placement of the hole during production phase, it is advisable to send a drawing
 → **solo nelle configurazioni / only configurations D-E-F**
 - SX** Uscita sinistra / *Left exit*
 Passaggio cavi disponibile solo con gamba in pelle o cuoio o in legno con passacavi / *Cable management available only with / leather leg or wooden leg with cable management area*
 → **solo nelle configurazioni / only configurations B-C-E-F**
- **Nelle configurazioni con storage unit la borchia passacavi sul lato opposto allo storage unit è disponibile solo con gamba in pelle/cuoio (C-F) o con gamba in legno con passacavi (B-E).**
In the configurations with storage unit, the cable grommet on the opposite side of the storage unit is only available with the leg in leather/saddle-leather (C-F) or with wooden leg with cable management area (B-E)

Configurations A - B - C

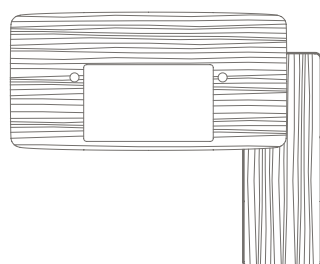

Configurations D - E - F

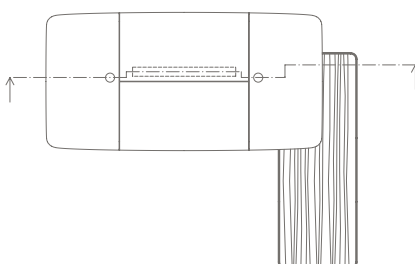

CONFIGURAZIONI ASIMMETRICHE (con storage unit) / ASYMMETRIC CONFIGURATIONS (with storage unit)

Rappresentazione dello schema passaggio cavi nelle configurazioni con **PIANO IN LEGNO O PELLE E SPORTELLO PASSACAVI**
Cable management representation in the configurations with wood or LEATHER TOP WITH CABLE MANAGEMENT DOOR

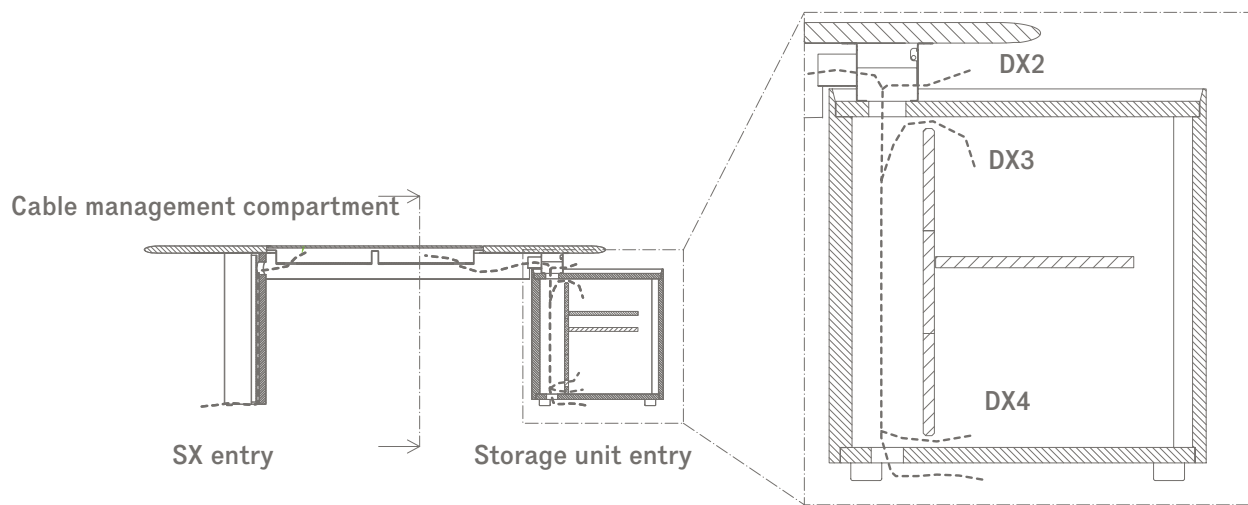

N.B. il disegno rappresenta il passaggio cavi di una scrivania con storage unit a destra.
Please Note the drawing represents the cable management for a desk with storage unit on the right.

DX (STORAGE UNIT)

Uscite a destra (2-3-4) / *Right exit (2-3-4)*

Passaggio cavi sempre disponibile / *Cable management always available*

→ configurazioni / *configurations* G-H-I-J-K-L

USCITA DAL VANO PASSACAVI / EXIT FROM THE CABLE MANAGEMENT COMPARTMENT

- con filo proveniente da gamba sinistra / *with cable coming from the left leg*

Passaggio cavi disponibile solo con gamba in pelle o cuoio o in legno con passacavi / *Cable management available only with leather leg or wooden leg with cable management area*

→ configurazioni / *configurations* H-I-K-L

- con filo proveniente dallo storage unit / *with cable coming from the storage unit*

Passaggio cavi sempre disponibile / *Cable management always available*

→ configurazioni / *configurations* G-H-I-J-K-L

Configurations G - H - I

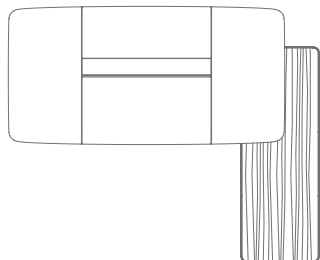

Configurations J - K - L

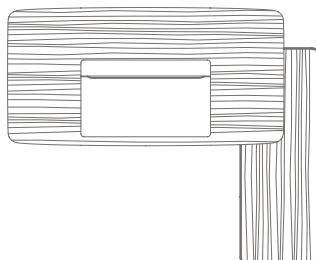

SMALL DESK 145×68cm

WITHOUT STORAGE UNIT

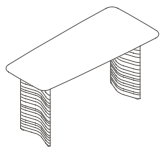

A

Piano in pelle o cuoio / *Leather top*
Gambe in legno / *Wood legs*

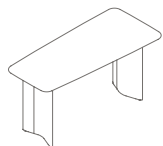

B

Piano in pelle o cuoio / *Leather top*
Gambe in pelle o cuoio / *Leather legs*

WITH STORAGE UNIT

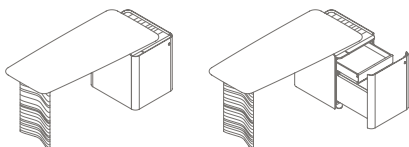

A

Piano in pelle o cuoio / *Leather top*
Gambe in legno / *Wood legs*
Fresatura del piano della cassetteria per uscita cavi dal cassetto /
Grooving of the drawer unit top for the cable management exit
Predisposizione passaggio cavi nella colonna di collegamento tra
storage unit e piano / *Cable management arrangement in the column*
connecting the storage unit and the top

Optional:

Predisposizione cassetto superiore per alloggiamento prese elettriche
Top drawer arrangement for housing electrical sockets

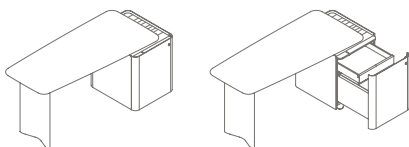

B

Piano in pelle o cuoio / *Leather top*
Gambe in pelle o cuoio / *Leather legs*
Fresatura del piano della cassetteria per uscita cavi dal cassetto /
Grooving of the drawer unit top for the cable management exit
Predisposizione passaggio cavi nella colonna di collegamento tra
storage unit e piano / *Cable management arrangement in the column*
connecting the storage unit and the top

Optional:

Predisposizione cassetto superiore per alloggiamento prese elettriche
Top drawer arrangement for housing electrical sockets

SMALL DESK con/with STORAGE UNIT

Rappresentazione dello schema passaggio cavi
Cable management representation in the configurations

DI SERIE / SERIES

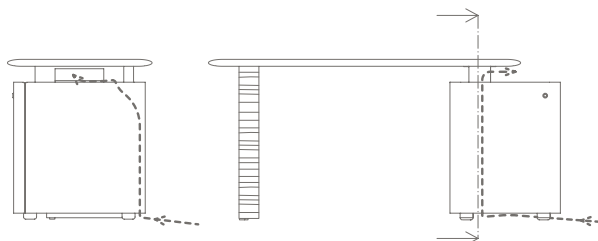

Il passaggio cavi avviene tramite uno sportellino sulla colonna di collegamento tra storage unit e piano.
Cables are channelled via a little flap on the column that connects the storage unit and the top.

OPTIONAL

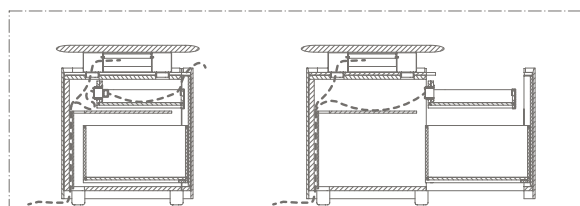

Il passaggio cavi avviene tramite il cassetto superiore portaprese. In questo caso i cavi elettrici provenienti dal cassetto possono uscire e passare attraverso una fresatura del piano della cassetteria.
Cables pass through the upper socket drawer. In this case the electric cables that emerge from the drawer can come out and pass through a groove on the top of the drawer unit.

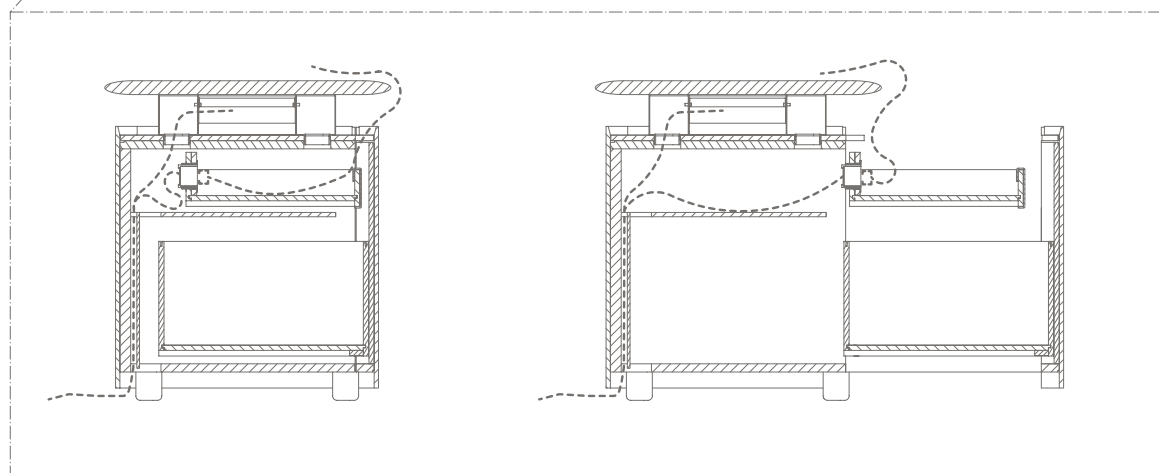

5644701 | A

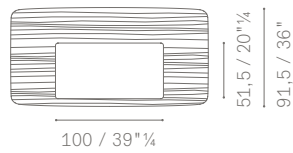

74 / 29 1/4
70.5 / 27 3/4

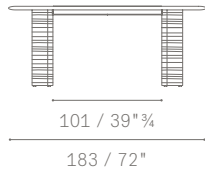
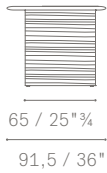

5644701 | B

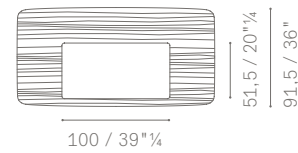

74 / 29 1/4
70.5 / 27 3/4

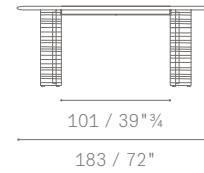
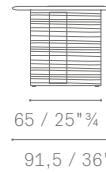

5644701 | C

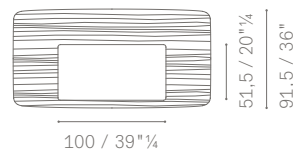

74 / 29 1/4
70.5 / 27 3/4

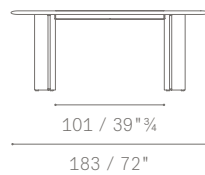
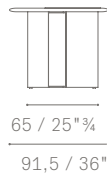

5644701 | D

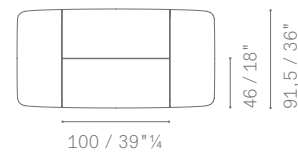

74 / 29 1/4
70.5 / 27 3/4

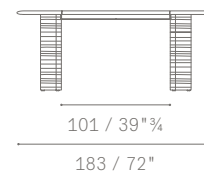
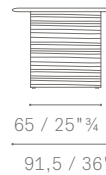

5644701 | E

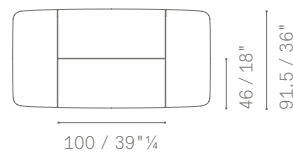

74 / 29 1/4
70.5 / 27 3/4

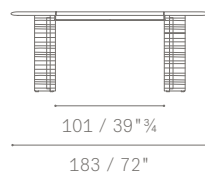
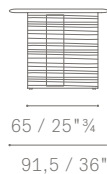

5644701 | F

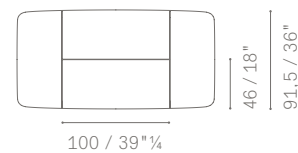

74 / 29 1/4
70.5 / 27 3/4

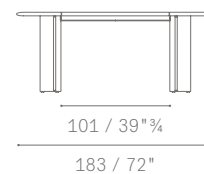
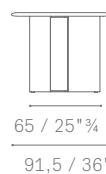

5644701 | G

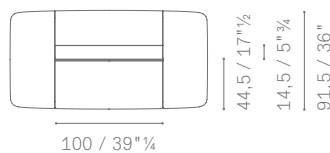

74 / 29 1/4
70.5 / 27 3/4

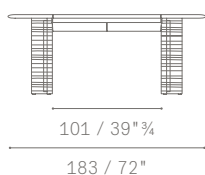
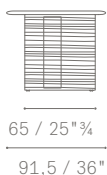

5644701 | H

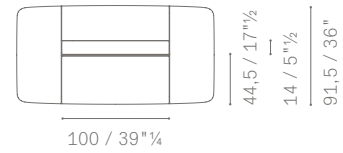

74 / 29 1/4
70.5 / 27 3/4

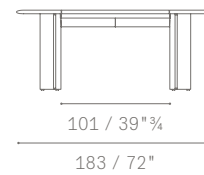
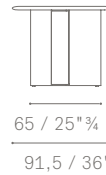

5644701 | I

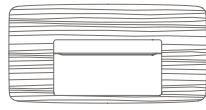

100 / 39"¼

37,5 / 14"¾

14 / 5"½

91,5 / 36"

74 / 29"¼
70,5 / 27"¾

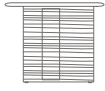

65 / 25"¾

91,5 / 36"



101 / 39"¾

183 / 72"

5644701 | J

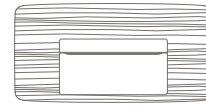

100 / 39"¼

37,5 / 14"¾

14 / 5"½

91,5 / 36"

74 / 29"¼
70,5 / 27"¾

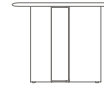

65 / 25"¾

91,5 / 36"

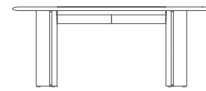

101 / 39"¾

183 / 72"

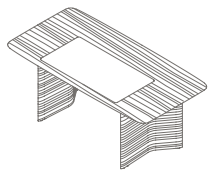

A

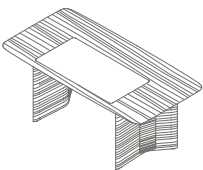

B

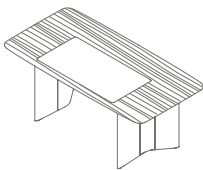

C

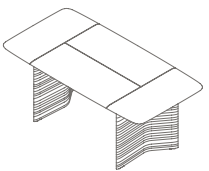

D

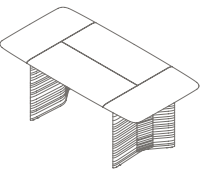

E

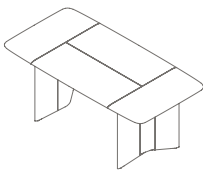

F

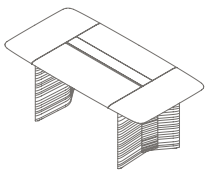

G

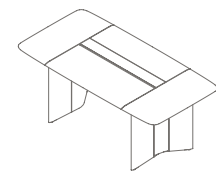

H

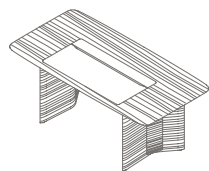

I

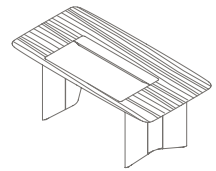

J

5644702 | A

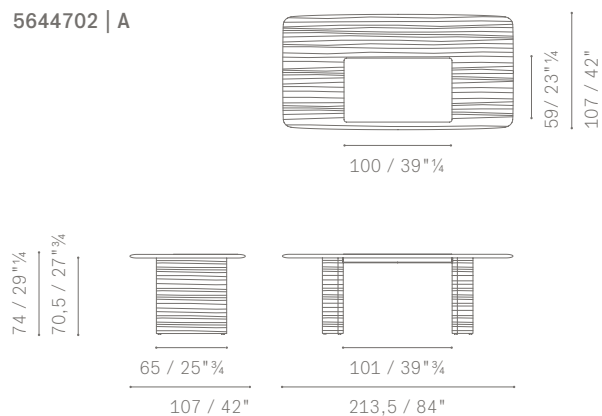

5644702 | B

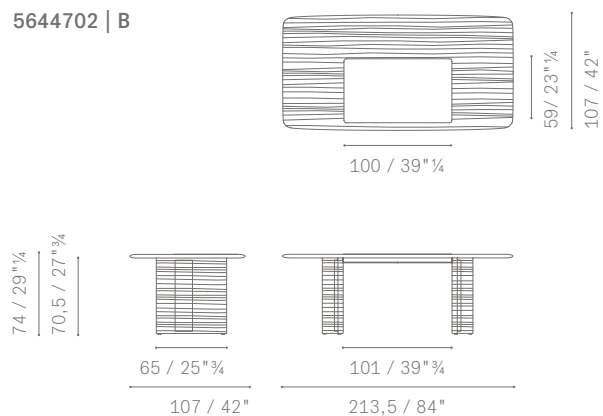

5644702 | C

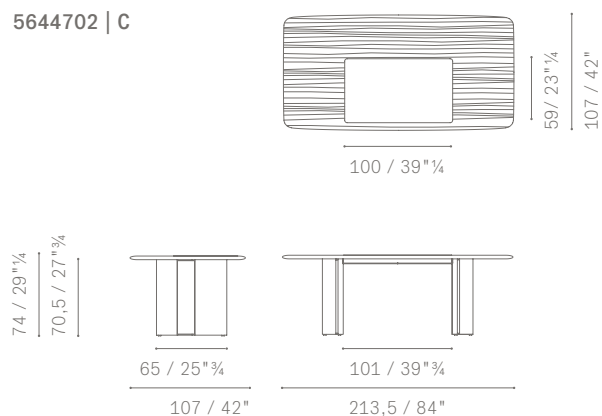

5644702 | D

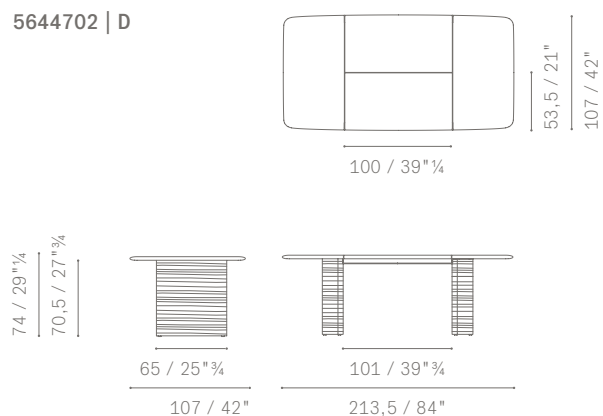

5644702 | E

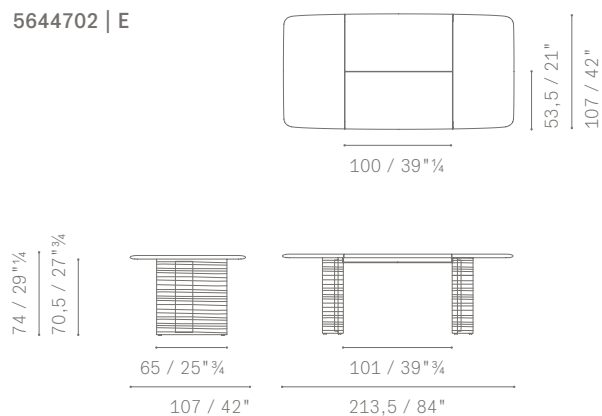

5644702 | F

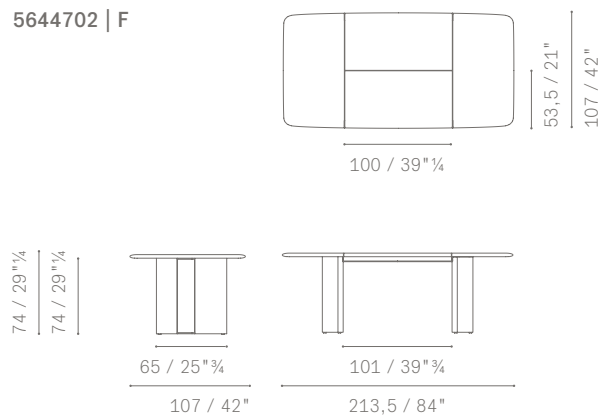

5644702 | G

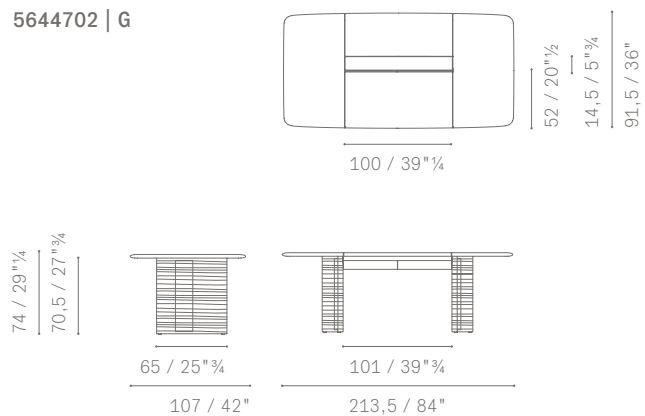

5644702 | H

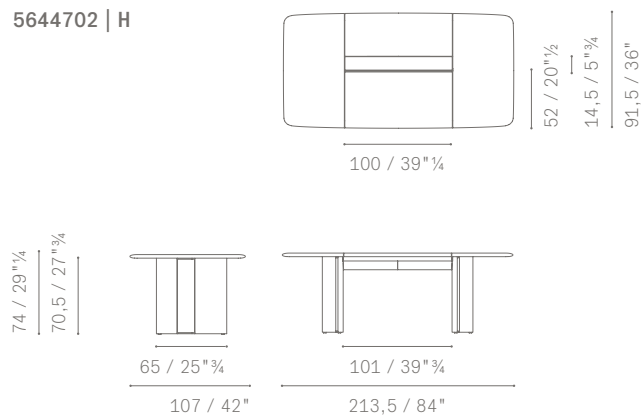

5644702 | I

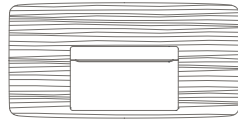

100 / 39"¼

45 / 17"¾
14 / 5"½
91,5 / 36"

74 / 29"¼
70,5 / 27"¾



65 / 25"¾

107 / 42"



101 / 39"¾

213,5 / 84"

5644702 | J

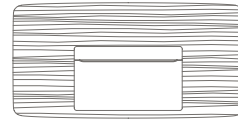

100 / 39"¼

45 / 17"¾
14 / 5"½
91,5 / 36"

74 / 29"¼
70,5 / 27"¾

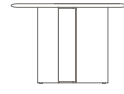

65 / 25"¾

107 / 42"

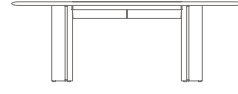

101 / 39"¾

213,5 / 84"

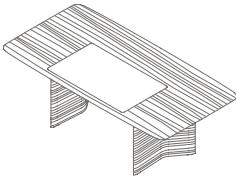

A

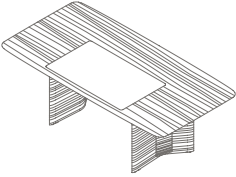

B

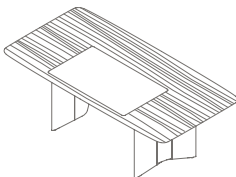

C

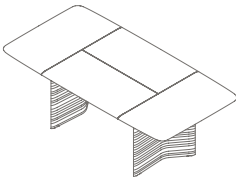

D

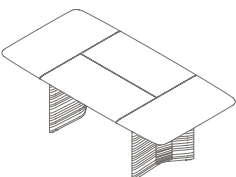

E

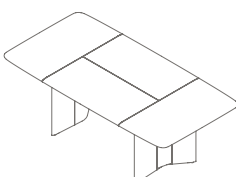

F

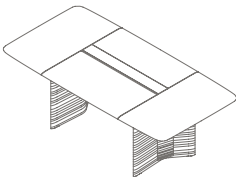

G

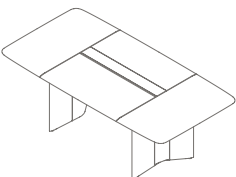

H

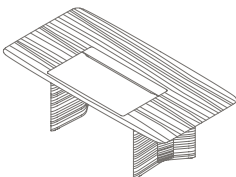

I

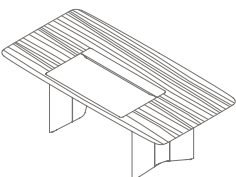

J

5644711 | A

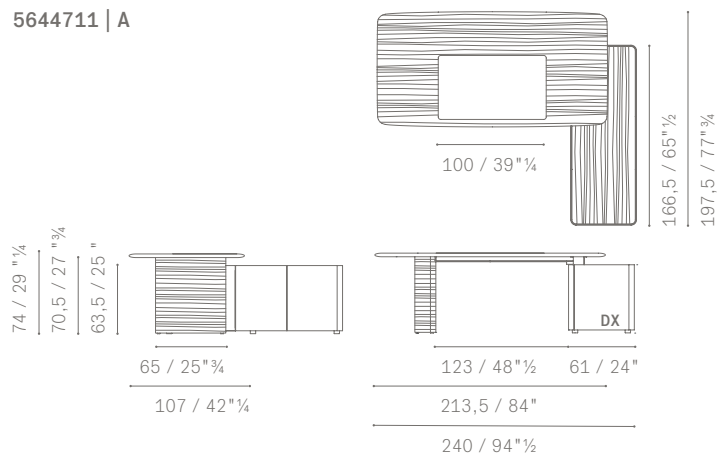

5644711 | B

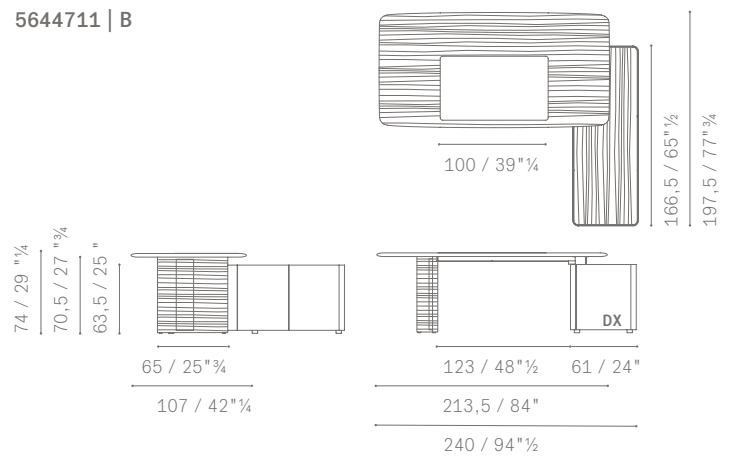

5644711 | C

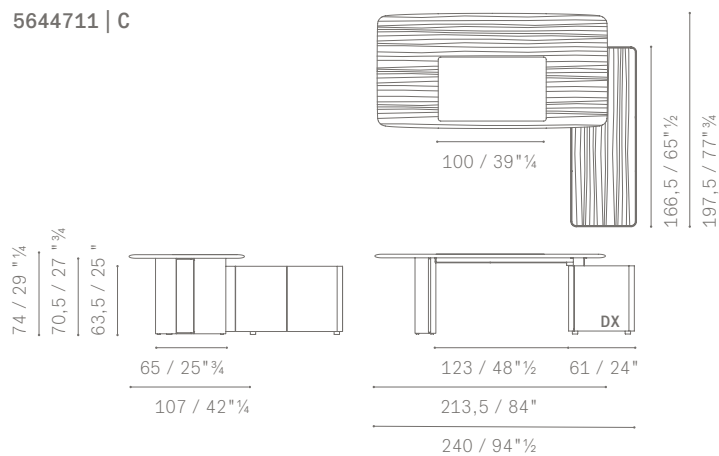

5644711 | D

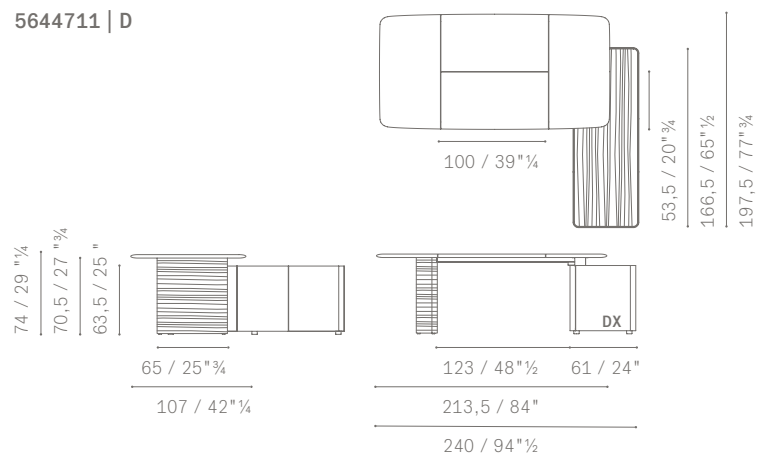

5644711 | E

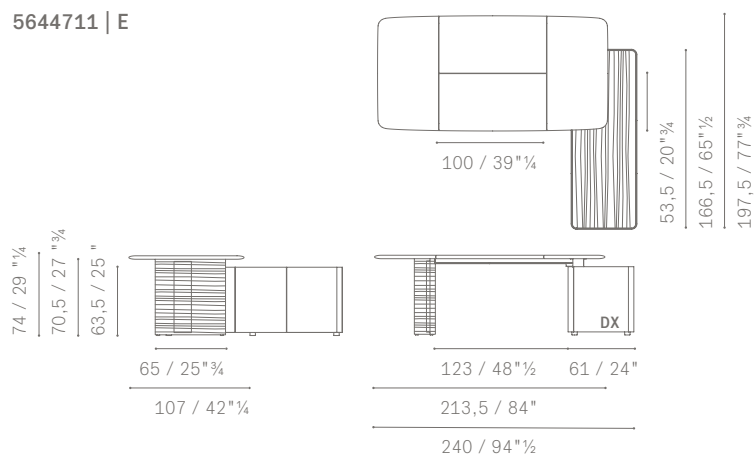

5644711 | F

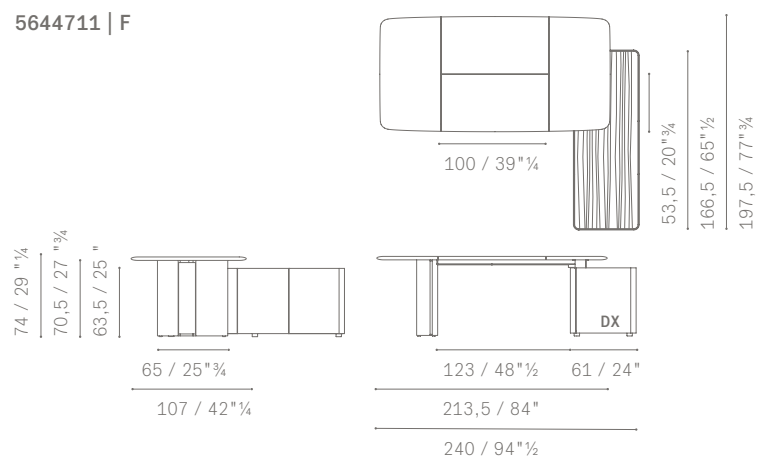

5644711 | G

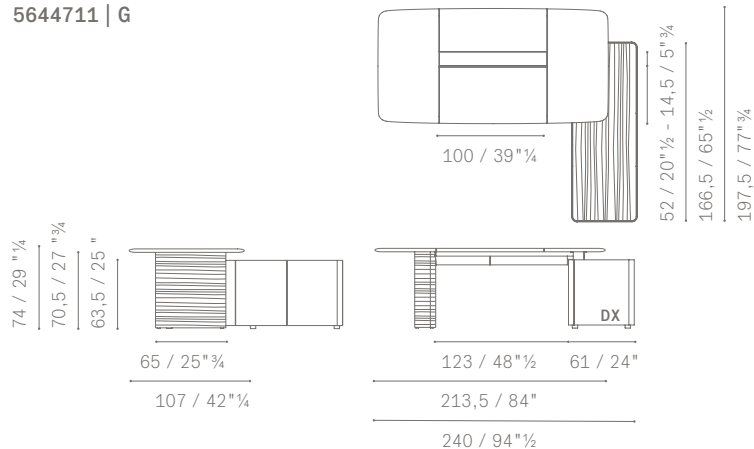

5644711 | H

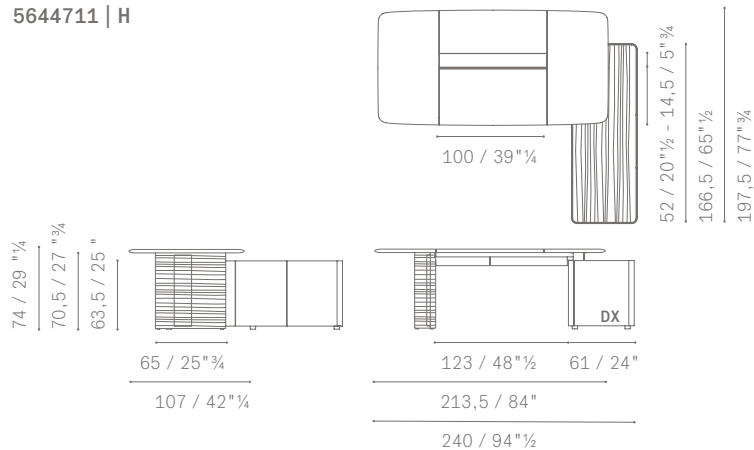

5644711 | I

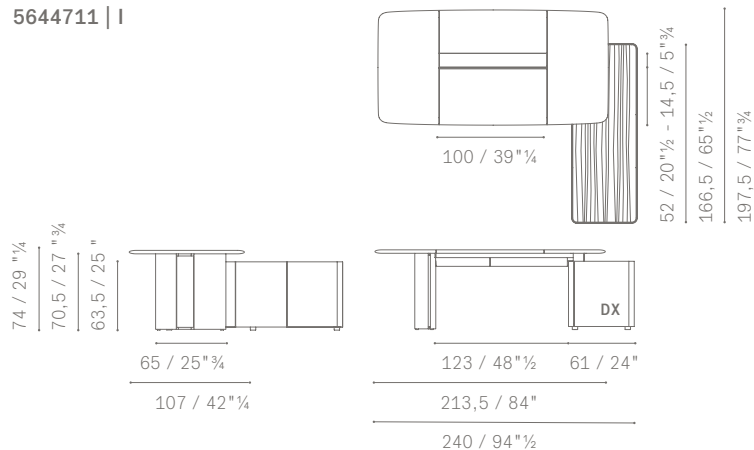

5644711 | J

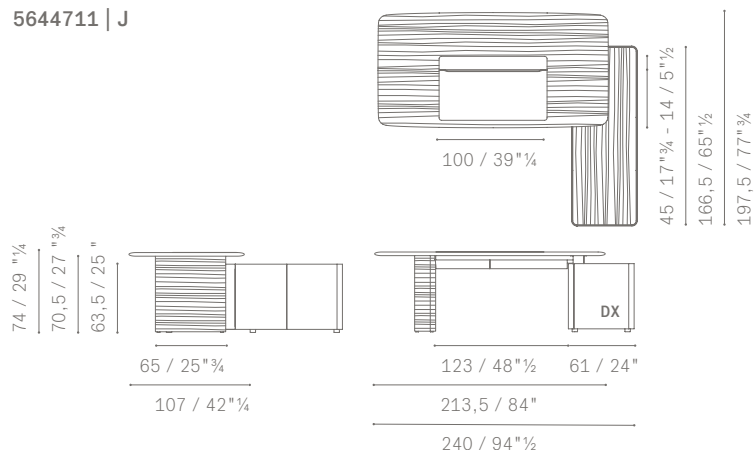

5644711 | K

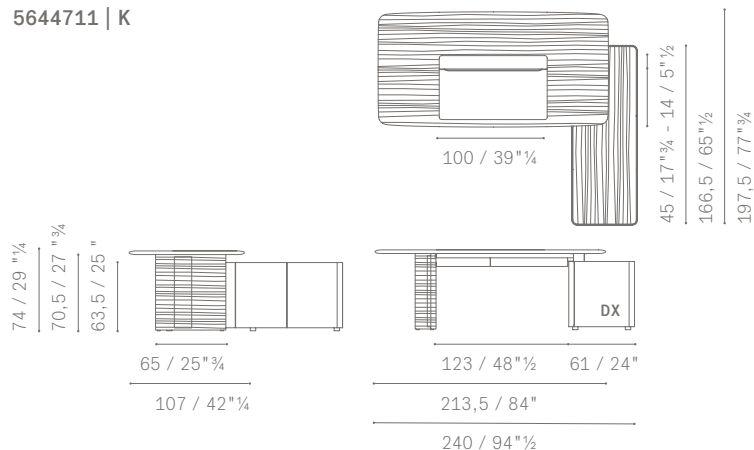

5644711 | L

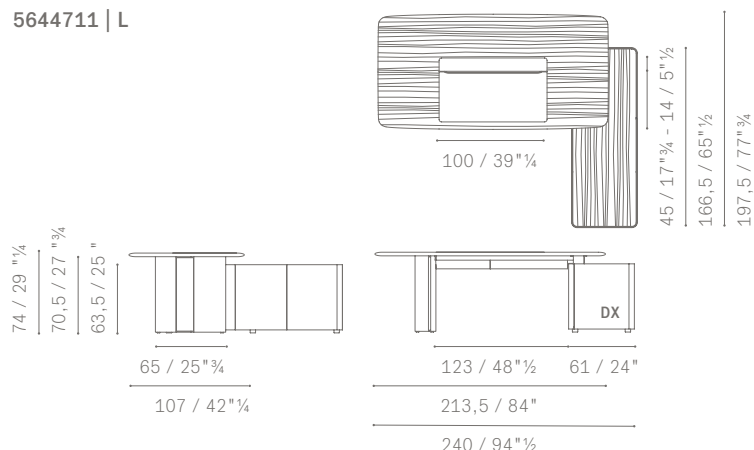

Legend: opening direction of drawers and door

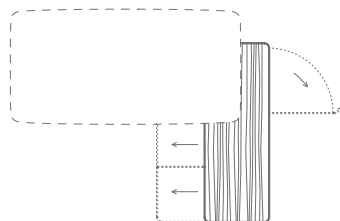

5644705 | A

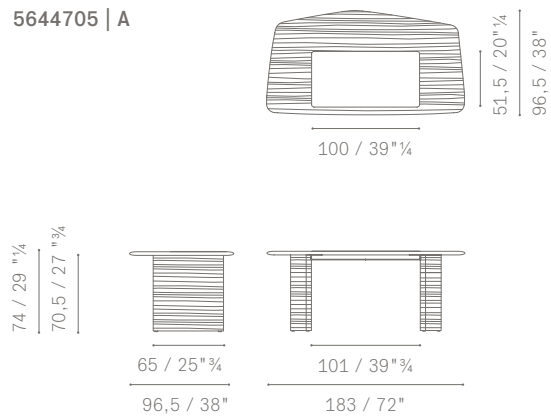

5644705 | B

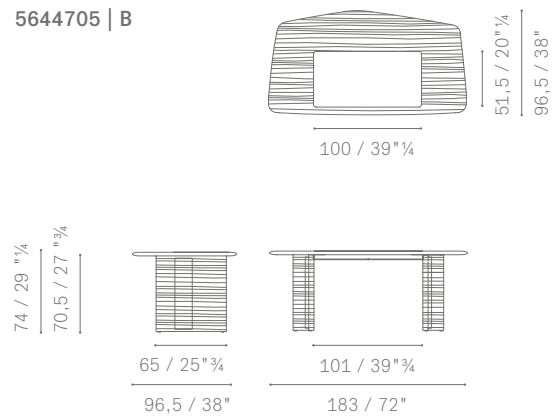

5644705 | C

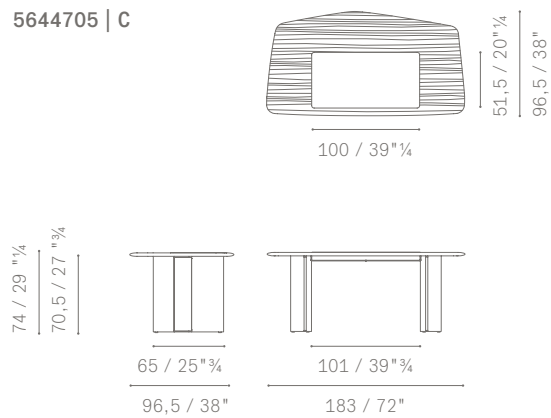

5644705 | D

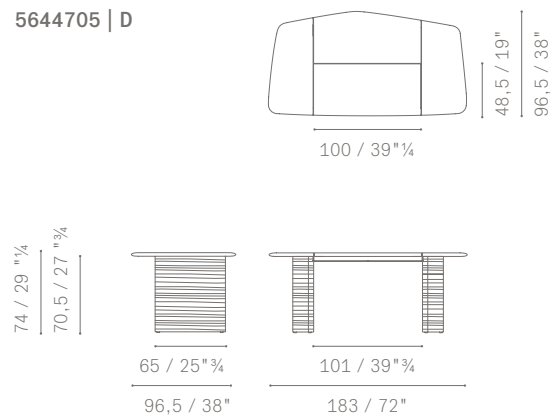

5644705 | E

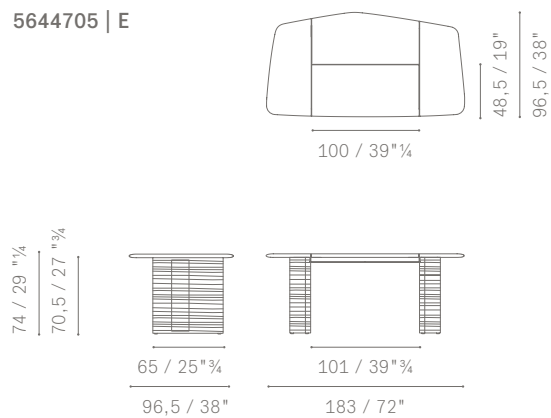

5644705 | F

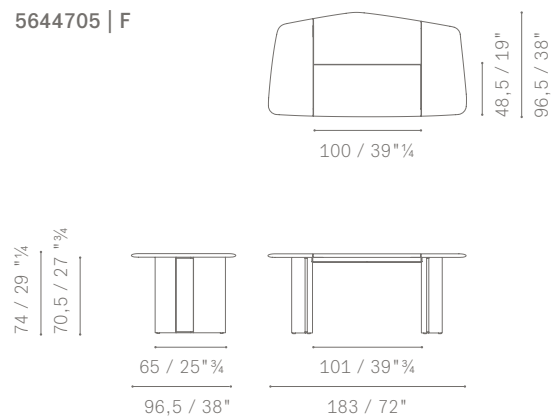

5644705 | G

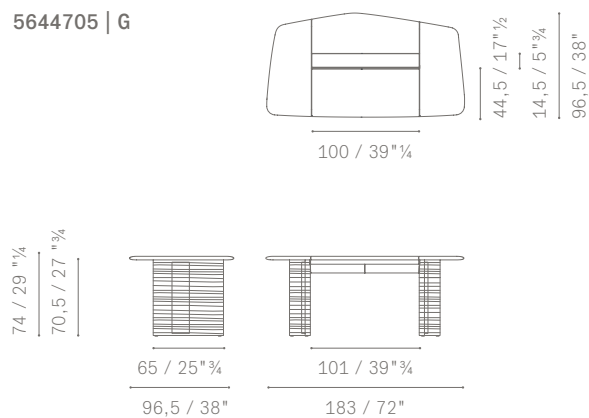

5644705 | H

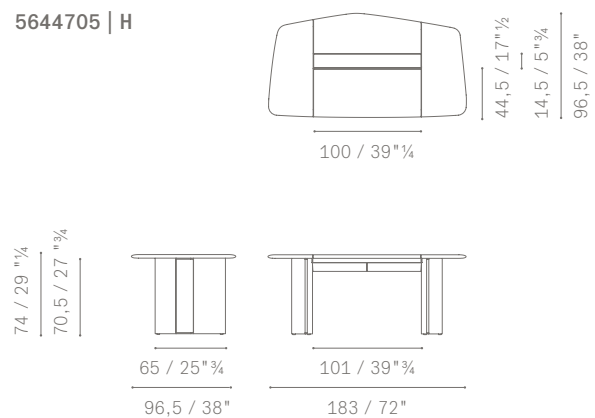

5644705 | I

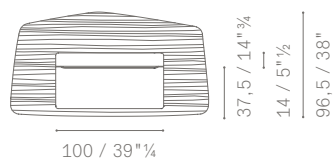

5644705 | J

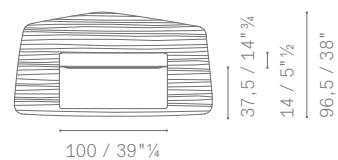

74 / 29"¾
70,5 / 27"¾

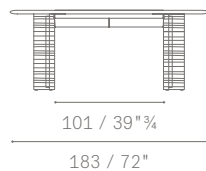
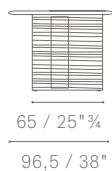

74 / 29"¾
70,5 / 27"¾

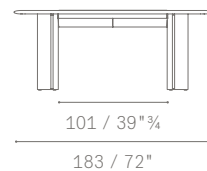
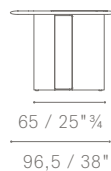

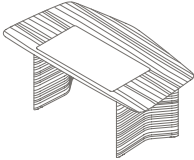

A

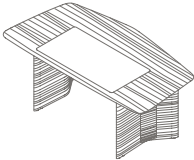

B

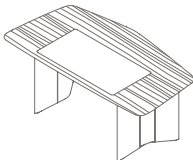

C

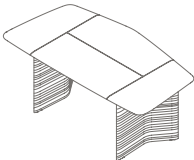

D

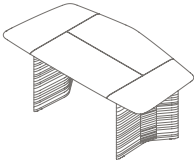

E

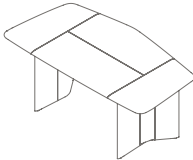

F

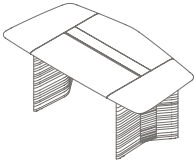

G

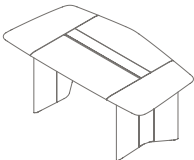

H

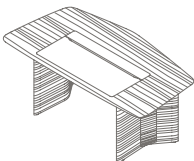

I

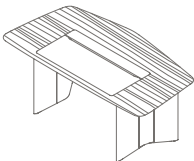

J

5644706 | A

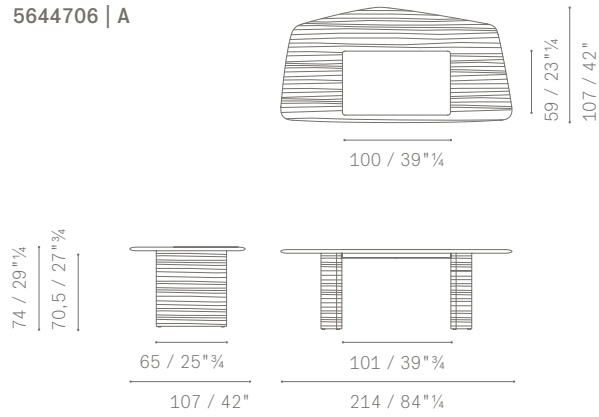

5644706 | B

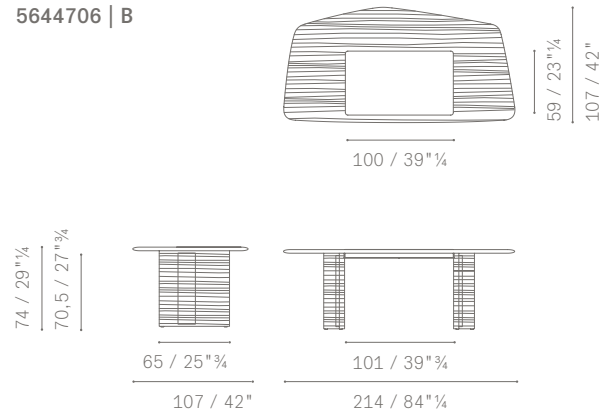

5644706 | C

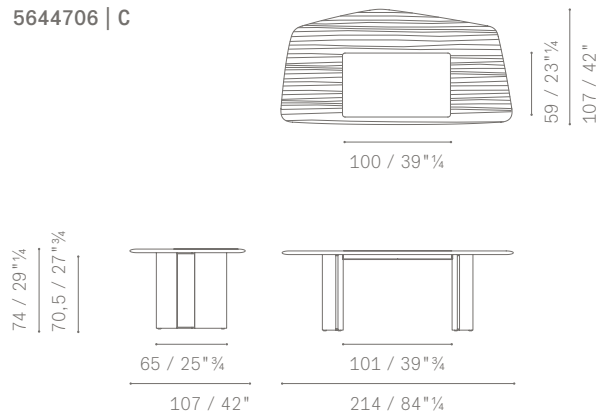

5644706 | D

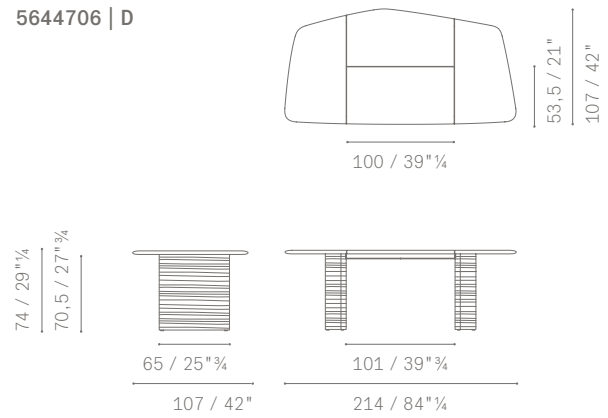

5644706 | E

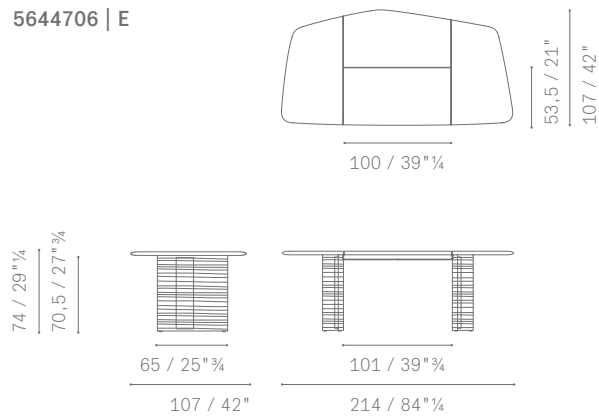

5644706 | F

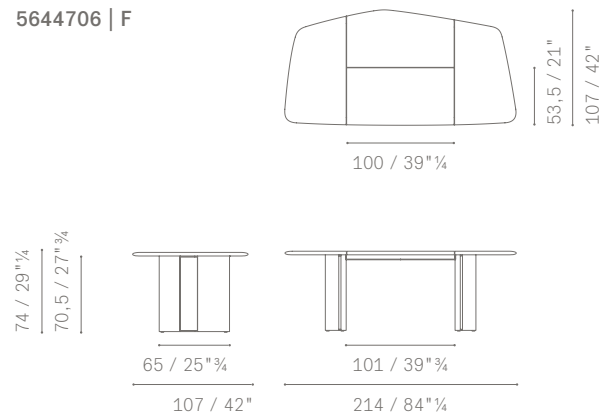

5644706 | G

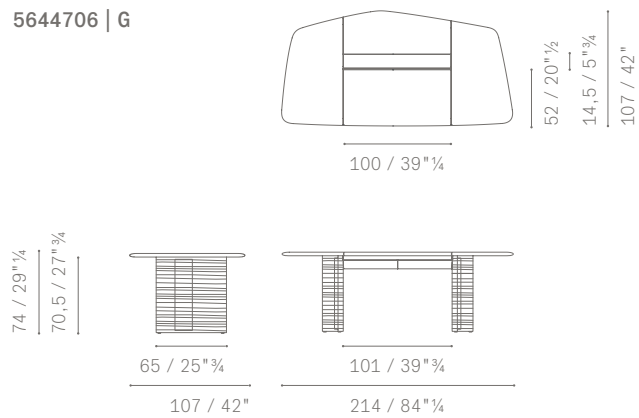

5644706 | H

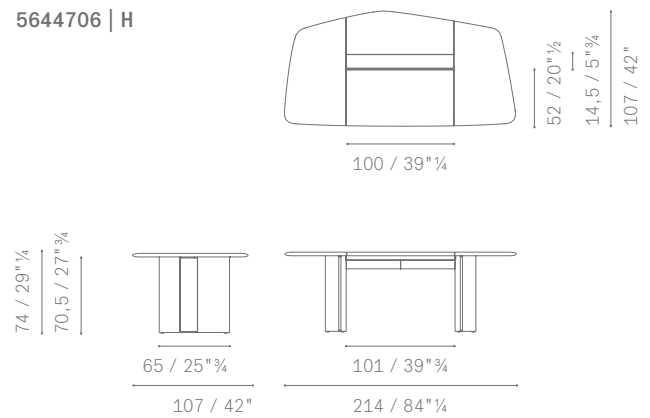

5644706 | I

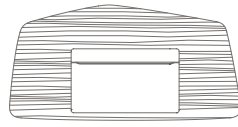

100 / 39" $\frac{1}{4}$

45 / 17" $\frac{3}{4}$
14 / 5" $\frac{1}{2}$
107 / 42"

74 / 29" $\frac{1}{4}$
70,5 / 27" $\frac{3}{4}$

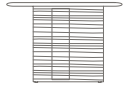

65 / 25" $\frac{3}{4}$

107 / 42"



101 / 39" $\frac{3}{4}$

214 / 84" $\frac{1}{4}$

5644706 | J

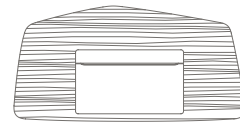

100 / 39" $\frac{1}{4}$

45 / 17" $\frac{3}{4}$
14 / 5" $\frac{1}{2}$
107 / 42"

74 / 29" $\frac{1}{4}$
70,5 / 27" $\frac{3}{4}$

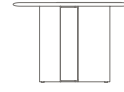

65 / 25" $\frac{3}{4}$

107 / 42"

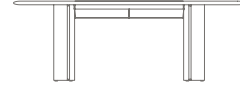

101 / 39" $\frac{3}{4}$

214 / 84" $\frac{1}{4}$

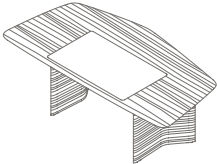

A

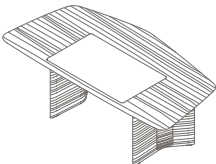

B

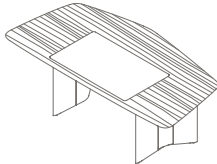

C

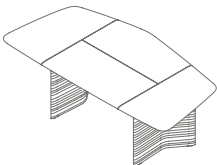

D

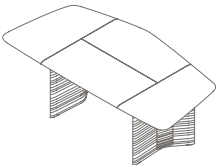

E

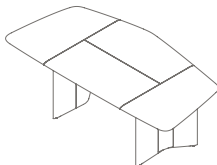

F

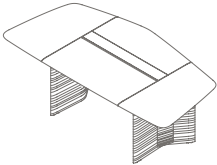

G

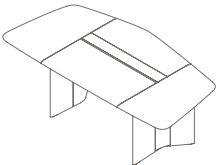

H

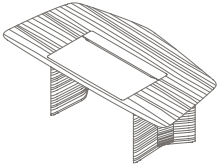

I

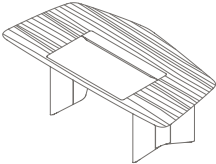

J

5644707 | A

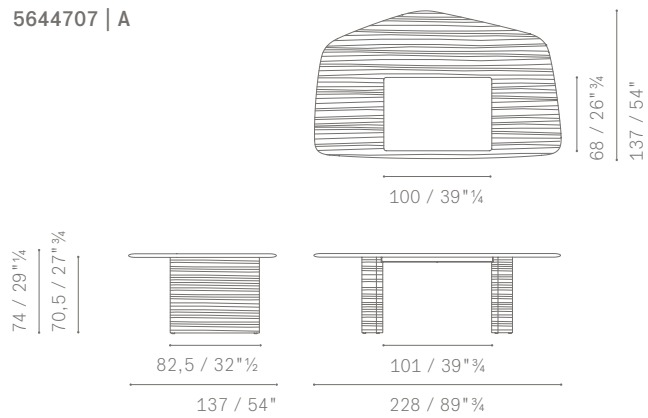

5644707 | B

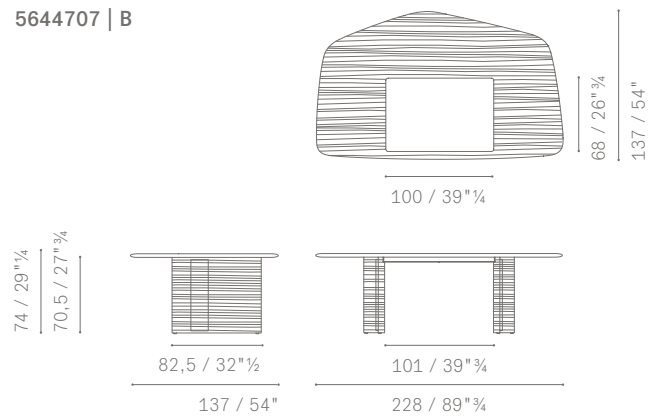

5644707 | C

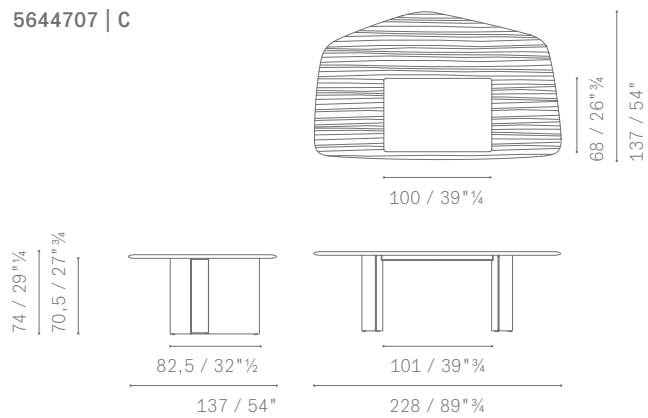

5644707 | D

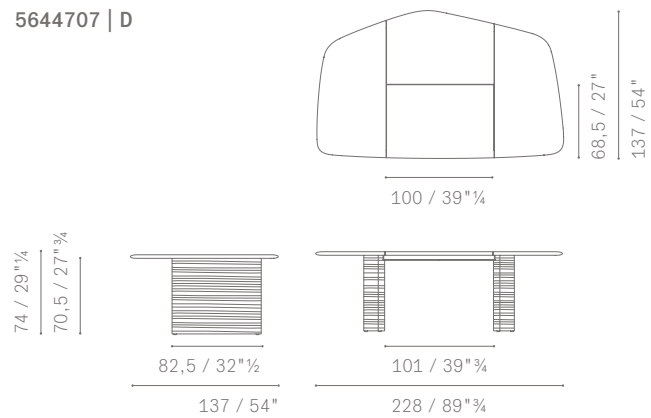

5644707 | E

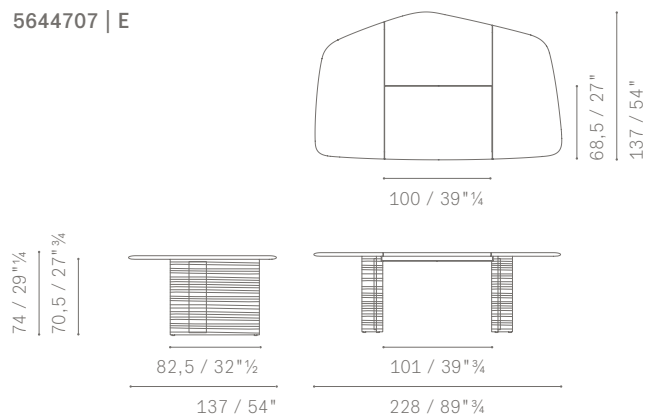

5644707 | F

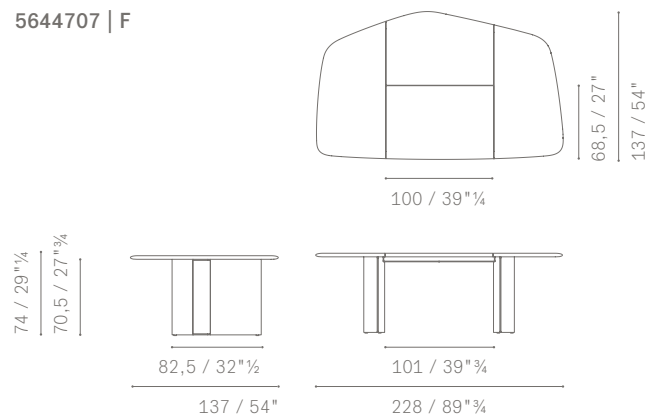

5644707 | G

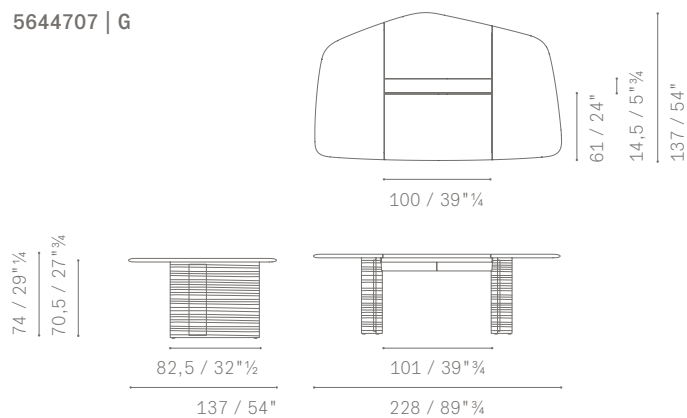

5644707 | H

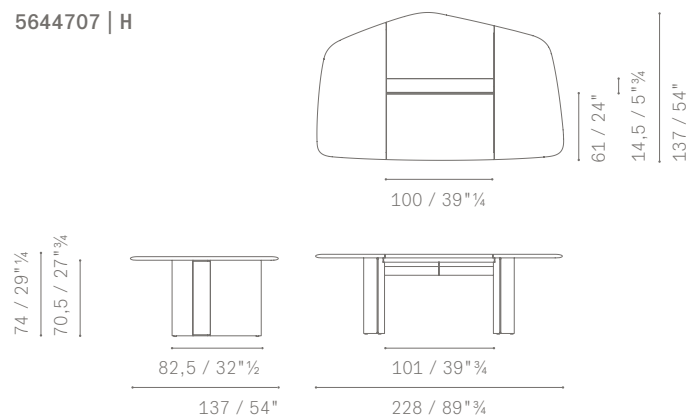

5644707 | I

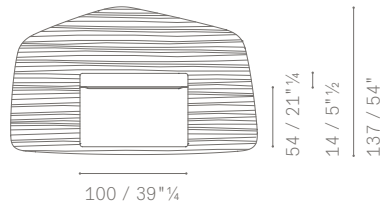

74 / 29 1/4
70,5 / 27 3/4

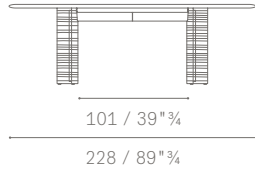
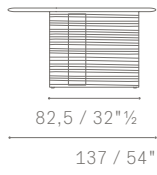

5644707 | J

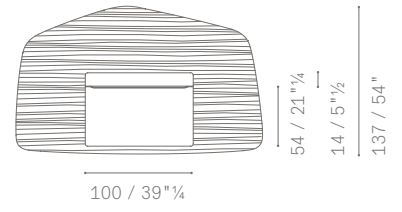

74 / 29 1/4
70,5 / 27 3/4

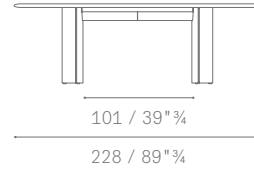
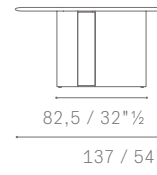

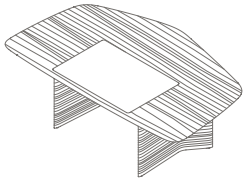

A

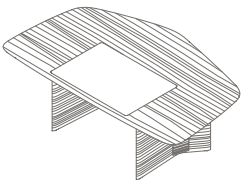

B

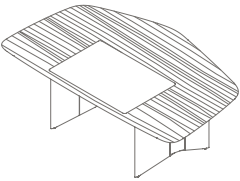

C

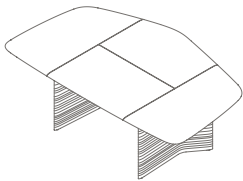

D

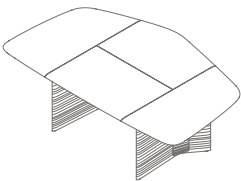

E

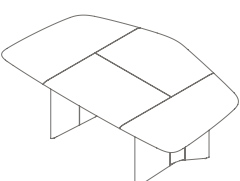

F

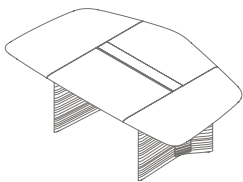

G

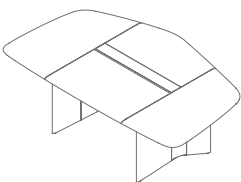

H

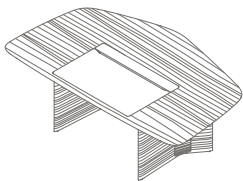

I

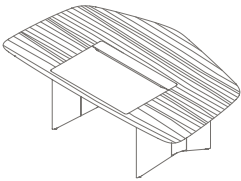

J

5644716 | A

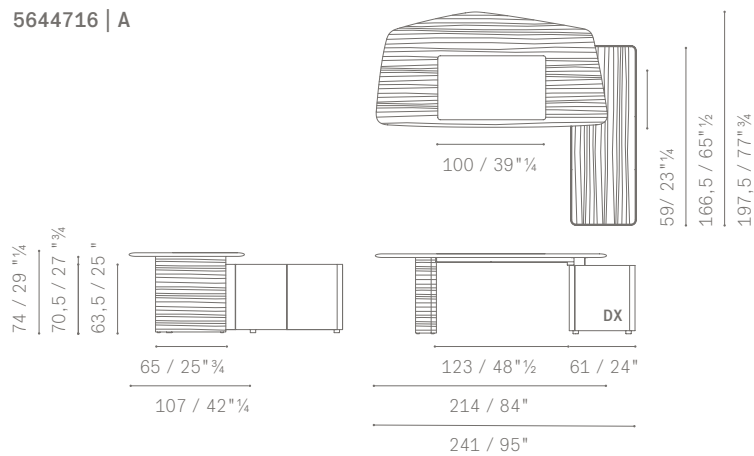

5644716 | B

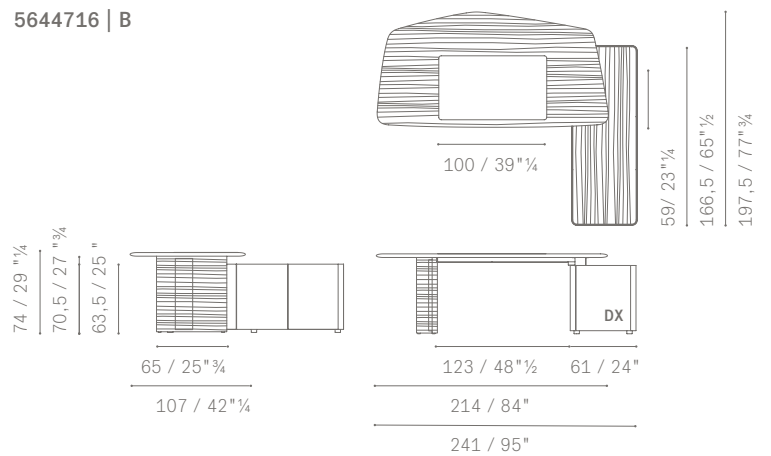

5644716 | C

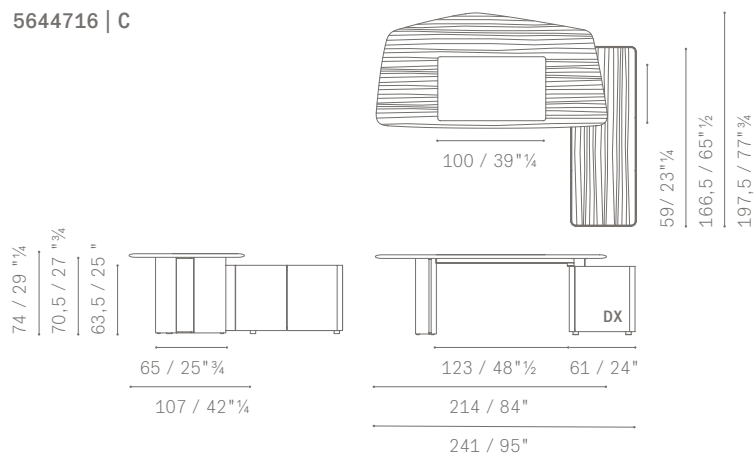

5644716 | D

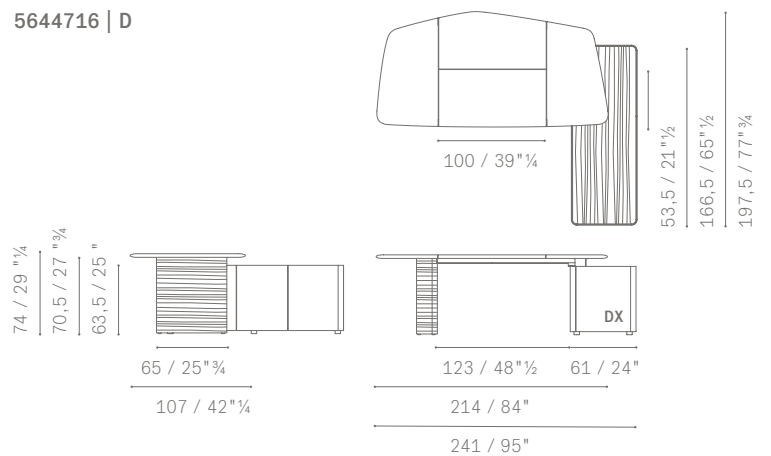

5644716 | E

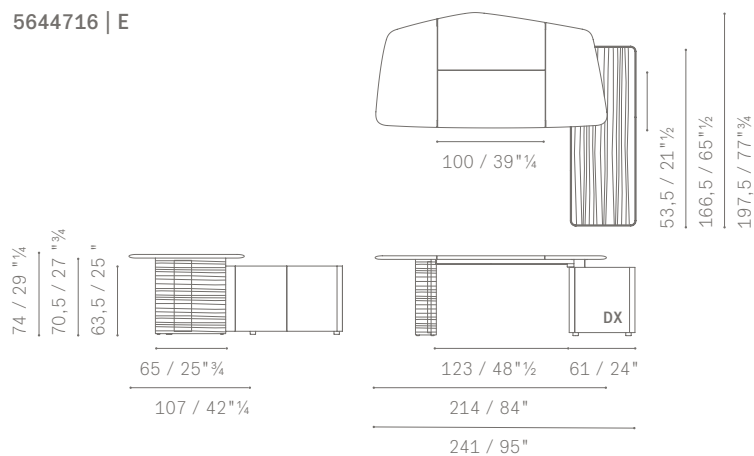

5644716 | F

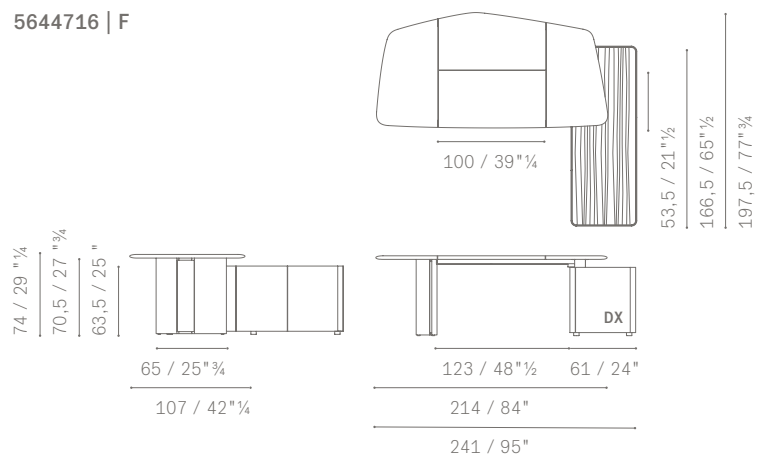

5644716 | G

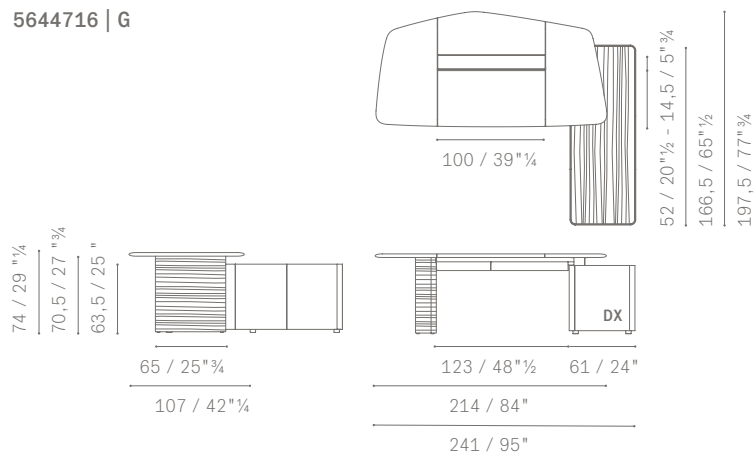

5644716 | H

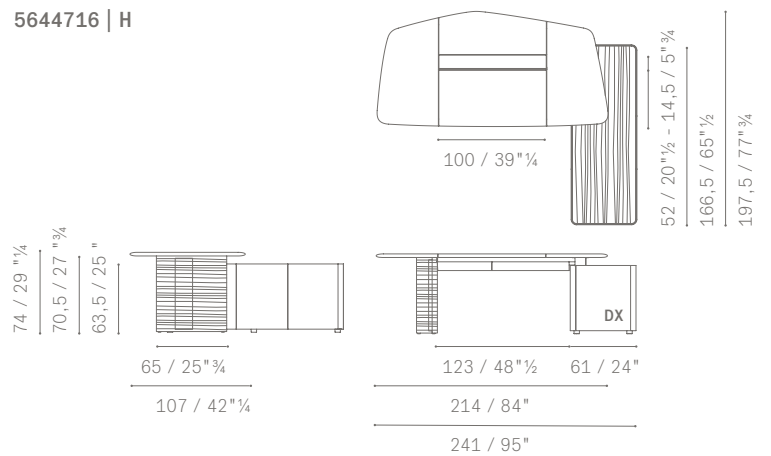

5644716 | I

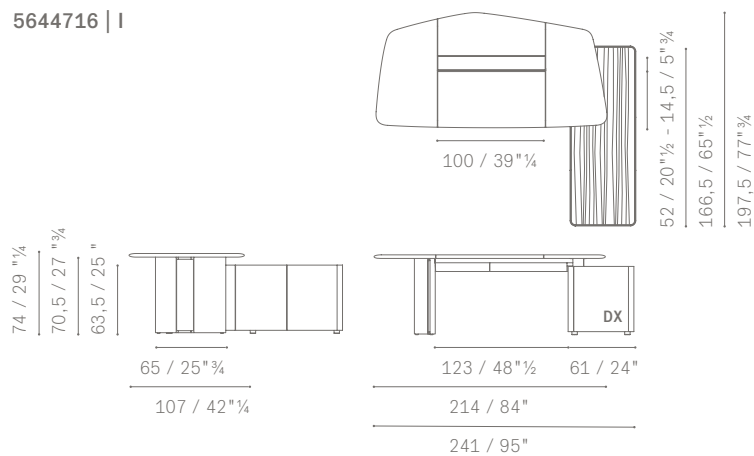

5644716 | J

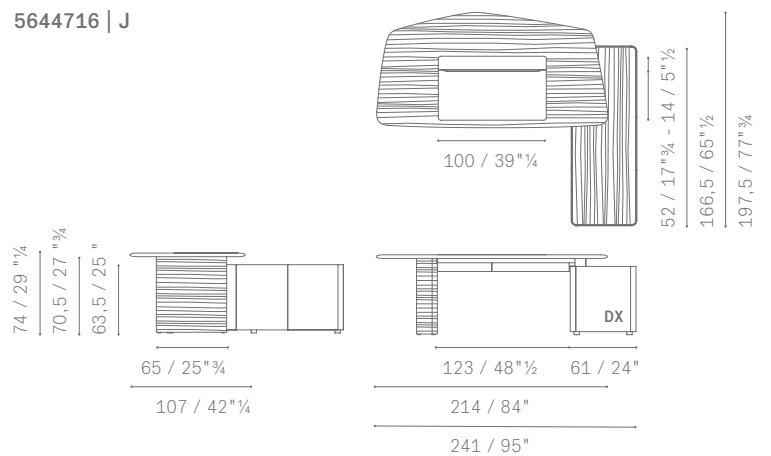

5644716 | K

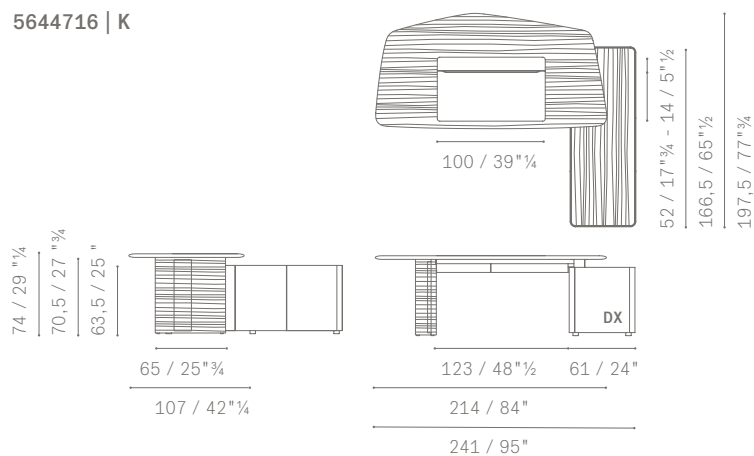

5644716 | L

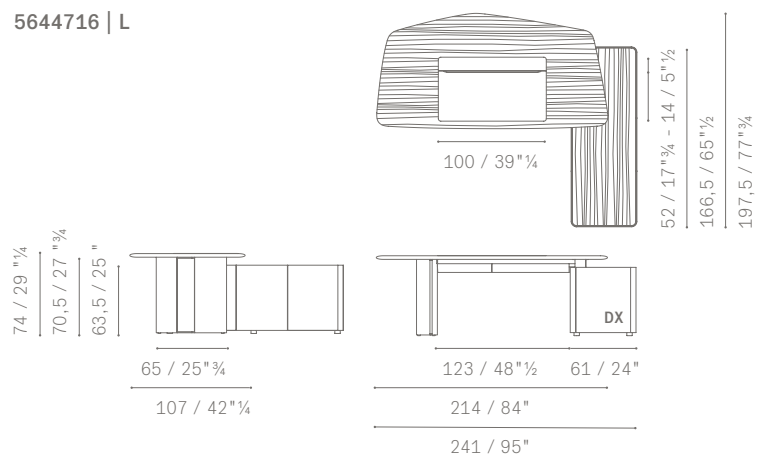

Legend: opening direction of drawers and door

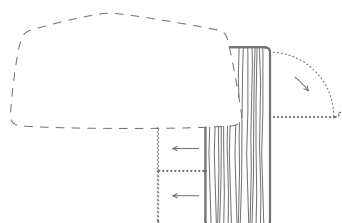

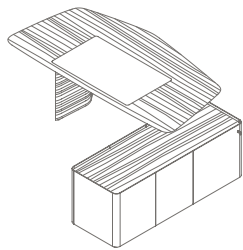

A

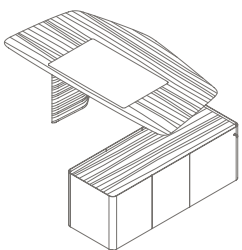

B

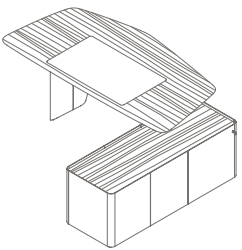

C

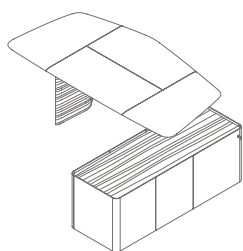

D

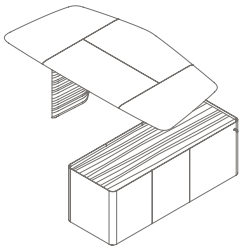

E

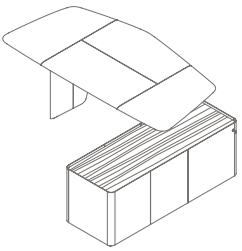

F

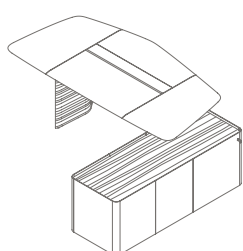

G

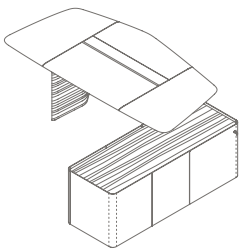

H

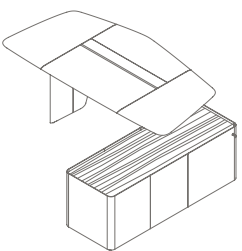

I

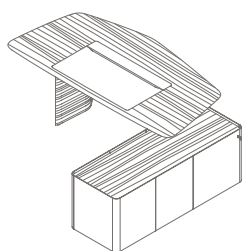

J

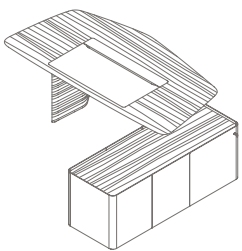

K

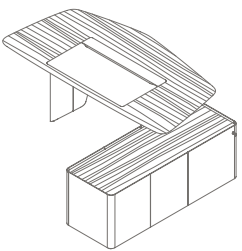

L

5644700 | A



74 / 29" $\frac{1}{4}$
70,5 / 27" $\frac{3}{4}$



45 / 17" $\frac{3}{4}$

68 / 26" $\frac{3}{4}$

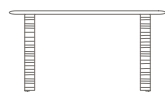

98 / 38" $\frac{1}{2}$

145 / 57"

5644700 | B



74 / 29" $\frac{1}{4}$
70,5 / 27" $\frac{3}{4}$



45 / 17" $\frac{3}{4}$

68 / 26" $\frac{3}{4}$



98 / 38" $\frac{1}{2}$

145 / 57"

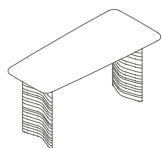

A

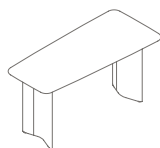

B

5644710 | A



145 / 57"

5644710 | B



145 / 57"

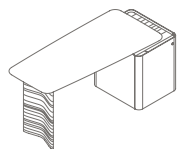
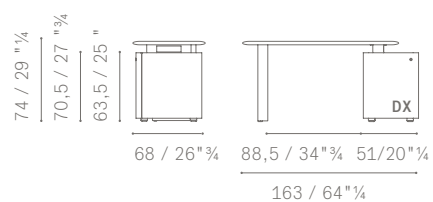
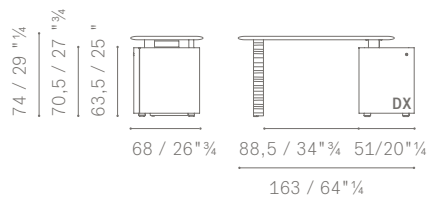

A

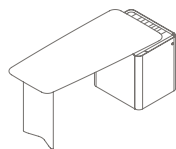
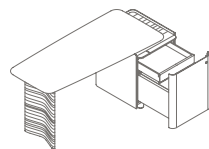

B

