

# Lloyd — Jean-Marie Massaud — 2016



Jean-Marie Massaud progetta Lloyd, sistema di contenitori e librerie a geometria variabile. Sottili bacchette di legno verticali formano griglie leggere, che scorrono per tutta la lunghezza su invisibili binari orizzontali. Ogni griglia è spostabile a piacere per creare sequenze sempre diverse. Una partitura cangiante di pieni e vuoti, di luci e ombre.

## CARATTERISTICHE TECNICHE

### Versioni.

- **Full:** versione consigliata. Completa di griglie scorrevoli.
- **Basic:** versione base. Senza griglie scorrevoli, comunque acquistabili separatamente fino al numero massimo previsto in ciascuna versione Full.

**Ripiani.** Realizzati in stratificato HPL impiallacciato in rovere naturale finitura piombo opaco (57).

**Montanti verticali.** Realizzati in fibra di legno a media densità rivestiti in cuoio:

- Saddle
- Saddle Extra

Cuoio con bordo a taglio netto rifinito con tinta protettiva in colore abbinato.

**Fianchi.** Sono chiusi da griglie fisse realizzate in massello di rovere.

**Griglie scorrevoli.** In massello di rovere, si muovono lungo binari intagliati nei ripiani e sono dotate di "pattini" in materiale plastico che diminuiscono l'attrito.

### Varianti disponibili.

- "Freestanding": presenta griglie scorrevoli su entrambi i lati (frontale e posteriore).
- "Wall": presenta griglie scorrevoli solo sul lato frontale mentre il lato posteriore, a contatto con il muro, è chiuso da un pannello in MDF verniciato nero opaco che, sul lato interno (fondo) può essere rivestito in cuoio.

### Fondo (solo varianti "Wall").

- Verniciato nero opaco
- Rivestito in cuoio

**Dettagli tecnici ed estetici.** Ogni griglia è un minuzioso lavoro di ebanisteria. Le bacchette sono intagliate in spessori diversi e poi incollate a mano una a una. Anche la tintura su di esse applicata, date le superfici ridotte, viene eseguita artigianalmente in più passaggi.

**Portata massima.** Non oltre i 15 Kg per ogni singolo vano.

## MODELLI LOW CABINET E BOOKCASE

**Piedi.** Realizzati in acciaio. Quelli esterni e in primo piano sono verniciati canna di fucile opaco mentre quelli centrali, più arretrati, sono laccati nero opaco.

Jean-Marie Massaud has designed Lloyd, a system of storage units and bookcases, with variable geometries. A series of thin vertical wooden rods form light grids that run from top to bottom on invisible horizontal guides. Each grid can be moved as desired creating different sequences each time. A fluctuating score of solids and voids, of light and shade.

## TECHNICAL FEATURES

### Versions.

- **Full:** suggested version. Inclusive of movable grids.
- **Basic:** basic version. Movable grids not included but purchasable separately up to the maximum number of grids provided for each Full version.

**Shelves.** Made of high pressure laminate in a natural oak veneer with a lead matte finish (57).

**Vertical uprights.** Made of MDF and covered with:

- Saddle leather
  - Saddle Extra leather
- Saddle-leather features clean-cut edges with a protective tone-on-tone finish.

**Sides.** They are closed by fixed grids made of solid oak wood.

**Movable grids.** Made of solid oak wood, they slide along guides carved on the shelves. The grids feature plastic glides which reduce friction between the surfaces.

### Available versions.

- "Freestanding": it features movable grids on both front and rear side.
- "Wall": it features movable grids only on the front side. The rear side, in contact with the wall, is closed by a matt black stained MDF panel which can also be covered with saddle-leather on the internal visible side (bottom).

### Bottom (only for the "Wall" versions).

- Matt black finish
- Covered with saddle-leather

**Technical and aesthetic details.** Each grid is a meticulous phase of fine woodworking. The solid oak rods are cut in different thicknesses and then individually glued by hand. Also, on the thin surfaces of the rods, the lead-coloured dye is applied by hand in several phases.

**Maximum load.** The weight must not exceed 15kg for each compartment.

## LOW CABINETS AND BOOKCASES

**Feet.** Made of steel, the external front feet feature a gunmetal grey matt finish while the central one, placed behind, are matt black lacquered.

#### MODELLI HIGH CABINET

---

**Base a cavalletto.** In massello di rovere finitura piombo opaco (57).

---

#### ACCESSORI E OPTIONAL

---

**Passaggio cavi opzionale.** Nelle varianti "Wall" dei modelli Low Cabinet è possibile richiedere la predisposizione per il passaggio dei cavi.

---

**Ripiano opzionale.** Autoportante e facilmente spostabile, è realizzato in alluminio e rivestito in cuoio con bordi tagliati a vivo e rifiniti con tinta abbinata e cera protettiva.

---

**Griglie scorrevoli (solo per le versioni Basic).** Disponibili in due differenti altezze: 20,5 cm e 36,5 cm.

#### HIGH CABINETS

---

**Trestle-shaped base.** Solid oak wood with a lead matte finish (57).

---

#### OPTIONAL ACCESSORIES

---

**Optional cable management system.** It is possible to fit the Low Cabinet "Wall" version with internal openings to run cables.

---

**Optional shelf.** Freestanding and easily movable, it is made of aluminium and covered with saddle-leather. The clean-cut edges are dyed and finished with protective wax.

---

**Movable grids (only for the Basic versions).** Available in two different heights: 20,5 cm and 36,5 cm.

---

## LLOYD FULL - LOW CABINETS

5607780  
Freestanding

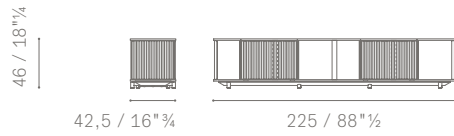

5607790  
Wall

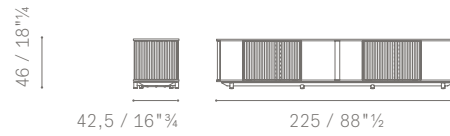

5607781  
Freestanding

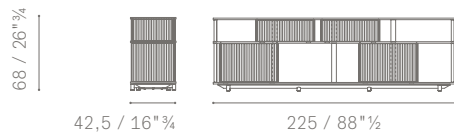

5607791  
Wall

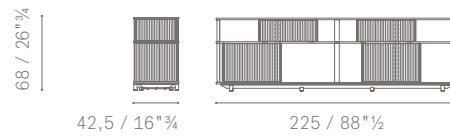

5607782  
Freestanding

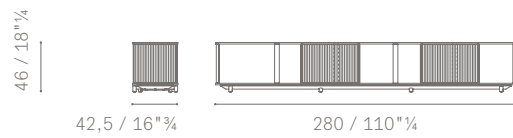

5607792  
Wall

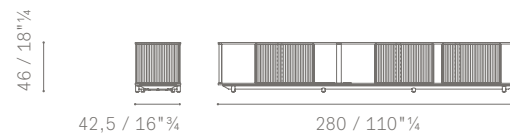

5607783  
Freestanding

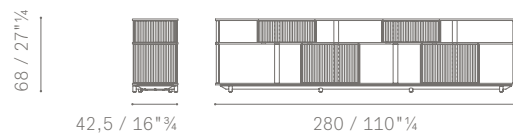

5607793  
Wall

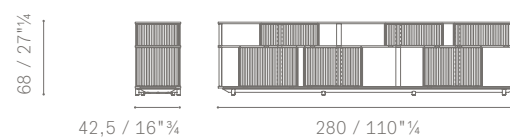

## LLOYD FULL - HIGH CABINETS

5607762  
Freestanding

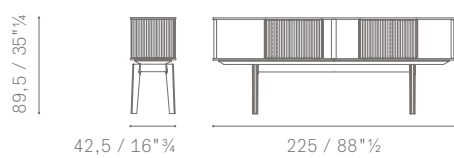

5607772  
Wall

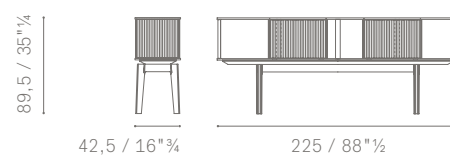

# LLOYD FULL - HIGH CABINETS

5607760  
Freestanding

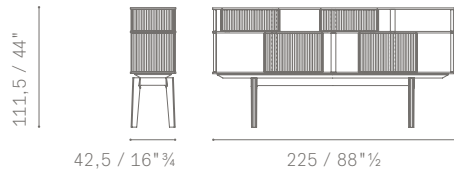

5607770  
Wall

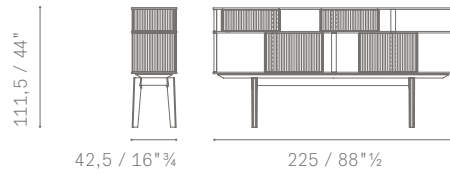

5607761  
Freestanding

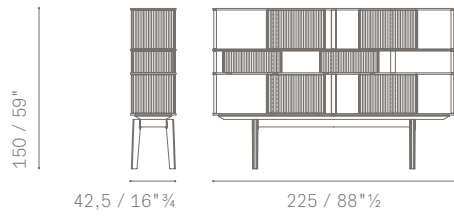

5607771  
Wall

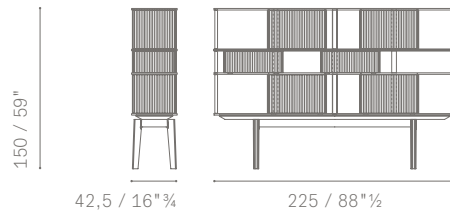

5607765  
Freestanding

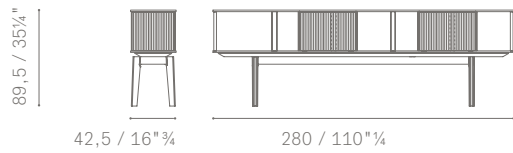

5607775  
Wall

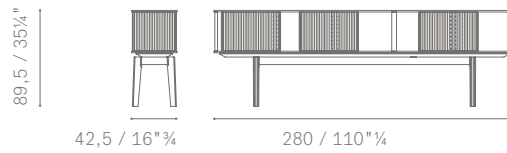

5607763  
Freestanding

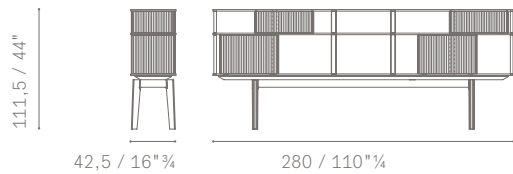

5607773  
Wall

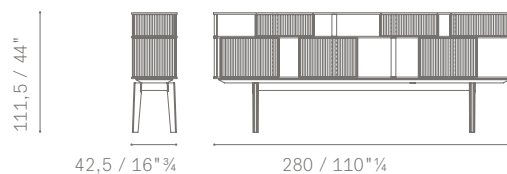

5607764  
Freestanding

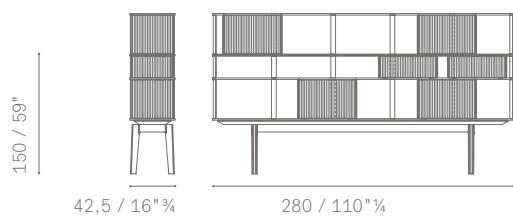

5607774  
Wall

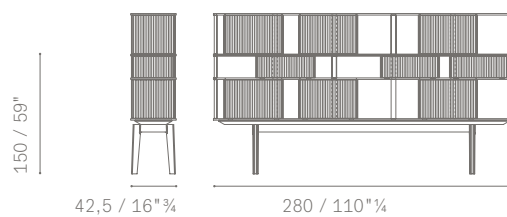

# LLOYD FULL - BOOKCASES

**5607785**  
Freestanding

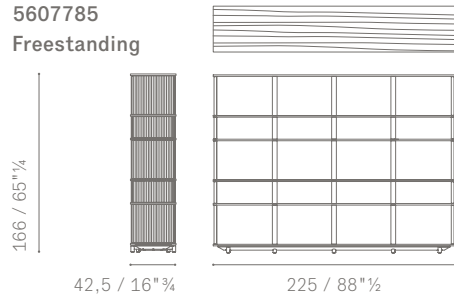

**5607795**  
Wall

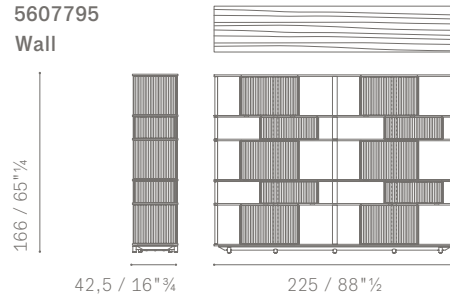

**5607786**  
Freestanding

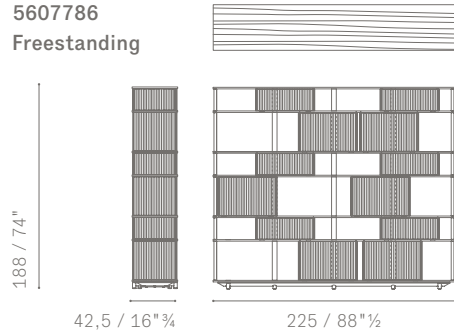

**5607796**  
Wall

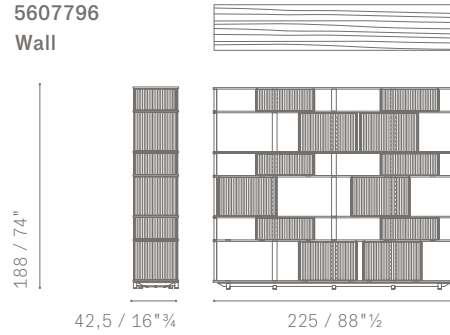

**5607787**  
Freestanding

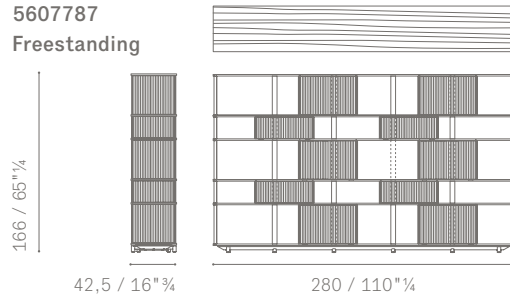

**5607797**  
Wall

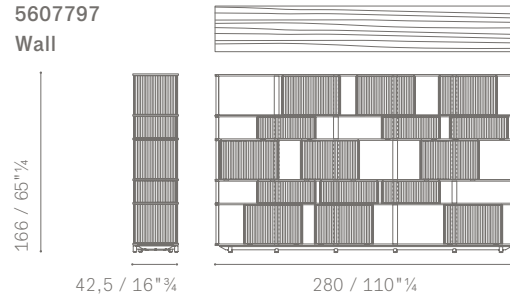

**5607788**  
Freestanding

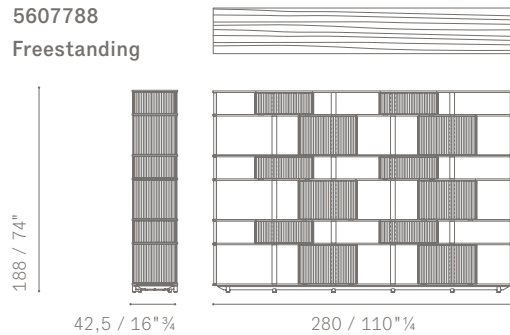

**5607798**  
Wall

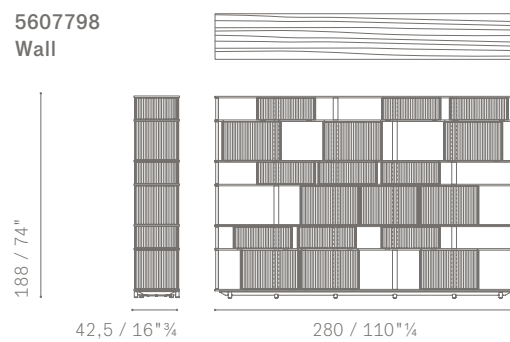

## OPTIONAL ACCESSORIES

### OPTIONAL SHELF

**5607430**



20 / 7 3/4



29,5 / 11 3/4    50,5 / 20"

## LLOYD BASIC - LOW CABINETS

5607780  
Freestanding

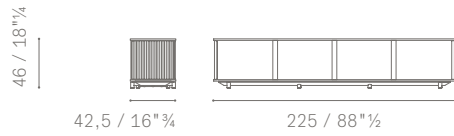

Maximum grids  
n. 4 h. 36,5 cm

5607790  
Wall

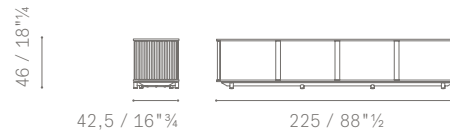

Maximum grids  
n. 2 h. 36,5 cm

5607781  
Freestanding

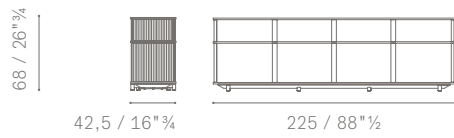

Maximum grids  
n. 4 h. 36,5 cm  
n. 4 h. 20,5 cm

5607791  
Wall

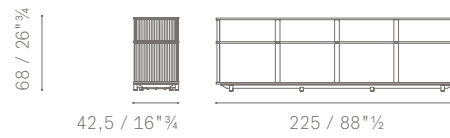

Maximum grids  
n. 2 h. 36,5 cm  
n. 2 h. 20,5 cm

5607782  
Freestanding

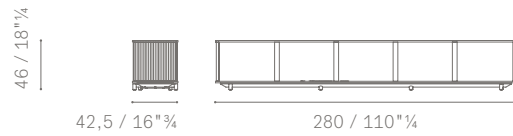

Maximum grids  
n. 4 h. 36,5 cm

5607792  
Wall

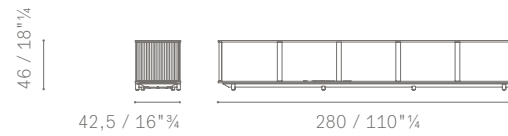

Maximum grids  
n. 3 h. 36,5 cm

5607783  
Freestanding

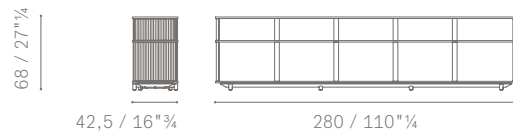

Maximum grids  
n. 4 h. 36,5 cm  
n. 4 h. 20,5 cm

5607793  
Wall

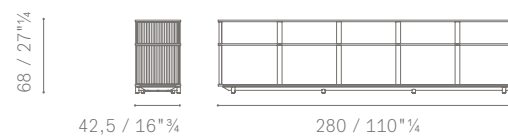

Maximum grids  
n. 3 h. 36,5 cm  
n. 3 h. 20,5 cm

## LLOYD BASIC - HIGH CABINETS

5607762  
Freestanding

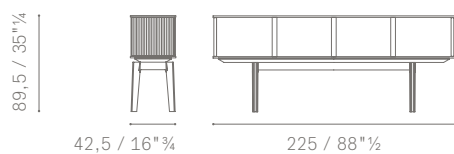

Maximum grids  
n. 4 h. 36,5 cm

5607772  
Wall

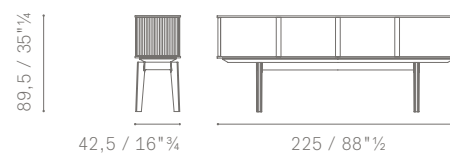

Maximum grids  
n. 2 h. 36,5 cm

# LLOYD BASIC - HIGH CABINETS

**5607760**  
Freestanding

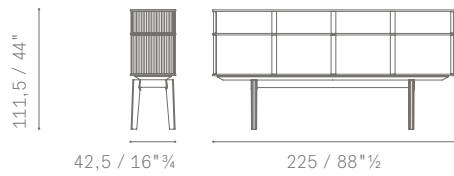

Maximum grids  
n. 4 h. 36,5 cm  
n. 4 h. 20,5 cm

**5607770**  
Wall

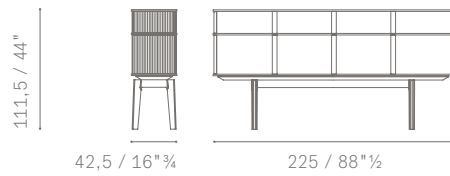

Maximum grids  
n. 2 h. 36,5 cm  
n. 2 h. 20,5 cm

**5607761**  
Freestanding

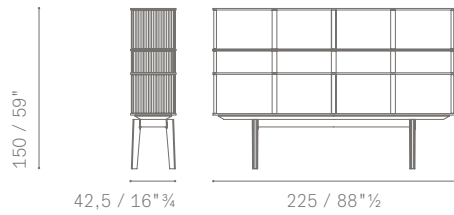

Maximum grids  
n. 8 h. 36,5 cm  
n. 4 h. 20,5 cm

**5607771**  
Wall

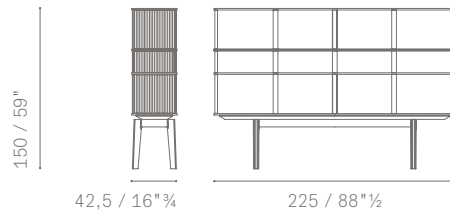

Maximum grids  
n. 4 h. 36,5 cm  
n. 2 h. 20,5 cm

**5607765**  
Freestanding

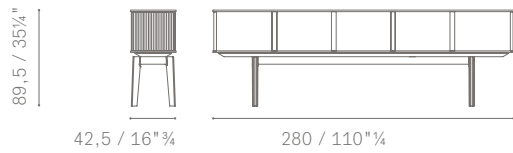

Maximum grids  
n. 4 h. 36,5 cm

**5607775**  
Wall

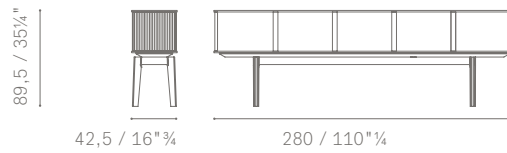

Maximum grids  
n. 3 h. 36,5 cm

**5607763**  
Freestanding

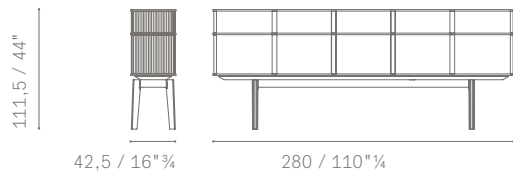

Maximum grids  
n. 4 h. 36,5 cm  
n. 4 h. 20,5 cm

**5607773**  
Wall

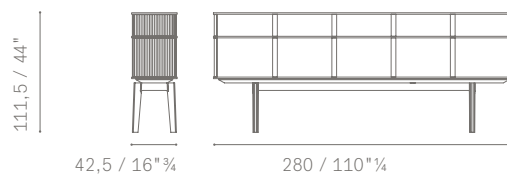

Maximum grids  
n. 3 h. 36,5 cm  
n. 3 h. 20,5 cm

**5607764**  
Freestanding

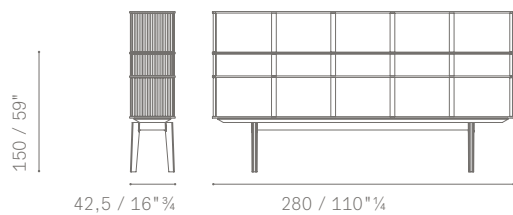

Maximum grids  
n. 8 h. 36,5 cm  
n. 4 h. 20,5 cm

**5607774**  
Wall

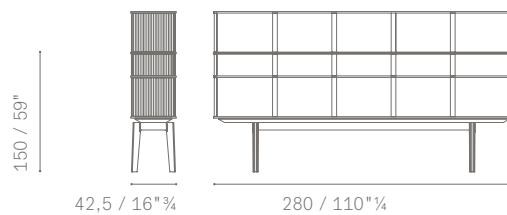

Maximum grids  
n. 6 h. 36,5 cm  
n. 3 h. 20,5 cm

# LLOYD BASIC - BOOKCASES

**5607785**  
Freestanding

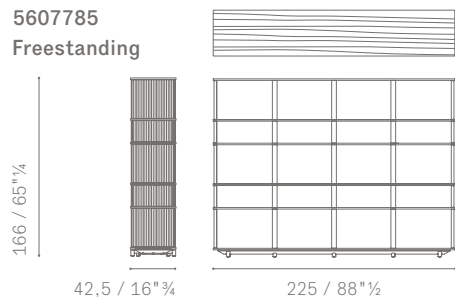

Maximum grids  
n. 12 h. 36,5 cm  
n. 8 h. 20,5 cm

**5607795**  
Wall

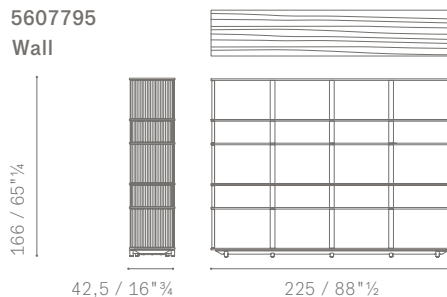

Maximum grids  
n. 6 h. 36,5 cm  
n. 4 h. 20,5 cm

**5607786**  
Freestanding

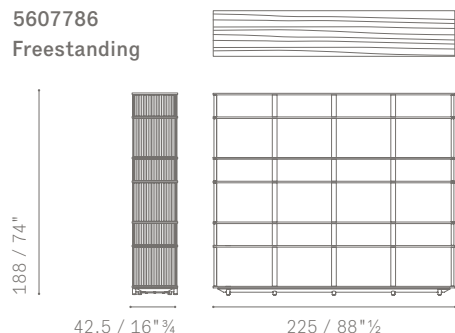

Maximum grids  
n. 12 h. 36,5 cm  
n. 12 h. 20,5 cm

**5607796**  
Wall

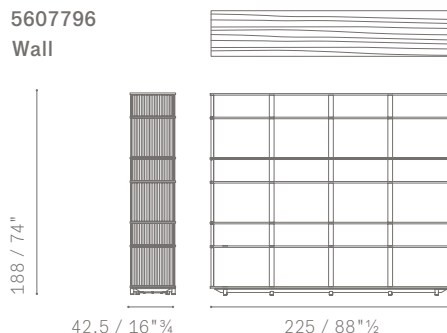

Maximum grids  
n. 6 h. 36,5 cm  
n. 6 h. 20,5 cm

**5607787**  
Freestanding

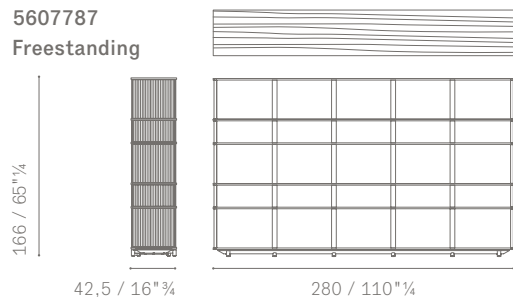

Maximum grids  
n. 12 h. 36,5 cm  
n. 8 h. 20,5 cm

**5607797**  
Wall

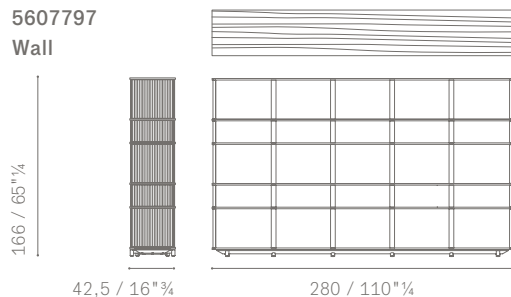

Maximum grids  
n. 9 h. 36,5 cm  
n. 6 h. 20,5 cm

**5607788**  
Freestanding

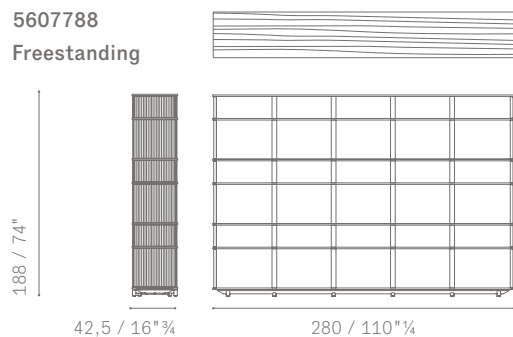

Maximum grids  
n. 12 h. 36,5 cm  
n. 12 h. 20,5 cm

**5607798**  
Wall

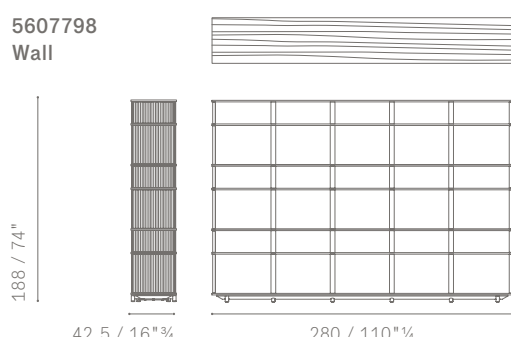

Maximum grids  
n. 9 h. 36,5 cm  
n. 9 h. 20,5 cm

## OPTIONAL ACCESSORIES

### OPTIONAL SHELF

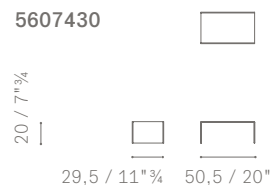

### OPTIONAL GRIDS

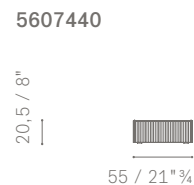
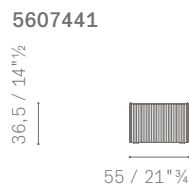



# SPECIFICHE TECNICHE / TECHNICAL SPECIFICATIONS

## VERSIONI, PORTATA E CAPIENZA / VERSIONS, MAXIMUM LOAD AND CAPACITY

### LOW CABINETS

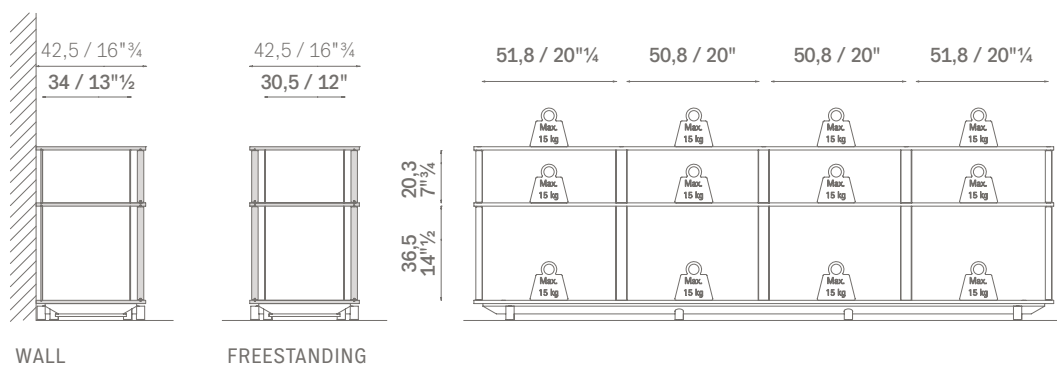

WALL

FREESTANDING

### HIGH CABINETS

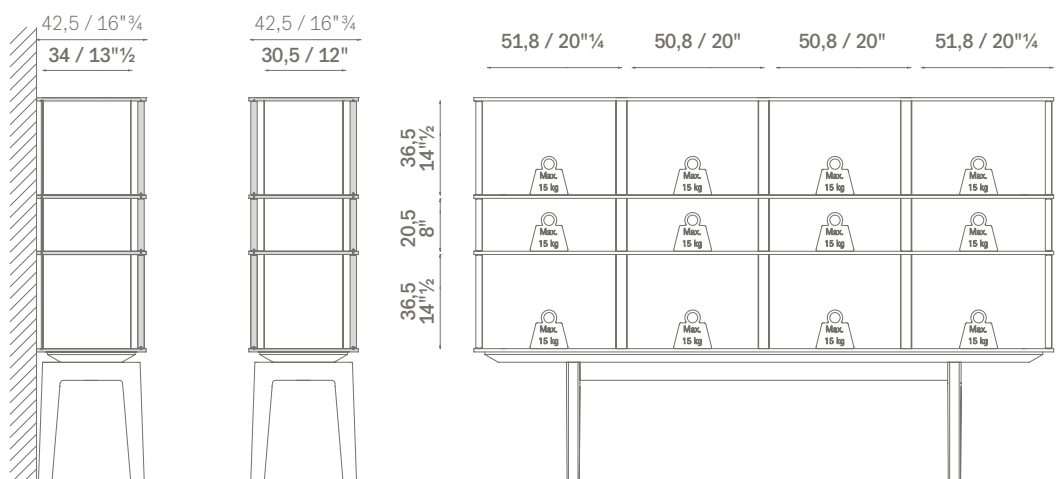

WALL

FREESTANDING

### BOOKCASES

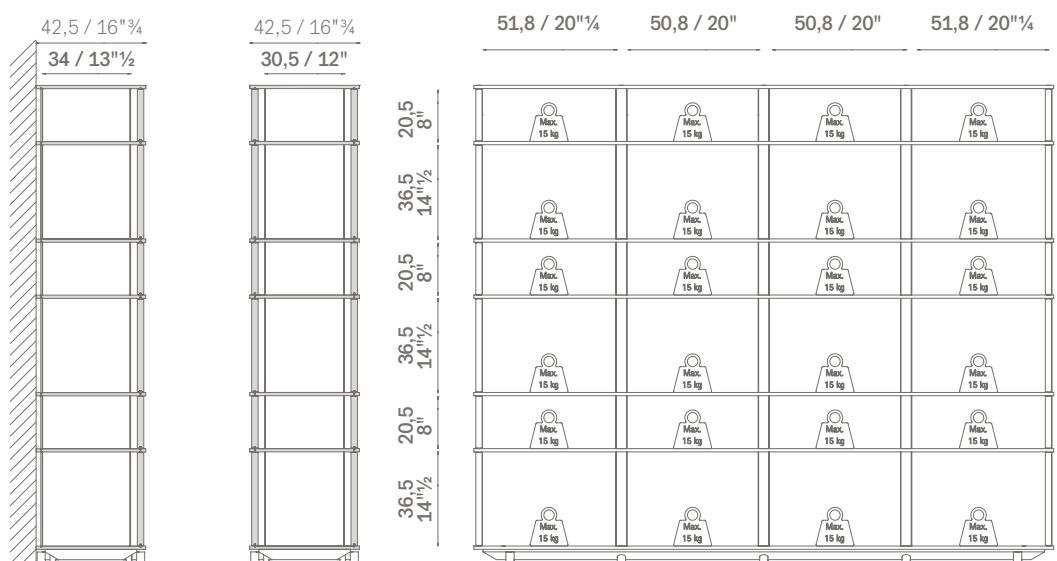

WALL

FREESTANDING

## SPECIFICHE TECNICHE / TECHNICAL SPECIFICATIONS

### PASSAGGIO CAVI / CABLE MANAGEMENT SYSTEM

#### VISTA FRONTALE - FRONT VIEW

LOW CABINET 225X46 WALL

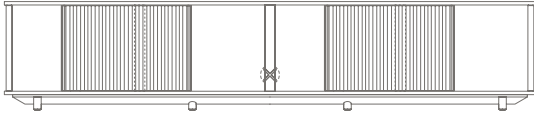

LOW CABINET 225X68 WALL

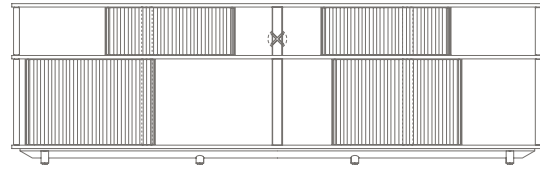

LOW CABINET 280X46 WALL

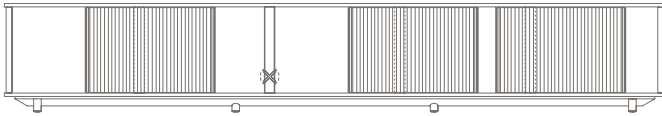

LOW CABINET 280X68 WALL

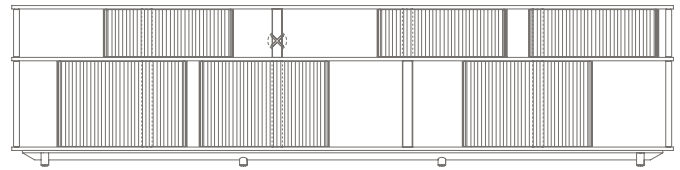

⊗ POSIZIONAMENTO PASSACAVI / CABLE SYSTEM PLACEMENT

#### VISTA RETRO - REAR VIEW

